

9th Illia O. Teplytskyi Workshop on Computer Simulation in Education

Arnold E. Kiv¹, Serhiy O. Semerikov^{2,3,4,5}, Vladimir N. Soloviev² and Andrii M. Striuk³

¹Ben-Gurion University of the Negev, P.O.B. 653, Beer Sheva, 8410501, Israel

²Kryvyi Rih State Pedagogical University, 54 Gagarin Ave., Kryvyi Rih, 50086, Ukraine

³Kryvyi Rih National University, 11 Vitalii Matusevych Str., Kryvyi Rih, 50027, Ukraine

⁴Institute for Digitalisation of Education of the National Academy of Educational Sciences of Ukraine, 9 M. Berlynskoho Str., Kyiv, 04060, Ukraine

⁵University of Educational Management, 52A Sichovykh Striltsiv Str., Kyiv, 04053, Ukraine

Abstract

This is an introductory text to a collection of selected papers from the 9th Illia O. Teplytskyi Workshop on Computer Simulation in Education (CoSinE 2021), held in Kherson, Ukraine, on the October 1, 2021. The volume presents the contributions to the workshops affiliated with the ICTERI 2021: the 17th International Conference on ICT in Education, Research, and Industrial Applications.

Keywords

ICTERI 2021, CoSinE 2021

1. CoSinE 2021 as is

CoSinE (Computer Simulation in Education) is a peer-reviewed international workshop focusing on theory and practice of computer simulation in education. This workshop was founded by Illia O. Teplytskyi (1941–2018), whose pioneering works in the field of computer simulation in education inspires us.



CoSinE topics of interest since 2019 [1, 2, 3] are:

- Computer simulation in STEM education

CoSinE 2021: 9th Illia O. Teplytskyi Workshop on Computer Simulation in Education, co-located with the 17th International Conference on ICT in Education, Research, and Industrial Applications: Integration, Harmonization, and Knowledge Transfer (ICTERI 2021), October 1, 2021, Kherson, Ukraine

✉ kiv.arnold20@gmail.com (A. E. Kiv); semerikov@gmail.com (S. O. Semerikov); vnsoloviev2016@gmail.com (V. N. Soloviev); andrey.n.stryuk@gmail.com (A. M. Striuk)

🌐 <https://ieeexplore.ieee.org/author/37087598865> (A. E. Kiv); <https://kdpu.edu.ua/semerikov> (S. O. Semerikov); <https://kdpu.edu.ua/personal/vmsoloviov.html> (V. N. Soloviev);

<http://mpz.knu.edu.ua/pro-kafedru/vikladachi/224-andrii-striuk> (A. M. Striuk)

🆔 0000-0002-0991-2343 (A. E. Kiv); 0000-0003-0789-0272 (S. O. Semerikov); 0000-0002-4945-202X (V. N. Soloviev); 0000-0001-9240-1976 (A. M. Striuk)



© 2022 Copyright for this paper by its authors. Use permitted under Creative Commons License Attribution 4.0 International (CC BY 4.0).

CEUR Workshop Proceedings (CEUR-WS.org)



Figure 1: Illia O. Teplytskyi.

- AI in education
- Educational data mining and learning analytics
- Learning environments models
- Learning virtualization
- Modelling systems in education

This volume represents the proceedings of the 9th Illia O. Teplytskyi Workshop on Computer Simulation in Education (CoSinE 2021), held in Kherson, Ukraine, on the October 1, 2021. It comprises 9 contributed papers [4, 5, 6, 7, 8, 9, 10, 11, 12] that were carefully peer-reviewed and selected from 50 submissions. Each submission was reviewed by at least 3, and on the average 3.1, program committee members. The accepted papers present the state-of-the-art overview of successful cases and provides guidelines for future research.

2. CoSinE 2021 Program Committee

- *Program Committee Co-Chairs:*
 - **Vadim Ermolayev**, Zaporizhzhia National University, Ukraine
 - **David Esteban**, TECHFORCE, Spain
 - **Arnold Kiv**, Ben-Gurion University of the Negev, Israel
 - **Serhiy Semerikov**, Kryvyi Rih State Pedagogical University, Ukraine
 - **Vladimir Soloviev**, Kryvyi Rih State Pedagogical University, Ukraine
 - **Andrii Striuk**, Kryvyi Rih National University, Ukraine
- *Program Committee members and additional reviewers:*
 - **Leon Andretti Abdillah**, Bina Darma University, Indonesia
 - **Spencer A. Benson**, Education Innovations International, LLC and University of Maryland, United States
 - **Liudmyla Bilousova**, Independent Researcher, Ukraine
 - **Roman Danel**, VŠTE České Budějovice, Czechia
 - **Helena Fidlerová**, MTF STU Trnava, Slovakia
 - **Irina Georgescu**, Academy of Economic Studies, Romania
 - **Liudmyla E. Gryzun**, Simon Kuznets Kharkiv National University of Economics, Ukraine
 - **Vita Hamaniuk**, Kryvyi Rih State Pedagogical University, Ukraine
 - **Oleksii Ignatenko**, Institute of Software Systems of the NAS of Ukraine, Ukraine
 - **Michail Kalogiannakis**, University of Crete, Greece
 - **Oleksandr Kolgatin**, Simon Kuznets Kharkiv National University of Economics, Ukraine
 - **Elena Komarova**, Immanuel Kant Baltic Federal University, Russia
 - **Hennadiy Kravtsov**, Kherson State University, Ukraine
 - **Piotr Lipiński**, Technical University of Lodz, Poland
 - **Alex Merzlykin**, Kryvyi Rih Educational Complex No 129 “Gymnasium-Lyceum of Academic Direction”, Ukraine
 - **Ranesh Kumar Naha**, University of Tasmania, Australia
 - **Yuliya Nosenko**, Institute of Information Technologies and Learning Tools of the NAES of Ukraine, Ukraine
 - **Sumitra Nuanmeesri**, Suan Sunandha Rajabhat University, Thailand

- **Laima Okuneviciute Neverauskiene**, Vilnius Gediminas Technical University, Lithuania
- **Liubov Panchenko**, National Technical University of Ukraine “Igor Sikorsky Kyiv Polytechnic Institute”, Ukraine
- **Stamatios Papadakis**, University of Crete, Greece
- **Olga Pinchuk**, Institute of Information Technologies and Learning Tools of the NAES of Ukraine, Ukraine
- **Oleg Pursky**, Kyiv National University of Trade and Economics, Ukraine
- **Nina Rizun**, Gdańsk University of Technology, Poland
- **Zarema Seidametova**, Crimean Engineering and Pedagogical University, Ukraine
- **Oleksandra Sokolyuk**, Institute of Information Technologies and Learning Tools of the NAES of Ukraine, Ukraine
- **Kateryna Vlasenko**, Donbas State Engineering Academy, Ukraine
- **Longkai Wu**, National Institute of Education, Singapore
- **Yuliia Yechkalo**, Kryvyi Rih National University, Ukraine

3. CoSinE 2021 workshop overview

3.1. Session I: Modelling systems in education. Educational data mining and learning analytics

The objectives of work “Computational modelling of stochastic processes for learning research” [10] by Oleksandr H. Kolgatin (figure 2), Larisa S. Kolgatina and Nadiia S. Ponomareva were to use computer-based statistical modelling for comparison and systematisation of various approaches to non-parametric null hypothesis significance testing. Statistical model for simulation of null hypothesis significance testing has been built for educational purpose. Fisher’s angular transformation, Chi-square, Mann-Whitney and Fisher’s exact tests were analysed. Appropriate software has been developed and gave authors possibility to suggest new illustrative materials for describing the limitations of analysed tests. Learning researches as the method of understanding inductive statistics have been suggested taking into account that modern personal computers provide acceptable time of the simulations with high precision. The obtained results showed low power of the most popular non-parametric tests for small samples. Students can’t analyse the test power at traditional null hypothesis significance testing, because the real differences between samples are unknown. Therefore, it is necessary to change the accents in Ukrainian statistical education, including PhD studies, from using null hypothesis significance testing to statistical modelling as a modern and effective method of proving the scientific hypotheses. This conclusions correlate with observed scientific publications and the recommendation of the American Statistical Association.

This article highlights further research by the authors, begun in [13, 14, 15, 16, 17, 18, 19, 20, 21].

The problems of synchronized curriculum shaping are discussed in the paper “A Petri net-based simulation of synchronized curriculum for IT-specialists’ training” [7] by Lyudmyla I. Bilousova and Liudmyla E. Gryzun (figure 3) in the context of the challenges of contemporary

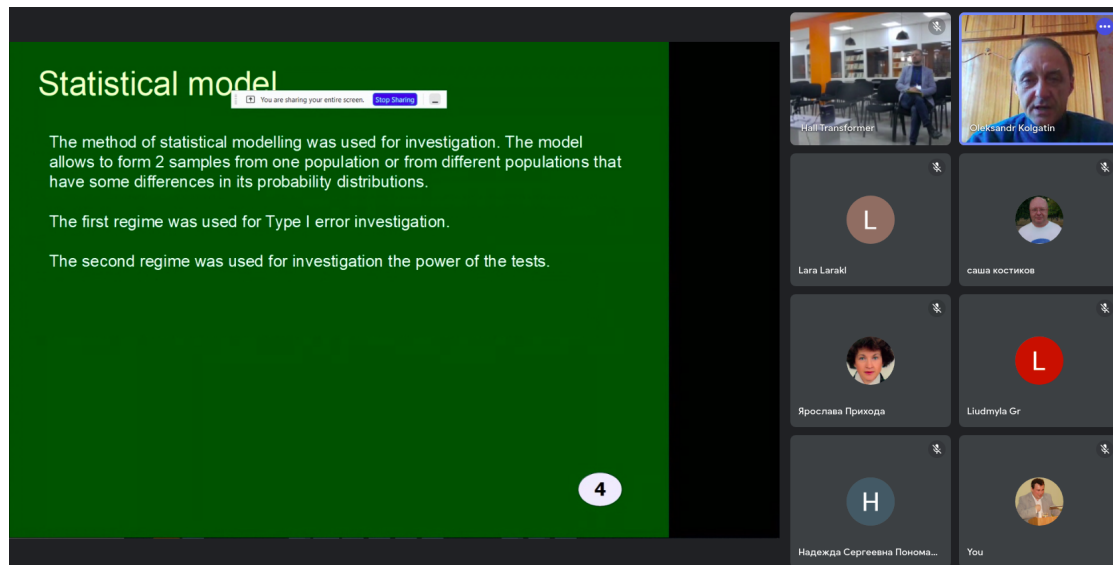

Figure 2: Presentation of paper [10].

IT specialists' training in terms of permanent evolution and rapid expansion of computing. The authors' technique of the curriculum simulation based on Petri net applying is presented. The theoretical framework which allowed us to elaborate the technique includes some didactical fundamentals of curriculum design and academic disciplines structuring as well as the theoretical basics of Petri nets in terms of their significant facilities for different processes synchronization. The technique of academic disciplines structuring based on frame model of knowledge representation is covered as a chain of stages which results in the net of disciplines modules (frames) including the proper learning elements along with preserving and spreading links between them. In order to solve the problem of synchronization of the learning elements mastering throughout the academic disciplines with regard of the established links in the frames, it is offered the practically-driven approach to curriculum modeling based on Petri nets simulation. The different types of the precedence relations for the learning elements (inputs and outputs of the frames) were distinguished. Using these precedence relations, we managed to simulate through Petri nets a learning element itself and the process of its mastering. Using the operations of Petri nets modifications and learning elements' connections of different types, we could obtain a model of a curriculum discipline module and finally – a curriculum discipline model. Built Petri nets models represent all the evolution of the learning elements mastering by students in the curriculum courses. Synchronization of their mastering is guaranteed by the rules of Petri net execution and modifications. The peculiarities of the offered technique are analyzed. The benefits in terms of applying such a simulation to the building of synchronized curriculum for IT-specialists training are formulated. The prospects of the research are outlined in the lines of using the obtained results for special software development.

This article highlights further research by the authors, begun in [22, 23, 24, 25, 26, 27, 28].

In this paper "The algorithm for knowledge assessment based on the Rusch model" [5] by

17th International Conference on ICT in Education, Research, and Industrial Applications (ICTERI 2021), Kherson, Ukraine Sept 28-Oct 02, 2021

9th Illia O. Teplytskyi Workshop (CoSinE 2021)
on Computer Simulation in Education
<https://easychair.org/smart-program/ICTERI-2021/>

A Petri net-based simulation of synchronized curriculum for IT-specialists' training

Lyudmyla Bilousova,
 Full Professor, Independent researcher, Kharkiv, Ukraine

Liudmyla Gryzun,
 Full Professor, Information Systems Department,
 Simon Kuznets National University of Economics, Kharkiv, Ukraine

Figure 3: Presentation of paper [7].

Alexander A. Kostikov (figure 4), Kateryna V. Vlasenko, Iryna V. Lovianova, Sergii V. Volkov and Evgeny O. Avramov the algorithm for adaptive testing of students' knowledge in distance learning and an assessment of its effectiveness in the educational process has been proposed. The paper provides an overview of the results of the application of modern test theory, a description and block diagram of the proposed algorithm and the results of its application in the real educational process. The effectiveness of using this algorithm for the objective assessment of students' knowledge has been experimentally shown.

This article highlights further research by the authors, begun in [29, 30, 31, 32, 33, 34, 35, 36, 37, 38, 39, 40, 41, 42, 43, 44, 45, 46].

The algorithm for knowledge assessment based on the Rush model

Alexander A. Kostikov¹, Kateryna Vlasenko^{2,3}, Iryna V. Lovyanova⁴, Sergii V. Volkov⁵ and Evgeny O. Avramov¹

1 Donbass State Engineering Academy.
 2 National University of "Kyiv Mohyla Academy".
 3 Limited Liability Company Technical University "Metinvest Polytechnic".
 4 Kryvyi Rih State Pedagogical University.
 5 The Institute of Chemical Technologies of the East Ukrainian Volodymyr National University.

Figure 4: Presentation of paper [5].

Nowadays, there is a wide variety of scientific articles. Due to this fact, it is hard to read and be familiar with all of them. Also, it is hard for a young scientist to understand the complicated

terms and methods that are used in a specific research domain. This problem was partially solved by bibliographic management software and other specific software. The article “Ontology-based learning environment model of scientific studies” [8] by Roman A. Tarasenko, Stanislav A. Usenko, Yevhenii B. Shapovalov (figure 5), Viktor B. Shapovalov, Adrian Paschke and Iryna M. Savchenko is devoted to the development of an approach for structuration and processing sets of studies using the IT Platform Polyhedron using an ontology-based hierarchical model. In its structure, the ontological graph is complex because it has additional branches from child nodes. The basis of our solution was IMRAD which has been represented in the view of nodes. Those nodes have been connected with specific representations of IMRAD elements. Specific articles have been represented in the view of leaf nodes. That could help to use the taxonomies for the structuration of the articles. Each data block is in the form of separate attributes of the ontological node. The proposed solution allows to obtain structured sets of studies and to separate their characteristics. Thus, the proposed ontology provides the possibility to view all methods, measured parameters, etc. of the studies in a graph node structure and use them to find the studies where they were used.

This article highlights further research by the authors, begun in [47, 48, 49, 50, 51, 52, 53, 54, 55, 56, 57, 58].

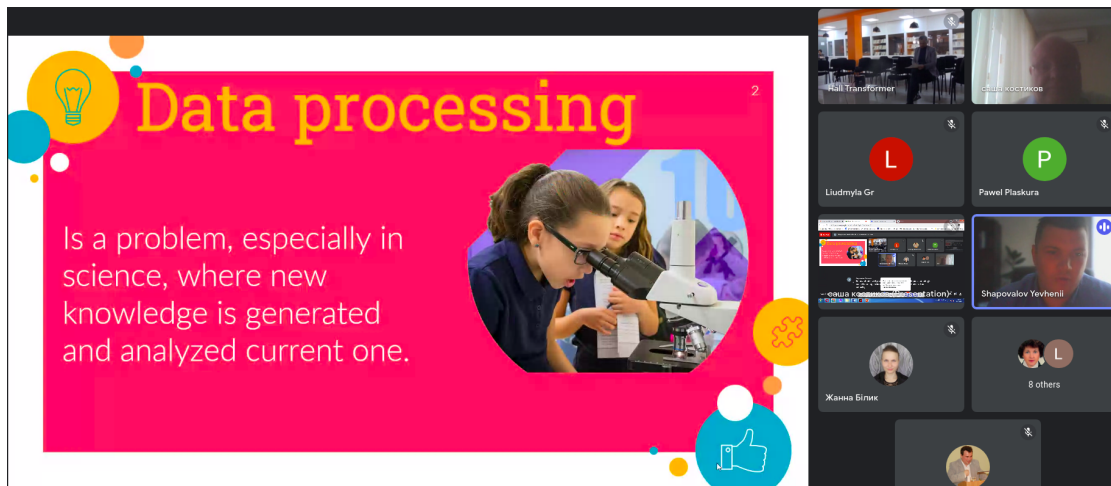

Figure 5: Presentation of paper [8].

3.2. Session II: Learning virtualization. AI in education

Any person, not even a financier, should be knowledgeable in the field of personal finance management. As a result of the survey, it was concluded that schoolchildren and students should be interested in the study of personal finance, even within other disciplines in the form of separate sections. Successful personal experience and knowledge of the teacher in the field of personal finance is an important component of the effectiveness of the formation of competence of pupils, students, and adults in the field of personal finance. Business simulators come in handy here. That is why Dmytro S. Antoniuk (figure 6), Tetiana A. Vakaliuk, Vladyslav V.

Didkivskiy, Oleksandr Yu. Vizghalov, Oksana V. Oliinyk and Valentyn M. Yanchuk, the authors of article “Using a business simulator with elements of machine learning to develop personal finance management skills” [4] developed a business simulator for the development of personal finance management skills, which was developed in the form of a web service. The main features of this simulator, which are presented in different sections of the simulator, are considered. It is shown what skills of personal finance management are developed using this business simulator. Since this simulator was designed to develop personal finance management skills, an attempt was made to apply machine-learning elements to make this business simulator work even better. The proposed simulator can be used in the future to teach the elements of personal finance management to people who are not sufficiently knowledgeable in the field of such finance. Moreover, the web application can be useful even for school-age children, so the simulator can complement the educational process within the economic courses not only in higher education institutions but also in secondary education institutions of Ukraine.

This article highlights further research by the authors, begun in [59, 60, 61, 62, 63, 64, 65, 66, 67, 68, 69, 70, 71, 72, 73, 74, 75, 76, 77, 78, 79, 80, 81, 82, 83, 84, 85, 86, 87, 88, 89, 90, 91, 92, 93, 94, 95, 96, 97, 98].

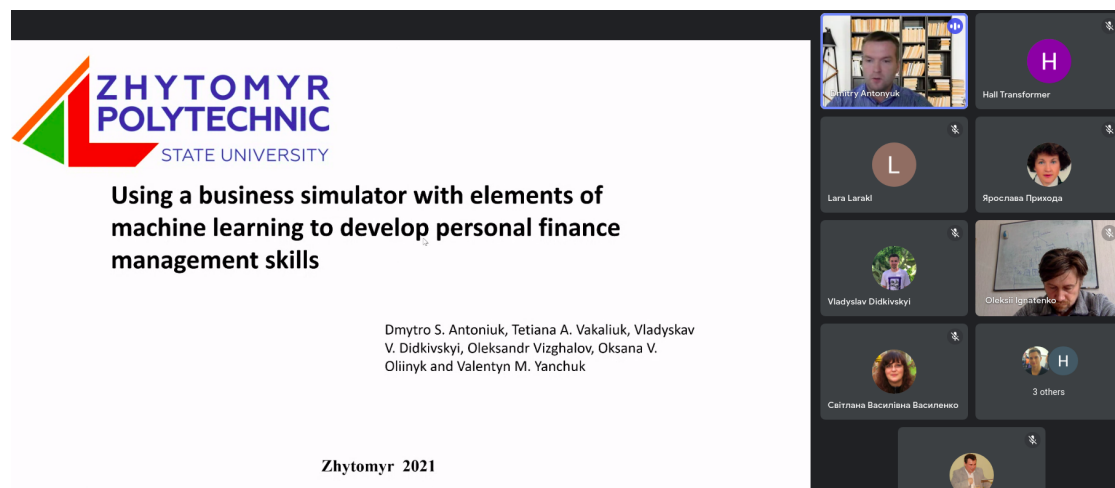

Figure 6: Presentation of paper [4].

The article “Modeling of the internal certification system of educational resources view or update” [6] by Oksana P. Buinytska and Svitlana V. Vasylenko (figure 7) analyzes the research, which was carried out for several years to model the system of internal certification of educational resources for blended and e-learning in Higher education. The authors describe the prerequisites for the internal certification system modeling and the features of recent changes in the process of internal certification of educational resources, approved by the university regulations, which is related to the requirements of the situation with COVID-19. The article describes the current model of the system of internal certification of educational resources, which is based on the approbation of the pilot model of e-learning courses (hereinafter – ELC) certification. The key components of the internal certification system are three mandatory expertise (professional, resource and technical). Based on the results of which, the methodological commission decides

on the quality of educational resources of the ENC and its certification. Expectations from the current system of internal certification of ELC implementation were justified to a high degree, in particular, we have the following advantages of their use: the creation of quality educational resources, expanding access to various categories of participants in the educational process to educational content; ensuring the individualization of the educational process under the needs, characteristics and capabilities of learners; improving the quality and efficiency of the educational process through the use of digital and innovative educational technologies; ensuring systematic monitoring of the quality of education, implementation of blended and e-learning in higher education.



Figure 7: Presentation of paper [6].

Behavioral game theory typically investigate difference between game-theoretic solution and real behavior, one can observe from experiments. The research question, formulated by Oleksii P. Ignatenko (figure 8) in the article “Strategic learning towards equilibrium. Exploratory analysis and models” [12], is how players learn in complex strategic situations which they never faced before. We examine data from different games, played during lectures about game theory and present findings about players progress in strategic learning while competing with other players. We proposed four “pick a number” games, all with similar-looking rules but very different properties. These games were introduced (in the body of scientific popular lectures) to very different groups of listeners. We model and analyse data from the experiments to explain different models of thinking, agent can apply in the games. All data gathered are available in open repository for replication and analysis. Finally, we discuss the findings propose hypothesis to investigate and formulate open questions for future research.

This article highlights further research by the author, begun in [99, 100].

Nowadays computer modeling and simulation widely use in computer science education. There are several ways of increasing the efficiency of educational process. One of the such ways is visualization, other way is flipped classroom concept. The aim of the article “Some ways of increasing the efficiency of teaching data structures” [11] by Zarema S. Seidametova (figure 9)

The image shows a presentation slide with two main sections. The top section is titled "Game as a mathematical object" and lists three bullet points: "Set of players", "Set of strategies", and "Payoffs". The background of this section is a chalkboard filled with mathematical formulas and diagrams, including $\lim_{n \rightarrow \infty} \frac{1n^{2+1} + n}{3n^2 + 2n - 1}$, $\frac{a}{\sin \alpha} = \frac{b}{\sin \beta} = \frac{c}{\sin \gamma}$, $y = \sqrt[3]{x+1}$, $x = \tan t$, $C = (0, 1)$, $(1, 0)$, $f(x) = 2^{-x} + 1, \epsilon = 0.005$, $\lambda_2 = 1 \sqrt{14}$, and $y = \cos 9x$. The bottom section is titled "Rules of 3" and lists three rules: "1. Choose integer from 1 to 100", "2. The number that is the choice of max amount of players - wins.", and "3. If two numbers has the same amount of choices - **smaller** wins." To the left of the "Rules of 3" text is an image of several dice with numbers on them. On the right side of the slide, there is a video conference interface showing several participants in a grid layout, including "Oleksii Ignatenko", "Hall Transformer", "Світлана Василівна Василенко", "Dmitry Antonyuk", "Igor Pally", "Zarema Seldametova", "Lara Laraki", and "3 others".

Figure 8: Presentation of paper [12].

is to present some ways of increasing the efficiency of teaching data structures (hashing, trees) during Algorithms and data structures course. Author conducted two experiments with four study groups of two subjects of the Algorithms and Data Structures – (1) Hashing, (2) Trees (BST, RBT, AVL), – taught second year bachelor students. In the first experiment study groups were prepared on the subjects (1) and (2) by the same level of teaching technique with or without visualization tools. Unlike the first experiment, in the second experiment we used flipped classroom concept for one study group and a standard way of teaching for another group.

This article highlights further research by the author, begun in [101, 102, 103, 104, 105].

Currently, augmented reality is one of the most actively developing technologies, which has also found its application in the field of education. Analysis of various publications has confirmed that AR technology opens up new opportunities for teachers and increases the attractiveness of learning for students of different ages. mobile AR apps allow the student to see a real-world environment with overlaid or composite virtual objects. This is especially true for young children.

Algorithms and Data Structures learning roadmap: part 1

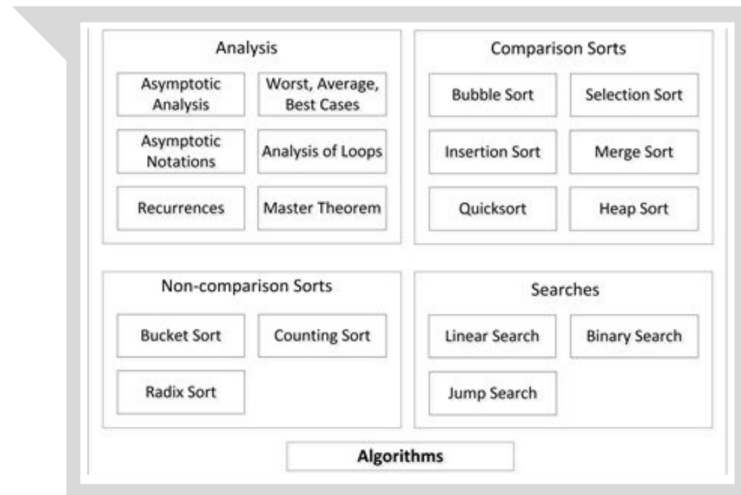

Figure 9: Presentation of paper [11].

The article “Using augmented reality for early literacy” [9] by Olena Ie. Piatykop (figure 10), and Olha I. Pronina, Iryna B. Tymofieieva and Ihor D. Palii identifies the activities that provide a child’s personal experience using AR technology. Comparison of existing AR applications for learning the alphabet is given. A new AR application is described, which was developed using Unity, C#, Vuforia. The developed mobile AR application provides an opportunity to study the Ukrainian alphabet, the names of numbers, the sounds of animals. Thanks to this application, the learning process is accompanied by three-dimensional visualization and sounding of each letter and number. An analysis of a survey of teachers and parents showed that when using an AR application, the interest and self-efficacy of children in learning letters and numbers significantly increased. The use of the AR application increased the speed of memorizing the material and helped to retain the child’s attention while learning a new material.

This article highlights further research by the authors, begun in [106].

4. CoSinE 2021: Conclusion

CoSinE 2021 workshop at ICTERI 2021 would not have been possible without the support of many people. We would like to thank all the authors who submitted papers to our workshop and thus demonstrated their interest in the research problems within our scope (figure 11). We are also very grateful to the members of our Program Committees for providing timely and thorough reviews and being cooperative in doing additional review work. We would like to thank the local organizers of the conference, the steering committee, and the technical support team for their valuable service and help. Special thanks go to the sponsors of ICTERI 2021 whose financial and technical contributions enabled the materialization of this instance of the conference and its sub-events. All these people, their devotion, energy, and efficiency, made our workshop a very interesting and effective scientific forum.



Figure 10: Presentation of paper [9].

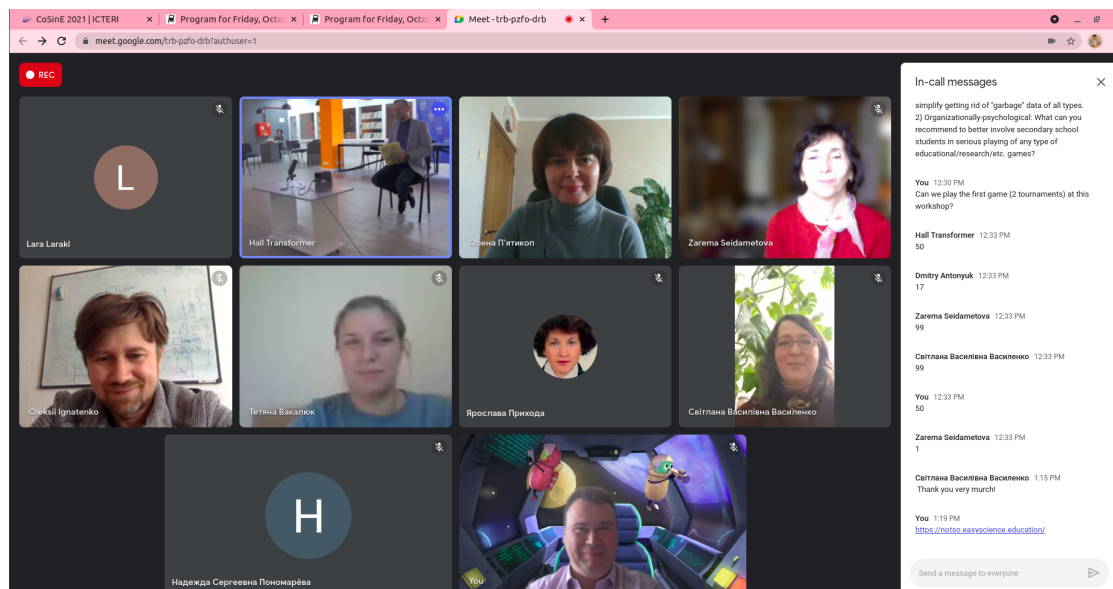

Figure 11: Blended workshop in pandemic times.

References

- [1] V. Ermolayev, F. Mallet, V. Yakovyna, V. Kharchenko, V. Kobets, A. Kornilowicz, H. Kravtsov, M. Nikitchenko, S. Semerikov, A. Spivakovskiy, Preface, CEUR Workshop Proceedings 2393 (2019). URL: <http://ceur-ws.org/Vol-2393/preface.pdf>.
- [2] O. Sokolov, G. Zholtkevych, V. Yakovyna, Y. Tarasich, V. Kharchenko, V. Kobets, O. Burov,

- S. Semerikov, H. Kravtsov, Preface, CEUR Workshop Proceedings 2732 (2020). URL: <http://ceur-ws.org/Vol-2732/preface.pdf>.
- [3] V. A. Ermolayev, A. E. Kiv, S. O. Semerikov, V. N. Soloviev, A. M. Striuk, 9th illia o. teplytskyi workshop on computer simulation in education, CEUR Workshop Proceedings (2022).
- [4] D. S. Antoniuk, T. A. Vakaliuk, V. V. Didkivskiy, O. Y. Vizghalov, O. V. Oliinyk, V. M. Yanchuk, Using a business simulator with elements of machine learning to develop personal finance management skills, CEUR Workshop Proceedings (2022).
- [5] A. A. Kostikov, K. V. Vlasenko, I. V. Lovianova, S. V. Volkov, E. O. Avramov, The algorithm for knowledge assessment based on the Rusch model, CEUR Workshop Proceedings (2022).
- [6] O. P. Buinytska, S. V. Vasylenko, Modeling of the internal certification system of educational resources view or update, CEUR Workshop Proceedings (2022).
- [7] L. I. Bilousova, L. E. Gryzun, A Petri net-based simulation of synchronized curriculum for IT-specialists' training, CEUR Workshop Proceedings (2022).
- [8] R. A. Tarasenko, S. A. Usenko, Y. B. Shapovalov, V. B. Shapovalov, A. Paschke, I. M. Savchenko, Ontology-based learning environment model of scientific studies, CEUR Workshop Proceedings (2022).
- [9] O. I. Piatykop, O. I. Pronina, I. B. Tymofieieva, I. D. Palii, Using augmented reality for early literacy, CEUR Workshop Proceedings (2022).
- [10] O. H. Kolgatin, L. S. Kolgatina, N. S. Ponomareva, Computational modelling of stochastic processes for learning research, CEUR Workshop Proceedings (2022).
- [11] Z. S. Seidametova, Some ways of increasing the efficiency of teaching data structures, CEUR Workshop Proceedings (2022).
- [12] O. P. Ignatenko, Strategic learning towards equilibrium. Exploratory analysis and models, CEUR Workshop Proceedings (2022).
- [13] L. I. Bilousova, O. H. Kolgatin, L. S. Kolgatina, O. H. Kuzminska, Introspection as a condition of students' self-management in programming training, in: S. Semerikov, V. Osadchy, O. Kuzminska (Eds.), Proceedings of the Symposium on Advances in Educational Technology, AET 2020, University of Educational Management, SciTePress, Kyiv, 2022.
- [14] O. H. Kolgatin, L. S. Kolgatina, N. S. Ponomareva, E. O. Shmeltser, A. D. Uchitel, Systematicity of students' independent work in cloud learning environment of the course "Educational Electronic Resources for Primary School" for the future teachers of primary schools, in: S. Semerikov, V. Osadchy, O. Kuzminska (Eds.), Proceedings of the Symposium on Advances in Educational Technology, AET 2020, University of Educational Management, SciTePress, Kyiv, 2022.
- [15] S. H. Lytvynova, S. O. Semerikov, A. M. Striuk, M. I. Striuk, L. S. Kolgatina, V. Y. Velychko, I. S. Mintii, O. O. Kalinichenko, AREdu 2021 – Immersive technology today, CEUR Workshop Proceedings 2898 (2021) 1–40. URL: <http://ceur-ws.org/Vol-2898/paper00.pdf>.
- [16] S. O. Semerikov, M. P. Shyshkina, A. M. Striuk, M. I. Striuk, I. S. Mintii, O. O. Kalinichenko, L. S. Kolgatina, M. Y. Karpova, 8th Workshop on Cloud Technologies in Education: Report, CEUR Workshop Proceedings 2879 (2020) 1–69.
- [17] O. Y. Burov, A. E. Kiv, S. O. Semerikov, A. M. Striuk, M. I. Striuk, L. S. Kolgatina, I. V. Oliinyk, AREdu 2020 - How augmented reality helps during the coronavirus pandemic, CEUR

- Workshop Proceedings 2731 (2020) 1–46. URL: <http://ceur-ws.org/Vol-2731/paper00.pdf>.
- [18] S. O. Semerikov, I. O. Teplytskyi, V. N. Soloviev, V. A. Hamaniuk, N. S. Ponomareva, O. H. Kolgatin, L. S. Kolgatina, T. V. Byelyavtseva, S. M. Amelina, R. O. Tarasenko, Methodic quest: Reinventing the system, *Journal of Physics: Conference Series* 1840 (2021) 012036. doi:10.1088/1742-6596/1840/1/012036.
- [19] L. Bilousova, O. Kolgatin, L. Kolgatina, Computer simulation as a method of learning research in computational mathematics, *CEUR Workshop Proceedings* 2393 (2019) 880–894.
- [20] O. H. Kolgatin, L. S. Kolgatina, N. S. Ponomareva, E. O. Shmeltser, Systematicity of students' independent work in cloud learning environment, *CEUR Workshop Proceedings* 2433 (2019) 184–196.
- [21] N. S. Ponomareva, Role and place of informatics in the training of future teachers of mathematics, *Journal of Physics: Conference Series* 1840 (2021) 012035. doi:10.1088/1742-6596/1840/1/012035.
- [22] L. Bilousova, I. L. E. Gryzun, N. V. Zhytienova, Fundamentals of UI/UX design as a component of the pre-service specialist's curriculum, *SHS Web of Conferences* 104 (2021) 02015. doi:10.1051/shsconf/202110402015.
- [23] L. I. Bilousova, L. E. Gryzun, S. H. Lytvynova, V. V. Pikalova, Modelling in GeoGebra in the context of holistic approach realization in mathematical training of pre-service specialists, in: S. Semerikov, V. Osadchyi, O. Kuzminska (Eds.), *Proceedings of the Symposium on Advances in Educational Technology, AET 2020, University of Educational Management, SciTePress, Kyiv, 2022*.
- [24] L. I. Bilousova, L. E. Gryzun, N. P. Volkova, Features of design of digital aids for training students with autistic disorders, *CEUR Workshop Proceedings* 2879 (2020) 221–232.
- [25] N. V. Olefirenko, I. I. Kostikova, N. O. Ponomarova, L. I. Bilousova, A. V. Pikilnyak, E-learning resources for successful math teaching to pupils of primary school, *CEUR Workshop Proceedings* 2433 (2019) 443–458.
- [26] L. I. Bilousova, L. E. Gryzun, D. H. Sherstiuk, E. O. Shmeltser, Cloud-based complex of computer transdisciplinary models in the context of holistic educational approach, *CEUR Workshop Proceedings* 2433 (2019) 336–351.
- [27] L. I. Bilousova, L. E. Gryzun, J. O. Rakusa, E. O. Shmeltser, Informatics teacher's training for design of innovative learning aids, *CEUR Workshop Proceedings* 2643 (2020) 563–577.
- [28] L. Bilousova, L. Gryzun, I. Sivochka, Petri nets android application as a mobile aid for students' mastering modelling, *Journal of Physics: Conference Series* 1840 (2021) 012033. doi:10.1088/1742-6596/1840/1/012033.
- [29] K. V. Vlasenko, S. V. Volkov, I. V. Lovianova, I. V. Sitak, O. O. Chumak, S. O. Semerikov, N. H. Bohdanova, The criteria of usability design for educational online courses, in: S. Semerikov, V. Osadchyi, O. Kuzminska (Eds.), *Proceedings of the Symposium on Advances in Educational Technology, AET 2020, University of Educational Management, SciTePress, Kyiv, 2022*.
- [30] K. V. Vlasenko, I. V. Sitak, D. A. Kovalenko, S. V. Volkov, I. V. Lovianova, S. O. Semerikov, S. L. Zahrebelnyi, Methodical recommendations for the development of online course structure and content, in: S. Semerikov, V. Osadchyi, O. Kuzminska (Eds.), *Proceedings of the Symposium on Advances in Educational Technology, AET 2020, University of*

Educational Management, SciTePress, Kyiv, 2022.

- [31] K. V. Vlasenko, O. H. Rovenska, I. V. Lovianova, O. M. Kondratyeva, V. V. Achkan, Y. M. Tkachenko, M. P. Shyshkina, The implementation of inquiry-based learning in the organization of students' research activities on Mathematics, in: S. Semerikov, V. Osadchyi, O. Kuzminska (Eds.), Proceedings of the Symposium on Advances in Educational Technology, AET 2020, University of Educational Management, SciTePress, Kyiv, 2022.
- [32] V. V. Achkan, K. V. Vlasenko, I. V. Lovianova, O. H. Rovenska, I. V. Sitak, O. O. Chumak, S. O. Semerikov, Web-based support of a higher school teacher, in: S. Semerikov, V. Osadchyi, O. Kuzminska (Eds.), Proceedings of the Symposium on Advances in Educational Technology, AET 2020, University of Educational Management, SciTePress, Kyiv, 2022.
- [33] K. V. Vlasenko, S. V. Volkov, I. V. Lovianova, O. O. Chumak, I. V. Sitak, D. Y. Bobyliev, Management of online platform development and support process, CEUR Workshop Proceedings 2879 (2020) 333–345.
- [34] K. V. Vlasenko, O. G. Rovenska, O. O. Chumak, I. V. Lovianova, V. V. Achkan, A Comprehensive Program of activities to develop sustainable core skills in novice scientists, Journal of Physics: Conference Series 1946 (2021) 012017. doi:10.1088/1742-6596/1946/1/012017.
- [35] K. V. Vlasenko, I. V. Lovianova, O. G. Rovenska, T. S. Armash, V. V. Achkan, Development of the online course for training master students majoring in mathematics, Journal of Physics: Conference Series 1946 (2021) 012001. doi:10.1088/1742-6596/1946/1/012001.
- [36] K. V. Vlasenko, I. V. Lovianova, T. S. Armash, I. V. Sitak, D. A. Kovalenko, A competency-based approach to the systematization of mathematical problems in a specialized school, Journal of Physics: Conference Series 1946 (2021) 012003. doi:10.1088/1742-6596/1946/1/012003.
- [37] K. V. Vlasenko, S. V. Volkov, D. A. Kovalenko, I. V. Sitak, O. O. Chumak, A. A. Kostikov, Web-based online course training higher school mathematics teachers, CEUR Workshop Proceedings 2643 (2020) 648–661.
- [38] L. F. Panchenko, T. A. Vakaliuk, K. V. Vlasenko, Augmented reality books: Concepts, typology, tools, CEUR Workshop Proceedings 2731 (2020) 283–296.
- [39] K. Vlasenko, O. Kondratyeva, I. Khyzhniak, O. Chumak, S. Volkov, Developing training materials for the on-line course “Project method in teaching higher mathematics”, CEUR Workshop Proceedings 2732 (2020) 756–769.
- [40] K. Vlasenko, D. Kovalenko, O. Chumak, I. Lovianova, S. Volkov, Minimalism in designing user interface of the online platform “Higher school mathematics teacher”, CEUR Workshop Proceedings 2732 (2020) 1028–1043.
- [41] K. Vlasenko, S. Volkov, I. Sitak, I. Lovianova, D. Bobyliev, Usability analysis of on-line educational courses on the platform “Higher school mathematics teacher”, E3S Web of Conferences 166 (2020) 10012. doi:10.1051/e3sconf/202016610012.
- [42] K. Vlasenko, O. Chumak, I. Lovianova, D. Kovalenko, N. Volkova, Methodical requirements for training materials of on-line courses on the platform “Higher school mathematics teacher”, E3S Web of Conferences 166 (2020) 10011. doi:10.1051/e3sconf/202016610011.
- [43] K. V. Vlasenko, I. V. Lovianova, O. O. Chumak, I. V. Sitak, V. V. Achkan, The arrangement of on-line training of master students, majoring in Mathematics for internship in technical

- universities, *Journal of Physics: Conference Series* 1840 (2021) 012007. doi:10.1088/1742-6596/1840/1/012007.
- [44] K. V. Vlasenko, O. O. Chumak, I. V. Sitak, V. V. Achkan, O. M. Kondratyeva, Methods for developing motivational and value-orientated readiness of math students at teacher training universities for implementing educational innovations, *Journal of Physics: Conference Series* 1840 (2021) 012008. doi:10.1088/1742-6596/1840/1/012008.
- [45] I. V. Lovianova, D. Y. Bobyliev, A. D. Uchitel, Cloud calculations within the optional course Optimization Problems for 10th-11th graders, *CEUR Workshop Proceedings* 2433 (2019) 459–471.
- [46] S. V. Shokaliuk, Y. Y. Bohunencko, I. V. Lovianova, M. P. Shyshkina, Technologies of distance learning for programming basics on the principles of integrated development of key competences, *CEUR Workshop Proceedings* 2643 (2020) 548–562.
- [47] Y. Shapovalov, V. Shapovalov, A taxonomic representation of scientific studies, *CEUR Workshop Proceedings* 3013 (2021) 353–360.
- [48] Z. I. Bilyk, Y. B. Shapovalov, V. B. Shapovalov, A. P. Megalinska, S. O. Zhadan, F. Andruskiewicz, A. Dołhańczuk-Śródka, P. D. Antonenko, Comparing Google Lens recognition accuracy with other plant recognition apps, in: S. Semerikov, V. Osadchyi, O. Kuzminska (Eds.), *Proceedings of the Symposium on Advances in Educational Technology, AET 2020, University of Educational Management, SciTePress, Kyiv, 2022*.
- [49] Y. B. Shapovalov, Z. I. Bilyk, S. A. Usenko, V. B. Shapovalov, K. H. Postova, S. O. Zhadan, P. D. Antonenko, Using of personal smart tools in STEM education, in: S. Semerikov, V. Osadchyi, O. Kuzminska (Eds.), *Proceedings of the Symposium on Advances in Educational Technology, AET 2020, University of Educational Management, SciTePress, Kyiv, 2022*.
- [50] R. A. Tarasenko, V. B. Shapovalov, S. A. Usenko, Y. B. Shapovalov, I. M. Savchenko, Y. Y. Pashchenko, A. Paschke, Comparison of ontology with non-ontology tools for educational research, *CEUR Workshop Proceedings* 2879 (2020) 82–104.
- [51] Y. B. Shapovalov, V. B. Shapovalov, R. A. Tarasenko, S. A. Usenko, A. Paschke, A semantic structuring of educational research using ontologies, *CEUR Workshop Proceedings* 2879 (2020) 105–123.
- [52] Y. B. Shapovalov, Z. I. Bilyk, A. I. Atamas, V. B. Shapovalov, A. D. Uchitel, The potential of using Google Expeditions and Google Lens tools under STEM-education in Ukraine, *CEUR Workshop Proceedings* 2257 (2018) 66–74.
- [53] V. B. Shapovalov, A. I. Atamas, Z. I. Bilyk, Y. B. Shapovalov, A. D. Uchitel, Structuring augmented reality information on the stemua.science, *CEUR Workshop Proceedings* 2257 (2018) 75–86.
- [54] V. B. Shapovalov, Y. B. Shapovalov, Z. I. Bilyk, A. I. Atamas, R. A. Tarasenko, V. V. Tron, Centralized information web-oriented educational environment of Ukraine, *CEUR Workshop Proceedings* 2433 (2019) 246–255.
- [55] Y. B. Shapovalov, V. B. Shapovalov, V. I. Zaselskiy, TODOS as digital science-support environment to provide STEM-education, *CEUR Workshop Proceedings* 2433 (2019) 232–245.
- [56] V. B. Shapovalov, Y. B. Shapovalov, Z. I. Bilyk, A. P. Megalinska, I. O. Muzyka, The Google Lens analyzing quality: An analysis of the possibility to use in the educational process,

- CEUR Workshop Proceedings 2547 (2020) 117–129.
- [57] Y. B. Shapovalov, V. B. Shapovalov, F. Andruszkiewicz, N. P. Volkova, Analyzing of main trends of STEM education in Ukraine using stemua.science statistics, CEUR Workshop Proceedings 2643 (2020) 448–461.
- [58] Z. I. Bilyk, Y. B. Shapovalov, V. B. Shapovalov, A. P. Megalinska, F. Andruszkiewicz, A. Dołhańczuk-Śródka, Assessment of mobile phone applications feasibility on plant recognition: Comparison with Google Lens AR-app, CEUR Workshop Proceedings 2731 (2020) 61–78.
- [59] V. M. Yanchuk, D. S. Antoniuk, A. G. Tkachuk, E. Maestri, O. Vizghalov, Integration of delivery services business cases for improvement of business and environmental sustainability of e-commerce solutions, CEUR Workshop Proceedings 2732 (2020) 363–376.
- [60] A. Humeniuk, O. Bezvesilna, M. Bogdanovskyi, V. Yanchuk, Information and measurement system for determining the acceleration of gravity based on a ballistic gravimeter with a two-dimensional video system, E3S Web of Conferences 166 (2020) 05006. doi:10.1051/e3sconf/202016605006.
- [61] D. S. Antoniuk, T. A. Vakaliuk, V. V. Didkivskyi, O. Y. Vizghalov, Development of a simulator to determine personal financial strategies using machine learning, CEUR Workshop Proceedings 3077 (2022) 12–26. URL: <http://ceur-ws.org/Vol-3077/paper02.pdf>.
- [62] N. I. Cheboksarova, T. A. Vakaliuk, I. M. Iefremov, Development of CRM system with a mobile application for a school, CEUR Workshop Proceedings 3077 (2022) 44–65. URL: <http://ceur-ws.org/Vol-3077/paper09.pdf>.
- [63] T. Vakaliuk, I. Novitska, I. Verbovsky, T. Rozhnova, V. Kontsedailo, Management of educational institutions with inclusive education based on innovative technologies, SHS Web of Conferences 104 (2021) 03008. doi:10.1051/shsconf/202110403008.
- [64] T. A. Vakaliuk, O. D. Gavryliuk, V. V. Kontsedailo, V. P. Oleksiuk, O. O. Kalinichenko, Selection cloud-oriented learning technologies for the formation of professional competencies of bachelors majoring in statistics and general methodology of their use, in: S. Semerikov, V. Osadchyi, O. Kuzminska (Eds.), Proceedings of the Symposium on Advances in Educational Technology, AET 2020, University of Educational Management, SciTePress, Kyiv, 2022.
- [65] V. P. Oleksiuk, O. R. Oleksiuk, T. A. Vakaliuk, An experiment on the implementation the methodology of teaching cloud technologies to future Computer Science teachers, in: S. Semerikov, V. Osadchyi, O. Kuzminska (Eds.), Proceedings of the Symposium on Advances in Educational Technology, AET 2020, University of Educational Management, SciTePress, Kyiv, 2022.
- [66] T. A. Vakaliuk, V. V. Kontsedailo, D. S. Antoniuk, O. V. Korotun, S. O. Semerikov, I. S. Mintii, O. O. Kalinichenko, Possibilities of using the game simulator Software Inc in the training of future software engineers, in: S. Semerikov, V. Osadchyi, O. Kuzminska (Eds.), Proceedings of the Symposium on Advances in Educational Technology, AET 2020, University of Educational Management, SciTePress, Kyiv, 2022.
- [67] T. A. Vakaliuk, D. S. Antoniuk, O. O. Kalinichenko, The state of ICT implementation in Ukrainian general secondary education institutions in 2019 and 2020, in: S. Semerikov, V. Osadchyi, O. Kuzminska (Eds.), Proceedings of the Symposium on Advances in Educa-

- tional Technology, AET 2020, University of Educational Management, SciTePress, Kyiv, 2022.
- [68] T. A. Vakaliuk, O. A. Chernysh, V. O. Babenko, The algorithm of electronic multilingual terminological dictionary compilation, in: S. Semerikov, V. Osadchyi, O. Kuzminska (Eds.), Proceedings of the Symposium on Advances in Educational Technology, AET 2020, University of Educational Management, SciTePress, Kyiv, 2022.
- [69] T. A. Vakaliuk, S. I. Pochtoviuk, Analysis of tools for the development of augmented reality technologies, CEUR Workshop Proceedings 2898 (2021) 119–130. URL: <http://ceur-ws.org/Vol-2898/paper06.pdf>.
- [70] O. V. Zaika, T. A. Vakaliuk, A. V. Riabko, R. P. Kukharchuk, I. S. Mintii, S. O. Semerikov, Selection of online tools for creating math tests, CEUR Workshop Proceedings 2898 (2021) 82–106. URL: <http://ceur-ws.org/Vol-2898/paper04.pdf>.
- [71] I. S. Mintii, T. A. Vakaliuk, S. M. Ivanova, O. A. Chernysh, S. M. Hryshchenko, S. O. Semerikov, Current state and prospects of distance learning development in Ukraine, CEUR Workshop Proceedings 2898 (2021) 41–55. URL: <http://ceur-ws.org/Vol-2898/paper01.pdf>.
- [72] T. A. Vakaliuk, O. V. Korotun, S. O. Semerikov, The selection of cloud services for ER-diagrams construction in IT specialists databases teaching, CEUR Workshop Proceedings 2879 (2020) 384–397.
- [73] A. E. Kiv, V. N. Soloviev, S. O. Semerikov, A. M. Striuk, V. V. Osadchyi, T. A. Vakaliuk, P. P. Nechypurenko, O. V. Bondarenko, I. S. Mintii, S. L. Malchenko, XIII International Conference on Mathematics, Science and Technology Education, Journal of Physics: Conference Series 1946 (2021) 011001. URL: <https://doi.org/10.1088/1742-6596/1946/1/011001>. doi:10.1088/1742-6596/1946/1/011001.
- [74] D. S. Antoniuk, T. A. Vakaliuk, V. V. Ievdokymov, A. V. Morozov, V. V. Kontsedailo, Integrating business simulations software into learning environment of technical university, Journal of Physics: Conference Series 1946 (2021) 012018. doi:10.1088/1742-6596/1946/1/012018.
- [75] L. A. Martseva, L. H. Movchan, T. A. Vakaliuk, D. S. Antoniuk, Applying CDIO-approach at technical universities, Journal of Physics: Conference Series 1946 (2021) 012013. doi:10.1088/1742-6596/1946/1/012013.
- [76] I. P. Varava, A. P. Bohinska, T. A. Vakaliuk, I. S. Mintii, Soft skills in software engineering technicians education, Journal of Physics: Conference Series 1946 (2021) 012012. doi:10.1088/1742-6596/1946/1/012012.
- [77] T. Vakaliuk, V. Kontsedailo, D. Antoniuk, O. Korotun, S. Semerikov, I. Mintii, Using Game Dev Tycoon to develop professional soft competencies for future engineers-programmers, CEUR Workshop Proceedings 2732 (2020) 808–822. URL: <http://ceur-ws.org/Vol-2732/20200808.pdf>.
- [78] S. Semerikov, S. Chukharev, S. Sakhno, A. Striuk, V. Osadchyi, V. Solovieva, T. Vakaliuk, P. Nechypurenko, O. Bondarenko, H. Danylchuk, Our sustainable coronavirus future, E3S Web of Conferences 166 (2020) 00001. URL: https://www.e3s-conferences.org/articles/e3sconf/abs/2020/26/e3sconf_icsf2020_00001/e3sconf_icsf2020_00001.html. doi:10.1051/e3sconf/202016600001.
- [79] D. S. Shepiliiev, S. O. Semerikov, Y. V. Yechkalo, V. V. Tkachuk, O. M. Markova, Y. O. Modlo, I. S. Mintii, M. M. Mintii, T. V. Selivanova, N. K. Maksyshko, T. A. Vakaliuk,

- V. V. Osadchyi, R. O. Tarasenko, S. M. Amelina, A. E. Kiv, Development of career guidance quests using WebAR, *Journal of Physics: Conference Series* 1840 (2021) 012028. doi:10.1088/1742-6596/1840/1/012028.
- [80] O. V. Korotun, T. A. Vakaliuk, V. A. Oleshko, Development of a web-based system of automatic content retrieval database, *CEUR Workshop Proceedings* 2546 (2019) 182–197.
- [81] I. S. Mintii, S. V. Shokaliuk, T. A. Vakaliuk, M. M. Mintii, V. N. Soloviev, Import test questions into Moodle LMS, *CEUR Workshop Proceedings* 2433 (2019) 529–540.
- [82] S. I. Pochtoviuk, T. A. Vakaliuk, A. V. Pikilnyak, Possibilities of application of augmented reality in different branches of education, *CEUR Workshop Proceedings* 2547 (2020) 92–106.
- [83] T. A. Vakaliuk, V. V. Kontsedailo, D. S. Antoniuk, O. V. Korotun, I. S. Mintii, A. V. Pikilnyak, Using game simulator Software Inc in the Software Engineering education, *CEUR Workshop Proceedings* 2547 (2020) 66–80.
- [84] T. A. Vakaliuk, D. S. Antoniuk, V. N. Soloviev, The state of ICT implementation in institutions of general secondary education: A case of Ukraine, *CEUR Workshop Proceedings* 2643 (2020) 119–133.
- [85] O. V. Korotun, T. A. Vakaliuk, V. N. Soloviev, Model of using cloud-based environment in training databases of future IT specialists, *CEUR Workshop Proceedings* 2643 (2020) 281–292. URL: <http://ceur-ws.org/Vol-2643/paper16.pdf>.
- [86] V. V. Hordiienko, G. V. Marchuk, T. A. Vakaliuk, A. V. Pikilnyak, Development of a model of the solar system in AR and 3D, *CEUR Workshop Proceedings* 2731 (2020) 217–238.
- [87] T. A. Vakaliuk, A. A. Yefimenko, V. V. Bolotina, Y. M. Bailiuk, O. A. Pokotylo, S. Didkivska, Using massive open online courses in teaching the subject “Computer networks” to the future IT specialists, *CEUR Workshop Proceedings* 2732 (2020) 665–676.
- [88] S. I. Pochtovyuk, V. P. Chernenko, T. A. Vakaliuk, Information and communication technologies in the study of mathematical methods in psychology, *CEUR Workshop Proceedings* 2732 (2020) 1249–1259.
- [89] O. Uvayeva, T. Vakaliuk, D. Kostromin, Environmental monitoring and recommendations on decreasing the levels of pesticide pollution in Zhytomyr region of Ukraine, *E3S Web of Conferences* 166 (2020) 01004. doi:10.1051/e3sconf/202016601004.
- [90] T. Vakaliuk, D. Antoniuk, A. Morozov, M. Medvedieva, M. Medvediev, Green IT as a tool for design cloud-oriented sustainable learning environment of a higher education institution, *E3S Web of Conferences* 166 (2020) 10013. doi:10.1051/e3sconf/202016610013.
- [91] V. P. Chernenko, S. I. Pochtovyuk, T. A. Vakaliuk, L. D. Shevchuk, Y. V. Slon, Information system of economic and mathematical modelling of pricing in the residential sector of Ukraine, *Journal of Physics: Conference Series* 1840 (2021) 012025. URL: <https://doi.org/10.1088/1742-6596/1840/1/012025>. doi:10.1088/1742-6596/1840/1/012025.
- [92] T. A. Vakaliuk, O. M. Spirin, N. M. Lobanchykova, L. A. Martseva, I. V. Novitska, V. V. Kontsedailo, Features of distance learning of cloud technologies for the organization educational process in quarantine, *Journal of Physics: Conference Series* 1840 (2021) 012051. doi:10.1088/1742-6596/1840/1/012051.
- [93] A. V. Morozov, T. A. Vakaliuk, An electronic environment of higher education institution (on the example of Zhytomyr Polytechnic State University), *Journal of Physics: Conference Series* 1840 (2021) 012061. URL: <https://doi.org/10.1088/1742-6596/1840/1/012061>.

doi:10.1088/1742-6596/1840/1/012061.

- [94] D. S. Shepiliiev, Y. O. Modlo, Y. V. Yechkalo, V. V. Tkachuk, M. M. Mintii, I. S. Mintii, O. M. Markova, T. V. Selivanova, O. M. Drashko, O. O. Kalinichenko, T. A. Vakaliuk, V. V. Osadchyi, S. O. Semerikov, WebAR development tools: An overview, CEUR Workshop Proceedings 2832 (2020) 84–93. URL: <http://ceur-ws.org/Vol-2832/paper12.pdf>.
- [95] S. O. Semerikov, A. M. Striuk, T. A. Vakaliuk, A. V. Morozov, Quantum information technology on the Edge, CEUR Workshop Proceedings 2850 (2021) 1–15. URL: <http://ceur-ws.org/Vol-2850/paper0.pdf>.
- [96] A. V. Ryabko, O. V. Zaika, R. P. Kukharchuk, T. A. Vakaliuk, Graph model of Fog Computing system, CEUR Workshop Proceedings 2850 (2021) 28–44. URL: <http://ceur-ws.org/Vol-2850/paper2.pdf>.
- [97] T. M. Nikitchuk, T. A. Vakaliuk, O. A. Chernysh, O. L. Korenivska, L. A. Martseva, V. V. Osadchyi, Architecture for edge devices for diagnostics of students' physical condition, CEUR Workshop Proceedings 2850 (2021) 45–56. URL: <http://ceur-ws.org/Vol-2850/paper3.pdf>.
- [98] I. Pilkevych, O. Boychenko, N. Lobanchykova, T. Vakaliuk, S. Semerikov, Method of assessing the influence of personnel competence on institutional information security, CEUR Workshop Proceedings 2853 (2021) 266–275. URL: <http://ceur-ws.org/Vol-2853/paper33.pdf>.
- [99] O. P. Ignatenko, Guessing games experiments in Ukraine. Learning towards equilibrium, in: S. Semerikov, V. Osadchyi, O. Kuzminska (Eds.), Proceedings of the Symposium on Advances in Educational Technology, AET 2020, University of Educational Management, SciTePress, Kyiv, 2022.
- [100] O. Ignatenko, Guessing games experiments in school education and their analysis, CEUR Workshop Proceedings 2732 (2020) 881–892.
- [101] Z. S. Seidametova, MOOCs types and course development, in: S. Semerikov, V. Osadchyi, O. Kuzminska (Eds.), Proceedings of the Symposium on Advances in Educational Technology, AET 2020, University of Educational Management, SciTePress, Kyiv, 2022.
- [102] Z. S. Seidametova, V. A. Temnenko, Some geometric objects related to a family of the ballistic trajectories in a viscous medium, in: S. Semerikov, V. Osadchyi, O. Kuzminska (Eds.), Proceedings of the Symposium on Advances in Educational Technology, AET 2020, University of Educational Management, SciTePress, Kyiv, 2022.
- [103] Z. S. Seidametova, V. A. Temnenko, An inverse method of the natural setting for integer, half-integer and rational “perfect” hypocycloids, in: S. Semerikov, V. Osadchyi, O. Kuzminska (Eds.), Proceedings of the Symposium on Advances in Educational Technology, AET 2020, University of Educational Management, SciTePress, Kyiv, 2022.
- [104] Z. S. Seidametova, Z. S. Abduramanov, G. S. Seydametov, Using augmented reality for architecture artifacts visualizations, CEUR Workshop Proceedings 2898 (2021) 131–146. URL: <http://ceur-ws.org/Vol-2898/paper07.pdf>.
- [105] Z. Seidametova, Combining programming and mathematics through computer simulation problems, CEUR Workshop Proceedings 2732 (2020) 869–880.
- [106] T. V. Shabelnyk, S. V. Krivenko, N. Y. Rotanova, O. F. Diachenko, I. B. Tymofieieva, A. E. Kiv, Integration of chatbots into the system of professional training of Masters, CEUR Workshop Proceedings 2879 (2020) 212–220.

Computational modelling of stochastic processes for learning research

Oleksandr H. Kolgatin¹, Larisa S. Kolgatina² and Nadiia S. Ponomareva^{3,4}

¹Simon Kuznets Kharkiv National University of Economics, 9A Science Ave., Kharkiv, 61166, Ukraine

²H. S. Skovoroda Kharkiv National Pedagogical University, 29 Alchevskiyh Str., Kharkiv, 61002, Ukraine

³Kryvyi Rih State Pedagogical University, 54 Gagarin Ave., Kryvyi Rih, 50086, Ukraine

⁴Kharkiv University of Technology "STEP", 9/11 Malomyasnytska Str, Kharkiv, 61000, Ukraine

Abstract

The objectives of our work were to use computer-based statistical modelling for comparison and systematisation of various approaches to non-parametric null hypothesis significance testing. Statistical model for simulation of null hypothesis significance testing has been built for educational purpose. Fisher's angular transformation, Chi-square, Mann-Whitney and Fisher's exact tests were analysed. Appropriate software has been developed and gave us possibility to suggest new illustrative materials for describing the limitations of analysed tests. Learning researches as the method of understanding inductive statistics have been suggested, taking into account that modern personal computers provide acceptable time of the simulations with high precision. The obtained results showed low power of the most popular non-parametric tests for small samples. Students can't analyse the test power at traditional null hypothesis significance testing, because the real differences between samples are unknown. Therefore, it is necessary to change the accents in Ukrainian statistical education, including PhD studies, from using null hypothesis significance testing to statistical modelling as a modern and effective method of proving the scientific hypotheses. This conclusions correlate with observed scientific publications and the recommendation of the American Statistical Association.

Keywords

computational modelling, computer-based simulation, statistical hypothesis significance testing, education, learning research

1. Introduction

1.1. Statement of the problem

Computational modelling and using the computer-based models for simulation is an essential part of educational content and methodology. From one hand, computer-based simulation

CoSinE 2021: 9th Illia O. Teplytskyi Workshop on Computer Simulation in Education, co-located with the 17th International Conference on ICT in Education, Research, and Industrial Applications: Integration, Harmonization, and Knowledge Transfer (ICTERI 2021), October 1, 2021, Kherson, Ukraine

✉ kolgatin@ukr.net (O. H. Kolgatin); LaraKL@ukr.net (L. S. Kolgatina); ponomareva.itstep@gmail.com (N. S. Ponomareva)

🌐 <http://www.is.hneu.edu.ua/?q=node/294> (O. H. Kolgatin); <http://hnpu.edu.ua/uk/kolgatina-larysa-sergiyivna> (L. S. Kolgatina); <https://tinyurl.com/5xc89ntp> (N. S. Ponomareva)

🆔 0000-0001-8423-2359 (O. H. Kolgatin); 0000-0003-2650-8921 (L. S. Kolgatina); 0000-0001-9840-7287 (N. S. Ponomareva)



© 2022 Copyright for this paper by its authors.
Use permitted under Creative Commons License Attribution 4.0 International (CC BY 4.0).

CEUR Workshop Proceedings (CEUR-WS.org)

becomes one of the main method of pedagogical research that brings new facilities in forecast and proving the efficiency of new pedagogical technologies. From the other hand computational modelling and computer-based simulations provided by students give them new experience in difficult sided of educational content, facilitate competences in independent work and researcher's competences [1]. Thus, students' learning research with computational simulations has been developed as a method for improving students' self management through creative learning activity [2, 3]. Semerikov et al. [4, 5] have suggested to use computer simulation of neural networks using spreadsheets. These results give us possibility to introduce this modern technology in educational process of wide kinds of educational programs that are not directly connected with computer science. The elements of technique of using CoCalc at studying topic "Neural network and pattern recognition" of the special course "Foundations of Mathematic Informatics" are shown in the works of Markova et al. [6]. The method of computational simulation and modelling is supported by work of Modlo and Semerikov [7], where new tools for modelling of electromechanical technical objects in cloud-based learning environment have been suggested. Khazina et al. [8] also considered computer modelling as a scientific means of training. So we can conclude that computational modelling and simulation is the popular and actual learning method. This field of research is very interesting for our present study, because it promotes development of computational modelling as a method of learning researches.

One of such fields of pedagogical investigations, where new information technologies can provide new level of understanding the modelled processes, is comparative pedagogical experiment and statistical hypothesis testing as a part of one. Computer-based statistical analysis becomes a major part of the monitoring of the learning resources quality [9]. In our work, we consider statistical processing of results of pedagogical experiment as one aspect of pedagogical research. Traditionally this problem is solved by methods of mathematical statistics on the basis of statistical hypothesis testing. Two hypotheses are put forward: the null hypothesis, which states that there are no differences between compared random variables in the studied parameter, and the alternative hypothesis, which argues that the observed differences are caused by the studied impact. A researcher uses some criterion that integrates the observed differences in the numeric form and calculates the probability of obtaining the same or larger differences in random process to accept one of those hypothesises. The number of participants in pedagogical studies is usually small, so we accept alternative hypothesis, if the probability of the type I error (the probability that the observed differences are due to random factors) does not exceed 5 %. Understanding the essence of statistical hypothesis testing is a hard problem. Thus, Sotos et al. [10] pointed the common misconceptions about statistical inference. They noted that in response to the persistence of the misconceptions, educational researchers and practitioners have initiated and promoted a thorough reform for teaching statistics. And one direction of this reform was the importance of integrating technology in the statistics classroom, using simulations to help students understand the ideas behind statistical processes [10]. Problems of using statistical hypothesis tests are so deep that discussions continue even now, after more than a hundred years after implementation this approach into the science. For example, scientists discuss the problem of dichotomization of p-values, because it makes matters worse (Wasserstein et al. [11]) and suggest to describe the data using other approaches (McShane et al. [12]). The use of computer-based modelling provides a new look at the system of inductive methods of statistics, gives possibility to highlight the most powerful methods and to determine

the limits of their applicability, which is particularly important in psychological and pedagogical studies, where samples are small [13].

Otherwise, the practice of statistical data analysis in Ukrainian pedagogical researches is grounded on traditional approach. So we need to show educational community modern computer-based techniques for data analysis that are based on simulation of stochastic processes. We also need to show comparison of these techniques with traditional criteria for null hypothesis significance testing. This work is devoted to simulation of using popular classical criteria of statistical hypothesis testing: Pearson's criterion Chi-square, Fisher's angular transformation and Mann-Whitney U criterion. Information and communication technologies offer new perspectives for the analysis of the boundaries of these tests application, investigation of the criteria sensitivity, development of approaches to statistical analysis for small samples. Learning researches with appropriate models will be useful not only for students, but also for researchers to improve understanding the essence of statistical data processing in pedagogic research.

1.2. Analysis of previous research

Last time researchers pay great attention for statistical modelling as an alternative approach to prove research hypotheses. Computer-based simulation has provided possibility to show the boundaries of using Pearson's criterion Chi-square at null hypothesis significance testing (Kolgatin [13]). Computational model for investigating the efficiency of statistical hypothesis testing was proposed. This model did not use any assumptions about probability distribution and test features. So it could be used for comparison of methods built on different principles. There was shown that Chi-square test and Fisher's angular transformation test in the studied range of sample sizes (from 9 to 200) do not provide good accuracy for frequency tables with 2 categories. The idea of these tests is to guarantee that we should obtain the error of the first type (type I error) in 5 % cases (5 % significance level were used), if the null hypothesis is true. Real value of the type I error was essentially differ within the interval from 0.04 to 0.08 instead of 0.05. Accuracy of the type I error estimation is better (in the interval from 0.04 to 0.06), if the sizes of samples are not less than 70. Accuracy of the type I error estimation by Chi-square test for frequency tables with 3 categories is better even for very small samples sizes. This accuracy essentially depends on the number of measures in samples and is worse, when one of the sample is small and the other one is large. Therefore, some recommendations for combining categories to use the chi-square test for small sample sizes are debatable. Another result that was obtained in [13] is devoted to Chi-square test power, its ability to show differences between distributions. The type II error was quite high, it decreased with increasing the sample sizes, when 3 categories in frequencies tables were used instead of 2 categories. This question is discussed in this paper later in detail, but we can conclude here that this results correlate with the statement of the American Statistical Association (ASA) about the limitations of p values (Wasserstein and Lazar [14]).

Statistical modelling as a powerful alternative to null hypothesis significance testing was described by Lang et al. [15]. They noted that statistical modelling is a more complicated approach than null hypothesis significance testing, but this added complexity affords researchers the opportunity to quantify evidence in support of specific substantive hypotheses relative to

competing hypotheses — not simply against a null hypothesis [15]. The authors underlined that the purpose of statistical modelling is to represent, as accurately and completely as possible, a data generation process, with the goal of understanding and gathering evidence about its structure [15]. These authors suggested and compared Bayesian and “frequentist” models for exploring how child temperament mediates the relationship between age and developmental progress in communication and motor skills [15].

Statistical modelling as an educational tool is analysed in many scientific works. A good review on the corresponded literature was suggested by Jamie [16]. The main idea of the authors is to use computer simulation methods (CSMs) for the purpose of clarifying abstract and difficult concepts and theorems of statistics. Some systems of computer mathematics and spreadsheets are considered: SAS PROC IML, Excel, MINITAB, SAS, SPSS. There was analysed the approaches to teach and illustrate such parts of statistical education: central limit theorem, Student’s t-distribution, confidence intervals, binomial distribution, regression analysis, sampling distribution, survey sampling [16].

Many of the models for modelling the statistical hypothesis testing with educational purpose was suggested at the end of last century. Flusser and Hanna [17] have used BASIC computer programs to simulate a binomial experiment and test a simple statistical hypothesis. Taylor and Bosch [18] suggested interactive clinical trial simulation program that provides a few thousand simulations in about 5 minutes. Bradley et al. [19] have developed a comprehensive simulation laboratory for statistics that could work with real experimental data from database and generate samples according to given parameters. This software calculated p-value according F-test. Students could see that the decisions about the null hypothesis differ for various series and analyse the Type I and Type II errors. Ricketts and Berry [20] used statistical modelling in a package Resampling Stats to demonstrate a histogram of Differences between means. This results, obtained for very small samples, helped students to understand the essence of null hypothesis significance testing without any formulas.

This software gave possibility to demonstrate the Type I and Type II errors for students, but did not produce enough performance for analysing the qualities of used criteria. Therefore, it is actual to develop some computer-based model for comparison of various approach for null hypothesis significance testing and analysing boundaries of its using. Such model will be useful not only for understanding the essence of null hypothesis significance testing, but it will be also useful for understanding the limitation of the traditional null hypothesis significance testing approach and will motivate pedagogical scientists to computational modelling as a perspective method of statistical data analysis.

1.3. Objectives

We have started this work in 2014 with the objectives to use computer-based statistical modelling for comparison and systematisation of various approaches to non-parametric null hypothesis significance testing. The accessible for Ukrainian students information in textbooks and handbooks was contradictory and not enough for confident and reasonable choice of the statistical method for data analysis in pedagogical researches. We have tried to develop a statistical model for providing learning researches with null hypothesis significance testing by university and postgraduate students.

But now we are finishing this work with the objectives to prove advantage of statistical modelling over null hypothesis significance testing. We are grounding on our own simulations, stormy development of information and communication technologies and newest publications in statistical scientific literature. The aim of this research is to show the limitations of classical null hypothesis significance testing and motivate students and researchers to computational modelling as an effective method of research hypotheses proving.

Such changing the objectives of our study leads to some inconsistency of this paper and deprives us of opportunities to introduce this analysis directly into educational process, because the program of statistical education should be revised taking into account obtained result. So we can suggest our results as a matter for critical thinking and developing educational programs to statistical educators.

2. Theoretical framework

Statistical modelling of various criteria for null hypothesis significance testing needs in preparing procedures of these criteria implementation. More over, some criteria, such as Pearson's Chi-square, Fisher's angular transformation, needs data in a form of frequency table. Our model generates the samples in metric scale, so the data should be collapsed into some intervals to obtain the frequency table.

Pearson's Chi-square criterion was used in the form:

$$\chi^2 = \sum_{i=1}^m \sum_{j=1}^k \frac{(E_{i,j} - T_{i,j})^2}{T_{i,j}}, \quad (1)$$

where $E_{i,j}, T_{i,j}$ – empirical and theoretical frequencies; i, m – index and number of categories; j, k – index and number of samples ($k = 2$ in this study).

The form of Chi-square criterion with Yates's correction for continuity was analysed by D'Agostino et al. [21], Kolgatin [22] and was not used here. All studies in this work were carried out for significance level of 5 %, the critical values of Chi-square criterion were assumed according to Verma [23].

The criterion of Fisher's angular transformation was used for 2-tails in such form:

$$\varphi^* = 2 \cdot \left| \arcsin \left(\frac{E_{1,1}}{n_1} \right) - \arcsin \left(\frac{E_{1,2}}{n_2} \right) \right| \sqrt{\frac{n_1 \cdot n_2}{n_1 + n_2}}, \quad (2)$$

where $E_{1,1}$ and $E_{1,2}$ – frequencies in one of the categories for samples 1 and 2; n_1 and n_2 – sizes of samples 1 and 2 [24]. The critical value of this criterion was assumed 1.96 at significance level of 5 % (2-tail). Mostly, Fisher's angular transformation is used for 1-sided test with critical value 1.64 [24]. The test power is higher in such case [13]. We used 2-sided test in this work to have correct comparison with Pearson's Chi-square test, which has no 1-sided form.

The words “exact test” are magical for some students and even researchers. Fisher's exact test for consistency in a 2×2 table was analysed by D'Agostino et al. [21], Berkson [25], Liddell [26] etc. Their results were pessimistic. All these researchers believed that this test is exact only because it do not use any approximations. Theoretical basis of this test is not exact, so let try

our simulations to understand and illustrate the problem. We have used 2-sided form of the Fisher's exact test criterion, which give us the p-value (probability of the Type I error) [27, 28]. The probability of given observed frequencies combination can be calculated with the formula:

$$p^* = \frac{(n_1)!(n_2)!(n_a)!(n_b)!}{a_1!b_1!a_2!b_2!n!}, \quad (3)$$

where a_1, b_1, a_2, b_2 – observed frequencies in the samples A and B in the categories 1 and 2 accordantly; $n = a_1 + a_2 + b_1 + b_2$ – total number of measures; $n_1 = a_1 + b_1$ – number of measures in the category 1; $n_2 = a_2 + b_2$ – number of measures in the category 2; $n_a = a_1 + a_2$ – the size of the sample A ; $n_b = b_1 + b_2$ – the size of the sample B .

The probability of random realisation of given combination and all other less probable combinations is

$$p = p^* + \sum_{\forall p_i < p^*, i \in [0; n_a]} p_i, \quad (4)$$

where

$$p_i = \frac{(n_1)!(n_2)!(n_a)!(n_b)!}{(i)!(n_1 - i)!(n_a - i)!(n_b - n_a + i)!n!}. \quad (5)$$

Mann-Whitney test and its modifications are the field of researchers' attention now and statistical modelling is the main method of comparison the efficiency of various modifications [29, 30]. The assumptions of this group of test were analysed by Fay and Proschan [31].

Mann-Whitney test was used in our work based on research by Sidorenko [32], Gubler and Genkin [24], Billiet [33] in the form

$$U = \min(U_a, U_b), \quad (6)$$

where

$$U_a = (n_a n_b) + \frac{n_a (n_a + 1)}{2} - T_a, \quad (7)$$

$$U_b = (n_a n_b) - U_a, \quad (8)$$

where n_a and n_b – the sizes of A and B samples accordantly; T_a – the sum of ranks in the sample A . The calculated values of Mann-Whitney criterion were compared with its critical values according the table, when both n_a and n_b were not grater than 30 [33]. Z-test for U criterion was used in cases, where at least one of the sample size was grater than 30 [33]:

$$Z = \frac{U - \frac{1}{2}n_a n_b}{\sqrt{\frac{n_a n_b (n_a + n_b + 1)}{12}}}. \quad (9)$$

3. Statistical model

The method of statistical modelling was used for investigation. The model allows to form 2 samples from one population or from different populations that have some differences in its probability distributions.

The first regime was used for Type I error investigation. Two series of numbers was created on the base of the same random number generator. The values obtained were distributed into m categories, we could control the distribution to ensure uniform distribution or the predominance of frequencies in certain categories; an empirical value of criterion was calculated for obtained frequencies tables and compared with the critical value of this criterion at the specified level of significance; decision about the possibility of rejection of the null hypothesis was made. We knew that actually the null hypothesis was true, because both samples (series of numbers) were generated with one random number generator. But the alternative hypothesis was accepted in some of the tests as a result of random factors. The relative frequency of such false decisions was estimated as the probability of a type I error and should correspond to the significance level that was used to choose critical value of a criterion.

We needed a large number of trials to obtain a satisfactory precision of the analysis. 1000000 trials were conducted in computational experiments for each case. The precision of the obtained values of the probability of a type I error was estimated on the base of the standard deviation in consecutive identical trials. The estimated absolute error was about 0.0005 for 95 % confidence interval. So we used all numbers with 2-3 significant digits and the last digit in all shown results is spare guard digit. We need in a guard digit for further data processing. The number of trials can be less in students' investigations for saving computational time when the power of tests are analysed. In some of the trials with very small samples were obtained zero values of the frequencies in some categories, and it was not possible to calculate the values of a criterion. These results were removed from the analysis, and, if their part in the total number of trials exceeded 1 %, the study under appropriate conditions was not conducted.

The second regime was used for investigation the power of the tests. Two unequal random number generators were used to analyse of criteria sensitivity. In such case we knew that actually the alternative hypothesis is true, because samples (series of numbers) were generated with different random number generator. We could control the level of variation. The relative frequency of true positive decisions corresponds to the criterion power that determined by the level of differences between the parameters of random number generators, which are used for samples.

4. Learning researches

4.1. Motivation with leading questions

One of the method to motivate students for learning research is to suggest them leading questions after a brief theoretical review [2]. Such questions attract students' attention to the most problem and debatable issues of the educational content. The limitation of using some theory, accuracy estimation, possible practical problems in specific cases are always the problem not only for students, but also for professional researchers. Concerning to the statistical education in using null hypothesis significance testing we would suggest students such leading questions:

- Is Type I error fixed, when null hypothesis significance testing?
- What factors affect the power of the null hypothesis significance testing?

Table 1

Type I error, when null hypothesis is true (example for equivalent samples sizes)

Size of the sample A	Size of the sample B	Frequency of null hypothesis rejection using the test, %					
		Pearson Chi-Square test for the number of categories			Fisher's angular transformation	Fisher's exact test	Mann-Whitney test
		2	3	5			
4	4	7.07				0.79	
5	5	6.05				2.17	3.18
6	6	5.79				0.63	4.11
7	7	5.71				1.29	3.81
8	8	7.64				2.09	4.96
9	9	4.99			9.02	2.10	4.01
10	10	4.21	4.83		4.84	1.26	4.03
<i>data storing continue with the step given by a teacher</i>							
198	198	5.01	5.02	5.02	5.01	3.95	5.00
199	199	5.07	5.04	5.01	5.07	4.00	4.98
200	200	5.10	5.00	5.04	5.01	4.02	4.96

- Should we collapse metric scale data into some intervals?
- Which tests should we use for small samples?
- What can we know about the test power when implement null hypothesis significance testing in practice?
- Can we prove that null hypothesis is true?

Students find the answers on these leading questions during independent work according to the plan of learning research. The answers can be not determined. So the process of making conclusions is creative for students.

Students should be equipped with the clear instruction for research steps and data collection. Also, some templates for conclusions should be prepared. We'll show the examples of tables and diagrams as possible results of investigations. The details of instructional materials is determined by the level of readiness of students for independent work.

4.2. Learning research of the non-parametric criteria performance with true null hypothesis

Now we will refer to students. You know some recommendations about limitations in using some null hypothesis significance tests. But how important are each of these limitations? What error can took place in each practical case of the test using. Textbooks do not give us detailed information. We can find the answers in professional research papers, but, may be, this source of information is not so easy to use. May be, some practical questions was not analysed in scientific works yet. So we need to master the method of statistical modelling to explore some specific practical problems. Study the above statistical model and use it to test non-parametric criteria performance with true null hypothesis. This model tries to use Pearson's Chi-square, Fisher's angular transformation, Fisher's exact test for consistency in a 2×2 table, Mann-Whitney test for testing null hypothesis for 2 samples of some given probability distribution. Both samples

Table 2

Conclusions according the accuracy of Type I error estimation with analysed tests

Templates	
Accuracy of Type I error estimation with analysed tests was	? <i>better</i> / <i>worse</i> when processing the data organised in 2 categories
Accuracy of Type I error estimation with analysed tests	? <i>disimproved</i> / <i>improved</i> with increasing the sizes of samples
The matter of the observed periodical behaviour of Type I error estimation at using Fisher's exact test for 2x2 frequency tables (2 categories) is	? <i>discrete matter of the base model of the criterion</i> / <i>low accuracy of statistical simulations</i>
The matter of the observed periodical behaviour of Type I error estimation at using Fisher's angular transformation and Pearson's Chi-square test for 2x2 frequency tables (2 categories) is	? <i>aproximation error and discrete matter of the criteria</i> / <i>low accuracy of statistical simulations</i>
Fisher's exact test was	? <i>less conservative</i> / <i>more conservative</i> than Fisher's angular transformation and Pearson's Chi-square test for 2x2 frequency tables (2 categories)
Collapsing data of small size samples into less number of categories	? <i>didn't lead to</i> / <i>led to</i> improving Type I error estimation
The observed behaviour	? <i>can differ</i> / <i>will be the same</i> in simulations with another probabilities distribution in population and another sizes of samples

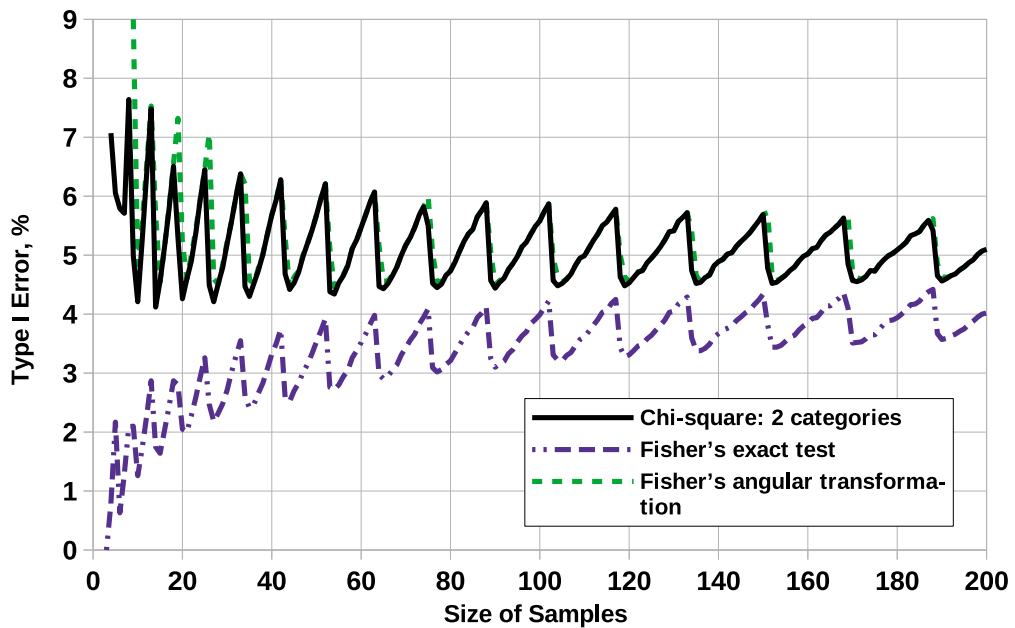

Figure 1: Accuracy of Type I error estimation in Fisher's angular transformation, Chi-square and Fisher's exact tests for 2 categories for samples of equal sizes $n_a = n_b = 4...200$.

are the random samples from the unique population. So, the ideal test should decline the null hypothesis in 5 % cases (Type I error on significance level 5 %). Try your simulations for given probability distribution in population according to your individual variant and fill in the table 1. It will be useful to create this table in some spreadsheet by copying the data from the used

Table 3

Conclusions according the power of analysed tests with given data

Templates
Collapsing data of small size samples into less number of categories ? ^{didn't lead to} _{led to} improving the power of null hypothesis significance testing
Power of the analysed tests ? ^{disimproved} _{improved} with increasing the sizes of samples asymptotically
To satisfy the Type II error less than 5 % (power grater than 95 %) at using Chi-square test for 2x2 frequency tables (2 categories) we needed samples sizes $n_a = \underline{\hspace{2cm}}$ and $n_b = \underline{\hspace{2cm}}$
To satisfy the Type II error less than 5 % (power grater than 95 %) at using Chi-square test for 3x2 frequency tables (3 categories) we needed samples sizes $n_a = \underline{\hspace{2cm}}$ and $n_b = \underline{\hspace{2cm}}$
To satisfy the Type II error less than 5 % (power grater than 95 %) at using Chi-square test for 5x2 frequency tables (5 categories) we needed samples sizes $n_a = \underline{\hspace{2cm}}$ and $n_b = \underline{\hspace{2cm}}$
To satisfy the Type II error less than 5 % (power grater than 95 %) at using Fisher's exact test for 2x2 frequency tables (2 categories) we needed samples sizes $n_a = \underline{\hspace{2cm}}$ and $n_b = \underline{\hspace{2cm}}$
To satisfy the Type II error less than 5 % (power grater than 95 %) at using Fisher's angular transformation test for 2x2 frequency tables (2 categories) we needed samples sizes $n_a = \underline{\hspace{2cm}}$ and $n_b = \underline{\hspace{2cm}}$
To satisfy the Type II error less than 5 % (power grater than 95 %) at using Mann-Whitney test we needed samples sizes $n_a = \underline{\hspace{2cm}}$ and $n_b = \underline{\hspace{2cm}}$
The analysed tests can be ranged according to their power in the such order: 1. (with the most power) _____; 2. _____; 3. _____; 4. _____; 5. _____; 6. _____
Power of some analysed tests can be improved in the case of one-sided hypothesis testing: 1. _____; 2. _____
The observed behaviour ? ^{can differ} _{will be the same} in simulations with another probabilities distribution in population and another sizes of samples

software output. Draw diagrams according to the obtained data (see the examples on figure 1 and figure 2). Analyse your results and draw conclusions according to the templates in the table 2.

4.3. Learning research of the non-parametric criteria power

We continue to refer to students. Let analyse the power of the tests. You remember that, according to the rules, we reject the null hypothesis, if the test allows us. But we never say that we accept the null hypothesis. We should say that we can not reject it. Now we should understand the matter of such rule. Use the null hypothesis significance test for two samples with different probability distributions obtained by different random generators with given

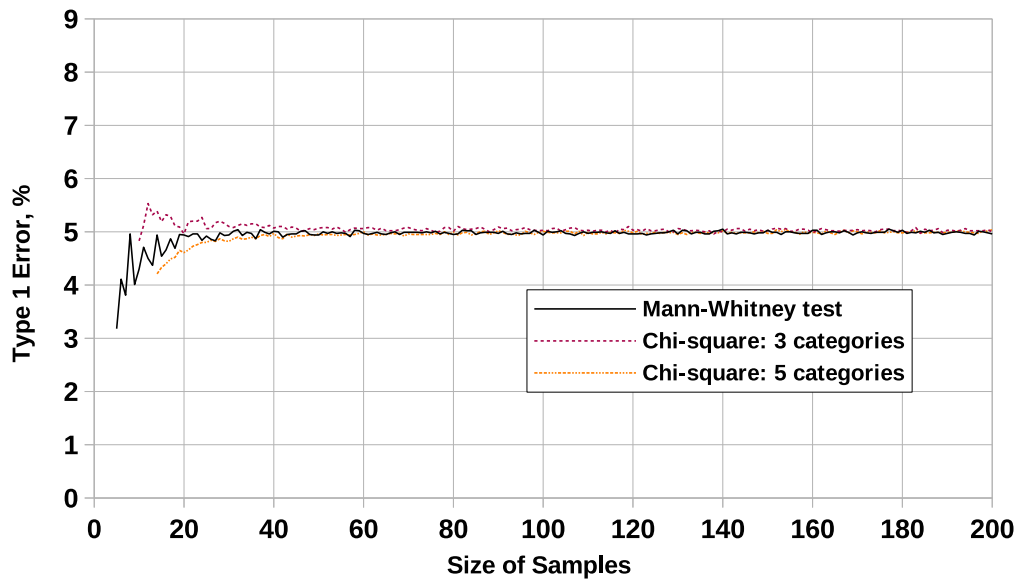

Figure 2: Accuracy of Type I error estimation in Mann-Whitney and Chi-square tests for samples of equal sizes $n_a = n_b = 5 \dots 200$.

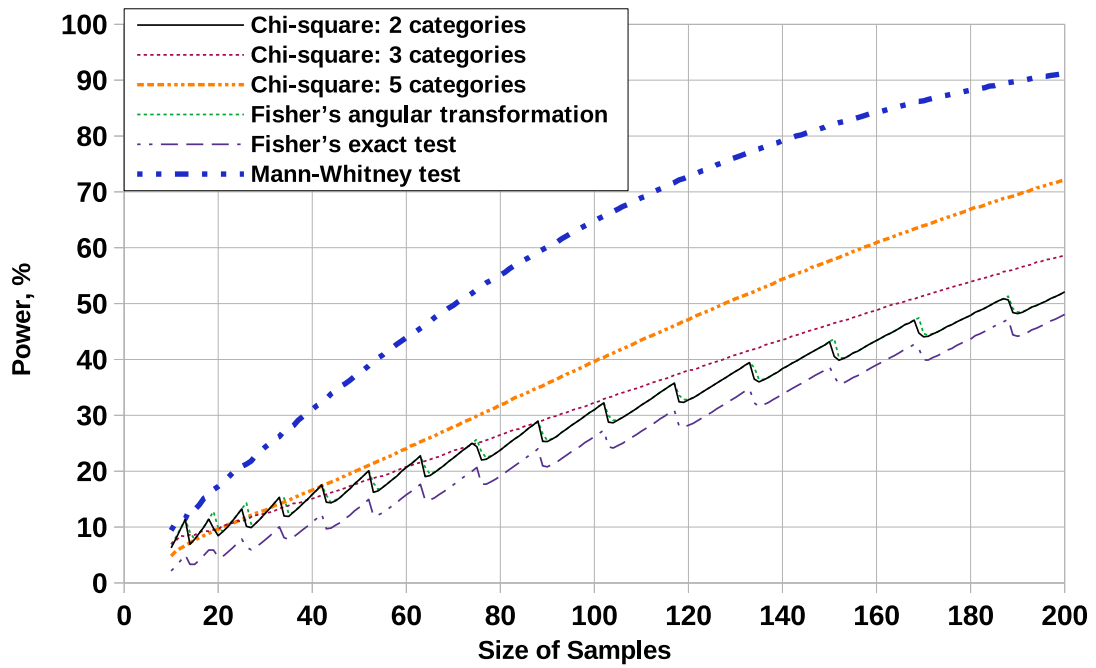

Figure 3: Power of Fisher's angular transformation, Chi-square, Mann-Whitney and Fisher's exact tests for samples of equal sizes with uniform probability distributions in diapasons $[-0.05; 0.95]$ and $[0.05; 1.05]$.

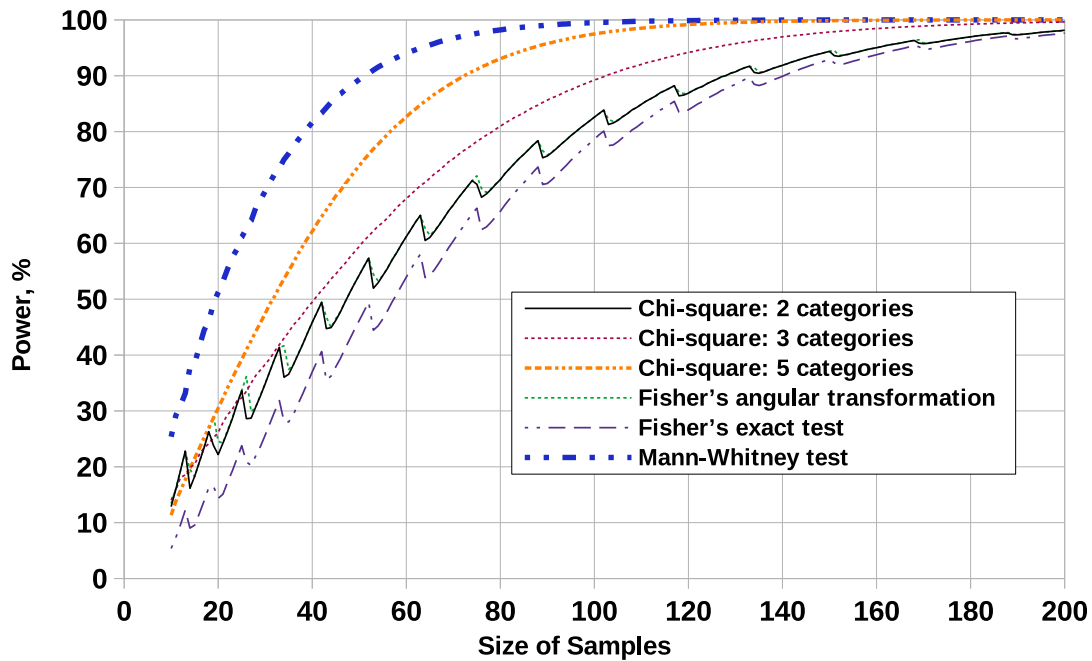

Figure 4: Power of Fisher's angular transformation, Chi-square, Mann-Whitney and Fisher's exact tests for samples of equal sizes with uniform probability distributions in diapasons $[-0.1; 0.9]$ and $[0.1; 1.1]$.

different parameters (according to your individual variant). Store the results in the form of the table 1. The form is the same, but now we know that null hypothesis is false. So the data in the table will show the power of the tests. Organise your data using diagrams and show the theoretical probability distribution in your samples, using the information about your random generator. We have used the uniform random generators with different means to obtain the examples (see figure 3, figure 4, figure 5). Analyse your results and draw conclusions according to the templates in the table 3.

As we can see, the main problem at using null hypothesis significance testing is unknown power of tests in practical tasks. The power of tests will be low, if null hypothesis is false with low differences between compared populations. The tests do not give us mechanism to estimate the power in such cases. So statistical modelling is more appropriate method of data analysing, because the model give us possibility to estimate data distribution and confidence intervals.

5. Conclusions

Statistical model for simulation of null hypothesis significance testing has been built. Fisher's angular transformation, Chi-square, Mann-Whitney and Fisher's exact tests were analysed. Appropriate software has been developed and gave us possibility to suggest new illustrative materials for describing the limitations of analysed tests.

Learning researches in inductive statistics have been suggested on the base of statistical modelling. This didactic materials can be useful for master and PhD students in pedagogics.

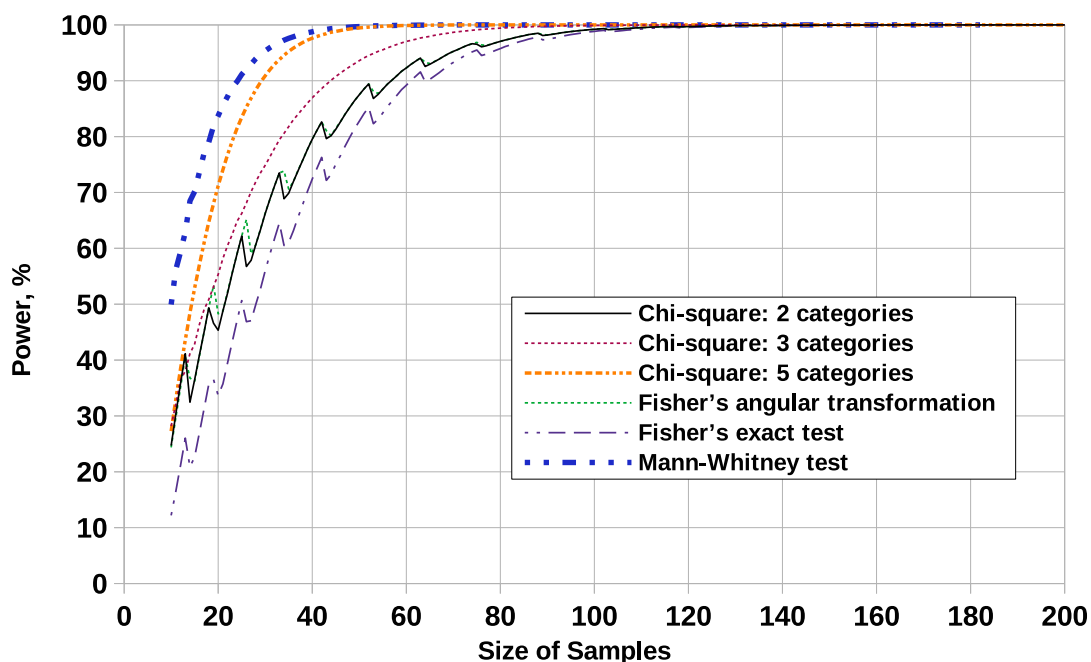

Figure 5: Power of Fisher's angular transformation, Chi-square, Mann-Whitney and Fisher's exact tests for samples of equal sizes with uniform probability distributions in diapasons $[-0.15; 0.85]$ and $[0.15; 1.15]$.

Suggested methods contain new views on the use of null hypothesis significance testing. We stress that collapsing data into less number of categories decrease the efficiency of tests and does not give any advantage in accuracy of significance level providing.

We suggest to change the accents in Ukrainian statistical education, including PhD studies, from using null hypothesis significance testing to statistical modelling as a modern and effective method of proving the scientific hypotheses. We ground on results of our simulations suggested in this paper, possibilities of modern information and communication technologies, literature review and the opinion of American Statistical Association.

The field of further research is in developing the courseware for teaching the inductive statistics based on statistical modelling. Studying the null hypothesis significance tests should be considered as an auxiliary simplified methods.

References

- [1] O. H. Kolgatin, L. S. Kolgatina, N. S. Ponomareva, E. O. Shmeltser, A. D. Uchitel, Systematicity of students' independent work in cloud learning environment of the course "Educational Electronic Resources for Primary School" for the future teachers of primary schools, in: S. Semerikov, V. Osadchyi, O. Kuzminska (Eds.), Proceedings of the Symposium on Advances in Educational Technology, AET 2020, University of Educational Management, SciTePress, Kyiv, 2022.

- [2] L. I. Bilousova, L. S. Kolgatina, O. H. Kolgatin, Computer simulation as a method of learning research in computational mathematics, CEUR Workshop Proceedings 2393 (2019) 880–894.
- [3] L. I. Bilousova, O. H. Kolgatin, L. S. Kolgatina, O. H. Kuzminska, Introspection as a condition of students’ self-management in programming training, in: S. Semerikov, V. Osadchyi, O. Kuzminska (Eds.), Proceedings of the Symposium on Advances in Educational Technology, AET 2020, University of Educational Management, SciTePress, Kyiv, 2022.
- [4] S. O. Semerikov, I. O. Teplytskyi, Y. V. Yechkalo, A. E. Kiv, Computer Simulation of Neural Networks Using Spreadsheets: The Dawn of the Age of Camelot, CEUR Workshop Proceedings 2257 (2018) 122–147.
- [5] S. O. Semerikov, I. O. Teplytskyi, Y. V. Yechkalo, O. M. Markova, V. N. Soloviev, Computer Simulation of Neural Networks Using Spreadsheets: Dr. Anderson, Welcome Back, CEUR Workshop Proceedings 2393 (2019) 833–848.
- [6] O. Markova, S. Semerikov, M. Popel, CoCalc as a learning tool for neural network simulation in the special course “Foundations of mathematic informatics”, CEUR Workshop Proceedings 2104 (2018) 388–403.
- [7] Y. O. Modlo, S. O. Semerikov, Xcos on Web as a promising learning tool for Bachelor’s of Electromechanics modeling of technical objects, CEUR Workshop Proceedings 2168 (2018) 34–41.
- [8] S. A. Khazina, Y. S. Ramskyi, B. S. Eylon, Computer modeling as a scientific means of training prospective physics teachers, in: EDULEARN16 Proceedings, 8th International Conference on Education and New Learning Technologies, IATED, 2016, pp. 7699–7709. doi:10.21125/edulearn.2016.0694.
- [9] H. M. Kravtsov, Methods and technologies for the quality monitoring of electronic educational resources, CEUR Workshop Proceedings 1356 (2015) 311–325.
- [10] A. E. C. Sotos, S. Vanhoof, W. V. den Noortgate, P. Onghena, How confident are students in their misconceptions about hypothesis tests?, Journal of Statistics Education 17 (2009). doi:10.1080/10691898.2009.11889514.
- [11] R. L. Wasserstein, A. L. Schirm, N. A. Lazar, Moving to a World Beyond “ $p < 0.05$ ”, The American Statistician 73 (2019) 1–19. doi:10.1080/00031305.2019.1583913.
- [12] B. B. McShane, D. Gal, A. Gelman, C. Robert, J. L. Tackett, Abandon Statistical Significance, The American Statistician 73 (2019) 235–245. doi:10.1080/00031305.2018.1527253.
- [13] O. Kolgatin, Computer-based simulation of stochastic process for investigation of efficiency of statistical hypothesis testing in pedagogical research, Journal of Information Technologies in Education (ITE) (2016) 007–014. URL: <http://ite.kspu.edu/index.php/ite/article/view/101>. doi:10.14308/ite000582.
- [14] R. L. Wasserstein, N. A. Lazar, The ASA Statement on p-Values: Context, Process, and Purpose, The American Statistician 70 (2016) 129–133. doi:10.1080/00031305.2016.1154108.
- [15] K. M. Lang, S. J. Sweet, E. M. Grandfield, Getting beyond the Null: Statistical Modeling as an Alternative Framework for Inference in Developmental Science, Research in Human Development 14 (2017) 287–304. doi:10.1080/15427609.2017.1371567.
- [16] D. M. Jamie, Using computer simulation methods to teach statistics: A review of the literature, Journal of Statistics Education 10 (2002). doi:10.1080/10691898.2002.11910548.

- [17] P. Flusser, D. Hanna, Computer simulation of the testing of a statistical hypothesis, *Mathematics and Computer Education* 25 (1991) 158. URL: <https://www.learntechlib.org/p/144840>.
- [18] D. W. Taylor, E. G. Bosch, CTS: A clinical trials simulator, *Statistics in Medicine* 9 (1990) 787–801. doi:10.1002/sim.4780090708.
- [19] D. R. Bradley, R. L. Hemstreet, S. T. Ziegenhagen, A simulation laboratory for statistics, *Behavior Research Methods, Instruments, and Computers* 24 (1992) 190–204. URL: <https://link.springer.com/content/pdf/10.3758/BF03203496.pdf>. doi:10.3758/BF03203496.
- [20] C. Ricketts, J. Berry, Teaching statistics through resampling, *Teaching Statistics* 16 (1994) 41–44. doi:10.1111/j.1467-9639.1994.tb00685.x.
- [21] R. B. D'Agostino, W. Chase, A. Belanger, The appropriateness of some common procedures for testing the equality of two independent binomial populations, *The American Statistician* 42 (1988) 198–202. URL: <http://www.jstor.org/stable/2685002>.
- [22] O. H. Kolgatin, Informatsionnyye tekhnologii v nauchno-pedagogicheskikh issledovaniyakh (Information technologies in educational researches), *Upravlyayushchiye Sistemy i Mashiny (Control Systems and Machines)* 255 (2015) 66–72.
- [23] J. P. Verma, *Data Analysis in Management with SPSS Software*, Springer, India, 2013. doi:10.1007/978-81-322-0786-3.
- [24] Y. V. Gubler, A. A. Genkin, *Primeneniye Neparametricheskikh Metodov Statistiki v Mediko-Biologicheskikh Issledovaniyakh (Application of Nonparametric Methods of Statistics in Biomedical Research)*, *Meditsina, Leningradskoye otdeleniye, Leningrad*, 1973.
- [25] J. Berkson, In dispraise of the exact test: Do the marginal totals of the 2x2 table contain relevant information respecting the table proportions?, *Journal of Statistical Planning and Inference* 2 (1978) 27–42. doi:10.1016/0378-3758(78)90019-8.
- [26] D. Liddell, Practical tests of 2×2 contingency tables, *Journal of the Royal Statistical Society. Series D (The Statistician)* 25 (1976) 295–304. doi:10.2307/2988087.
- [27] G. K. Kanji, *100 Statistical Tests*, SAGE Publications, London - Thousand Oaks - New Delhi, 2006.
- [28] K. J. Preacher, Calculation for Fisher's exact test, 2021. URL: <http://quantpsy.org/fisher/fisher.html>.
- [29] Y. Fong, Y. Huang, Modified Wilcoxon-Mann-Whitney test and power against strong null, *The American Statistician* 73 (2019) 43–49. doi:10.1080/00031305.2017.1328375.
- [30] A. Marx, C. Backes, E. Meese, H.-P. Lenhof, A. Keller, EDISON-WMW: Exact dynamic programming solution of the Wilcoxon-Mann-Whitney test, *Genomics, Proteomics and Bioinformatics* 14 (2016) 55–61. doi:10.1016/j.gpb.2015.11.004.
- [31] M. P. Fay, M. A. Proschan, Wilcoxon-Mann-Whitney or t-test? On assumptions for hypothesis tests and multiple interpretations of decision rules, *Statistics Surveys* 4 (2010) 1–39. doi:10.1214/09-SS051.
- [32] Y. V. Sidorenko, *Metody Matematicheskoy Obrabotki v Psikhologii (Methods of Mathematical Processing in Psychology)*, Rech, St. Petersburg, 2002. URL: <https://www.sgu.ru/sites/default/files/textdocsfiles/2014/02/19/sidorenko.pdf>.
- [33] P. Billiet, The Mann-Whitney U-test – analysis of 2-between-group data with a quantitative response variable, 2003. URL: <https://psych.unl.edu/psycrs/handcomp/hcman.PDF>.

A Petri net-based simulation of synchronized curriculum for IT-specialists' training

Lyudmyla I. Bilousova¹, Liudmyla E. Gryzun²

¹*Independent researcher, Professor, Kharkiv, Ukraine*

²*Simon Kuznets Kharkiv National University of Economics, 9A Nauky Ave., Kharkiv, Ukraine*

Abstract

The problems of synchronized curriculum shaping are discussed in the paper in the context of the challenges of contemporary IT specialists' training in terms of permanent evolution and rapid expansion of computing. The authors' technique of the curriculum simulation based on Petri net applying is presented. The theoretical framework which allowed us to elaborate the technique includes some didactical fundamentals of curriculum design and academic disciplines structuring as well as the theoretical basics of Petri nets in terms of their significant facilities for different processes synchronization. The technique of academic disciplines structuring based on frame model of knowledge representation is covered as a chain of stages which results in the net of disciplines modules (frames) including the proper learning elements along with preserving and spreading links between them. In order to solve the problem of synchronization of the learning elements mastering throughout the academic disciplines with regard of the established links in the frames, it is offered the practically-driven approach to curriculum modeling based on Petri nets simulation. The different types of the precedence relations for the learning elements (inputs and outputs of the frames) were distinguished. Using these precedence relations, we managed to simulate through Petri nets a learning element itself and the process of its mastering. Using the operations of Petri nets modifications and learning elements' connections of different types, we could obtain a model of a curriculum discipline module and finally – a curriculum discipline model. Built Petri nets models represent all the evolution of the learning elements mastering by students in the curriculum courses. Synchronization of their mastering is guaranteed by the rules of Petri net execution and modifications. The peculiarities of the offered technique are analyzed. The benefits in terms of applying such a simulation to the building of synchronized curriculum for IT-specialists training are formulated. The prospects of the research are outlined in the lines of using the obtained results for special software development.

Keywords

IT-specialists' training, synchronized curriculum, Petri net-based simulation, curriculum simulation

1. Introduction

Rapid development of IT industries and their penetration in all branches of social life as well as the modern shifts in the demand for computing throughout a global economy cause

CoSinE 2021: 9th Illia O. Teplytskyi Workshop on Computer Simulation in Education, co-located with the 17th International Conference on ICT in Education, Research, and Industrial Applications: Integration, Harmonization, and Knowledge Transfer (ICTERI 2021), October 1, 2021, Kherson, Ukraine

✉ lib215@gmail.com (L. I. Bilousova); Lgr2007@ukr.net (L. E. Gryzun)

🌐 <http://web.archive.org/web/20201027120942/http://hnpu.edu.ua/uk/bilousova-lyudmyla-ivanivna>

(L. I. Bilousova); <http://www.is.ksue.edu.ua/?q=node/295> (L. E. Gryzun)

🆔 0000-0002-2364-1885 (L. I. Bilousova); 0000-0002-5274-5624 (L. E. Gryzun)

© 2022 Copyright for this paper by its authors. Use permitted under Creative Commons License Attribution 4.0 International (CC BY 4.0).

 CEUR Workshop Proceedings (CEUR-WS.org)

growing requirements to potential IT-specialists' training. Consequently, this needs changes in computing education and demands innovative approaches to university curriculum building for training high level professionals in computing sphere.

In the international guidelines shaping the modern paradigms of global IT education, it is emphasized the transformation of computing which nowadays is not just a profession or a single knowledge domain [1, 2, 3, 4, 5, 6]. According to the current state of IT education covered in the latest Computing Curricula Series Report [5, 6], we can conclude that computing area (as a result of rapid evolution) is not an isolated domain, but rather a family of knowledge domains which embraces a set of fundamental and applied study areas. They go on their developing that leads to emerging of new study areas which represent intersection of fundamental science, applied branches of science and traditional computer disciplines.

In particular, it is mentioned that during recent decades the essential changes in IT industry have happened that led to the important changes in the disciplines [1, 2, 3, 4, 5, 6]:

- (1) Computer science has evolved into a more developed academic subject;
- (2) Computer engineering has raised from electrical engineering;
- (3) Software engineering as a discipline has emerged based on Computer science and Computer engineering;
- (4) Information systems has expanded throughout economic and organizational processes;
- (5) Information technology has appeared as a new discipline that encouraged building computing infrastructures and others.

The study areas continued to evolve, at the same time, increasing the range of study opportunities for pre-service IT-specialists and educational establishments. Additionally, many jobs emerged which concentrated on software use rather than on its development that accelerated the study areas and disciplines maturation.

It is also emphasized that in terms of globalization processes and permanent changes in computing, building of worldwide curricula is getting really urgent. Its development, on the one hand, has expanded the scope of the traditional computing disciplines. On the other hand, it raises the task of preserving the natural links between the disciplines, integrating of the newly-appeared disciplines into the existing curriculum, synchronization of their mastering.

Thus, it seems to be necessary not only to develop a proper approach to university curriculum building for potential computing specialists, but also to elaborate practically-driven means for its efficient modeling.

The *aim* of the paper is to represent authors' Petri nets-based approach to the building of synchronized curriculum for IT-specialists training.

2. Theoretical framework

Developing the approach to the simulation of synchronized curriculum, we addressed to the didactical fundamentals of curriculum design and academic disciplines structuring as well as the theoretical basics of Petri nets which have significant facilities for different processes synchronization.

According to a number of studies, in the process of curriculum design, one of the essential steps is made by the modular structuring of the disciplines which at the same time have

to reflect the content of proper scientific branches. The main challenge here is seen by the researchers in the proper shaping disciplines from modules, which would allow to keep existing links between the portions of knowledge (learning elements). It is pointed out, that building modular structure of disciplines without saving the links and desynchronized mastering of knowledge (skills) will cause the set of negative consequences and educational drawbacks (such as destroying the logic and wholeness of the accepting of the set of curriculum disciplines, shaping uncoordinated system of students' knowledge, inability to use them flexibly in related areas, and other [7, 8, 9, 10]). It is also emphasized in the studies (in particular, [6, 7, 8, 11, 12]) that nowadays it is urgent to find out the ways to build coordinated university curriculum in order to overcome the exposed problems, to cultivate interdisciplinary understanding of knowledge nature, to focus pre-service specialists on holistic mastering of learning content and forming their compound skills.

There are some special challenges in the sphere of IT university education and, subsequently, in curriculum building for IT-specialists' training (partially highlighted above). Among the principles of building global computing curriculum followed by the [6], it is essential to mention the set of important pillars which may become the guidelines for curriculum building in national university education:

- (1) it has to preserve the concept of computing throughout the world and in time, as well as to support existing, emerging and future computing disciplines both for the today and potential students;
- (2) it has to mind future trends and achievements from industry, research, and the entire spectrum of society;
- (3) it has to be flexible to get global enduring acceptance and be adaptable within multiple educational contexts.

Thus, trying to overcome the problems of disconnection between the curriculum disciplines, taking into consideration the main pillars of the building curriculum for IT-specialists training, and meeting the requirements of creation of holistic system of students' knowledge and skills, the authors has developed and implemented the technique of the module disciplines structuring based on the knowledge penetration. The said technique (that was covered in details in our earlier papers [12, 13]) can be represented in brief as follows.

This technique was elaborated by the authors basing on the concepts of the multilevel approach to the formation of learning content in the correspondence with different levels of knowledge generalization minding its AI sense [13]. In particular, there were applied such models of knowledge representation as semantic networks and frame-based models due to their relevant facilities to spread determined connections between knowledge units [14, 15].

Thus, the said technique of the curriculum building based on the knowledge penetration, embraces some stages matching the levels of the educational content building (which, in turn, match the levels of knowledge generalization).

The first stage of curriculum building corresponds to the so called "Super-Subject" level where the content is represented as a network of the concentrated units of knowledge (KPs shown in the figure 1). These units are preliminary defined basing on the analysis of the system of professional functions of the specialists, their job scope, current requirements to their expertise,

typical vocational tasks etc. Thus, these KPs include real elements the subject domain which are to be mastered by per-service specialists in the process of their training.

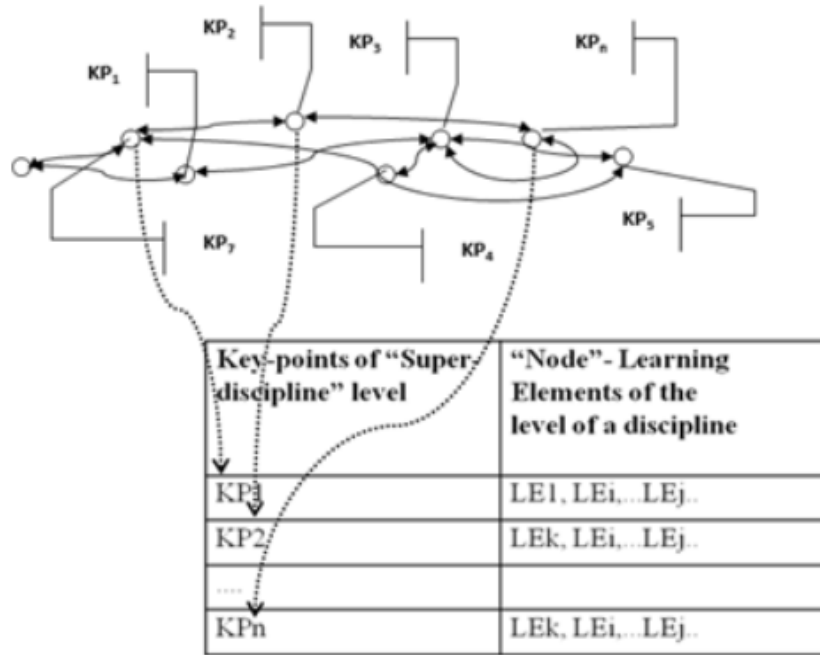

Figure 1: Grouping LEs of a subject domain around proper KPs of the Super-Subject level.

On the subsequent stages of the curriculum building, the content of discipline modules is concentrated around the KPs of the Super-Subject level.

At the next stage of the curriculum building (Subject level and the level of learning material) it is provided the deep analysis of the subject domain regarding its double essence: any curriculum subject is both a part of the educational content and the reflection of a scientific branch. The result of such an analysis (usually made with software like Trope, Text Analyst etc) is the system of the interconnected knowledge portions (Learning Elements, or LEs) that are grouped around proper KPs of the Super-Subject level (figure 1).

Then typical procedures for frame-based model of knowledge representation are implemented [14]. In particular, the frames-prototypes are built and filled in with the revealed LEs minding the links, determined at the previous stage. The links between LEs are able to be spread around other frames due to embedded facilities of frame based model. Applying similar procedures to all the curriculum subjects, we obtain the coordinated system of the disciplines which is sensitive to the changes happening on the highest level of education content and at the same time provide students with holistic system of knowledge and skills.

Schematically, the result of the curriculum building may be depicted as a diagram (figure 2) where each frame represents a curriculum subject with nested frames (modules) and connections between revealed LEs grouped around the KPs. Thus, the curriculum can be simulated as a net of modules modeled by the system of frames involving the LEs.

It is important to emphasize that the presented authors' technique of university curriculum

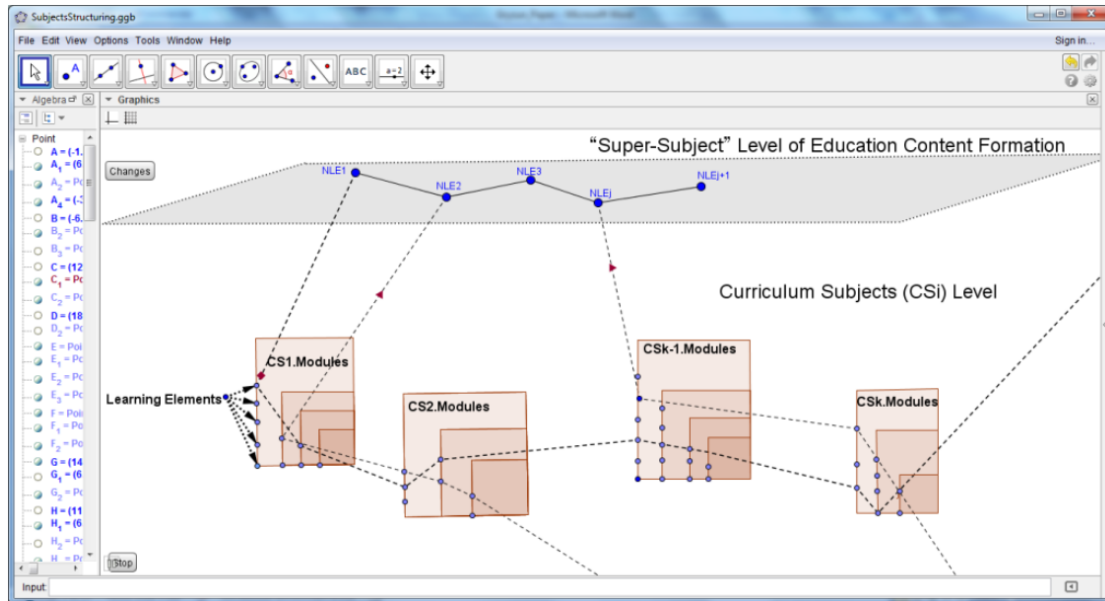

Figure 2: The result of the curriculum building where each frame represents a curriculum subject with nested frames (modules).

building which makes the theoretical and practical framework of our current research was based on the revealed mechanisms of knowledge integration in scientific branches and in curriculum disciplines and allows to trig the integration mechanisms realization. The technique of the disciplines structuring and coherent curriculum shaping was implemented and verified with the help of special expertise.

However, its analysis made us improve some of its steps. In particular, in the process of real curriculum building it became clear that it is necessary to elaborate the issue of the grouping learning elements into the modules. The problem is that the links between the LEs are reserved and spread thanks to the frames facilities. At the same time, it would be beneficial to take into account also the sequence and order of their learning within the modules and disciplines, and to make their mastering not only holistic, but also synchronized.

In this context it is relevant to use the simulation advantages of Petri nets apparatus as for the processes synchronization. Thus, it is necessary to cover in brief basics of Petri nets theory as a framework for our approach to curriculum synchronization.

According to Murata [16], Barros and Gomes [17], Petri nets make a simulation formalism with a graphical visualization and a determined syntax and semantics.

According to Murata [16], a Petri is defined as a two-partite oriented graph $N = \langle P, T, R \rangle$, where $P = \{P_i\}$ is a set of graph vertices which are places and $T = \{T_i\}$ is a set of vertices which are transitions. R component determines a relationship between the vertices corresponding to the arcs.

In a graphical representation of a Petri net, places (P) are indicated with circles, whereas transitions (T) are indicated with bars. According to the rules of Petri nets theory, vertices of the same type cannot be connected. In terms of real processes simulation, places usually

simulate various states (conditions) of the process, whereas the transitions imitate the events which happen within it.

The places can accept tokens which can move around the net via transitions. Disposition of tokens in places is determined by the marking set M which assigns an integer number to each place: $M = \langle M(p_1), \dots, M(p_i) \rangle$, where i is a number of places of the net, and $M(p_i)$ is the number of tokens in the place p_i . Thus, the amount of tokens and their disposition around the net control the net execution [16].

Various markings of the Petri net characterize the states of the corresponding dynamic system (process), and the dynamics of state changes is simulated by the movement of the tokens around places. Net marking may be changed as its transitions are triggered. When a transition is triggered, one token is deleted from each input place and is added to each output place.

The main facilities of Petri nets covered in a number of studies [16, 18], testify their advantages to be effectively used for modeling of parallel and consequent processes.

In the context of educational processes simulation, we would like to emphasize some essential Petri nets facilities which were used by the researchers in their works. In particular, the Petri nets were applied for courses structuring in e-learning platforms which allowed to build optimal learning paths for students [19, 20].

In addition, there were done the attempts to apply Petri nets simulation to synchronization in automatic measurement systems [18]; to model students' learning processes in e-learning [21, 22] etc.

The techniques used in said research also made the theoretical framework of our Petri nets-based approach to the modeling of synchronized curriculum.

3. Petri nets-based approach to the building of synchronized curriculum

Basing on the covered theoretical framework, let us focus on key issues, starting with the representation of the frames-based curriculum structure and its Petri nets-based modeling, and ending with the characterization of obtained model of curriculum.

In our approach, the disciplines are composed by the frames uniting the LEs and represented at the charts that specify the precedence between the LEs. As it is shown in figure 2 above, any frame has inputs and outputs. Inputs can be interpreted as the LEs necessary for the student to master in order to be able to learn the LEs of the frame. In similar way the outputs can be interpreted regarding the other frames.

We can distinguish different types of the precedence relations for the inputs:

- 1 LE to 1 LE relation: the only requirement of the LE's learning is the accomplishment of one previous LE's learning (within the frame or between the frames);
- 1 LE of K LEs of frame N to 1 LE of different frame M relation: a LE of the frame M has as requirement the accomplishment of learning of one of K LEs of previous frame N (OR precedence relation);
- The whole set of K LEs to 1: a LE of the frame M has as requirement the accomplishment of learning of the set of K LEs of previous frame N (AND precedence relation).

For the outputs, it is possible to set these kinds of relations:

- 1 LE to 1 LE relation: the LE is requirement to learning only one of the LE's learning (within the frame or between the frames);
- 1 LE to K LEs relation: the LE's learning is precedent to a set of K LE's learning.

Using these precedence relations, we can simulate LEs, frames (composed by the LEs) and curriculum disciplines (composed by the frames) through Petri nets.

Each LE can be represented with a common Petri net, and can be considered as the basic component to construct the discipline model. Petri net which simulates a LE mastering by the student is given in the figure 3.

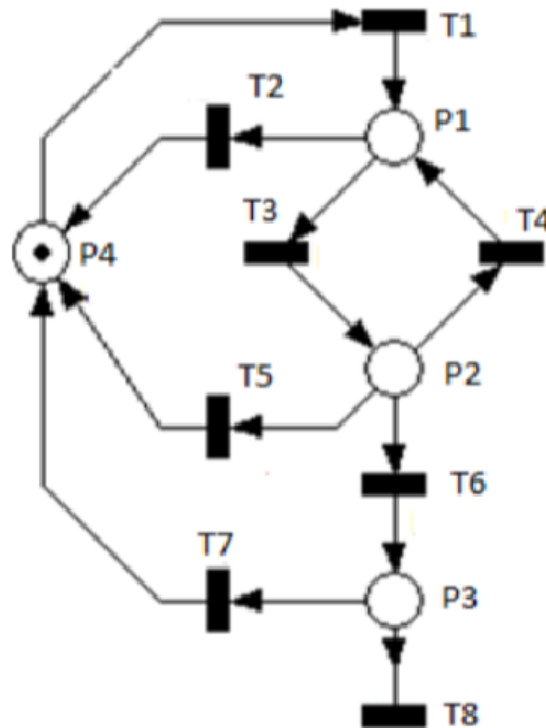

Figure 3: Petri net which simulates a LE mastering by the student.

The places **P1–P4** of the Petri net (figure 3) represent here the states of LEs as for their readiness to be learnt by students due to their precedence relations:

- the place **P1** represents the state that LE is ready (available) to be mastered by a student, according to its precedence relations;
- the place **P2** represents the state while the student is mastering of the LE;
- the place **P3** represents the accomplishment of the LE mastering;
- the place **P4** represents the state when the LE is unavailable student not being able to start the module.

The transitions **T1–T8** (figure 3) simulate the events of start of LE's mastering; the process of its learning, regarding the academic time and its availability due to its precedence relations; and accomplishing the LE's mastering.

There is always the only token in the net, which means that only one of the LEs states is true, so only one of the places can be marked at a time (in the situation shown in figure 3, it is in **P4**).

At the next step of modeling, such Petri nets which simulate a LE mastering were used to create a frame (course module) model. It was composed by a set of LEs' models connected, depending on their precedence relations determined above. This models (Petri nets) composition was done by merging transitions **T1** (LE is available to learn) of the dependent LE and **T8** (LE is ready to be continued) of the previous LE's model.

Figure 4, a – c demonstrates three situations of adding the LEs models to compose a frame (module) with regard to the said precedence relations:

- figure 4, a illustrates a 1 to 1 precedence relations where the fusion of the transition **T1** of the previous LE with the transition **T8** of the next LE is expected;
- figure 4, b presents a K to 1 precedence (AND precedence relation) where all the transitions **T8** of all previous modules and the transition **T1** of the next LE will be merged;
- figure 4, c demonstrates a 1 of K to 1 precedence (OR precedence relation) where each transition **T8** of each previous LE will be merged with the transition **T1** of the next LE.

Using the operations of Petri nets modifications (in particular, their fusion) defined in [17, 23] and LEs connections of different types (depicted above), we could obtain a model of a curriculum discipline module and finally – a curriculum discipline model.

These Petri nets models represent all the evolution of the LEs mastering by students in the curriculum courses. It is essential to note that output transitions of each LE's model can trig the subsequent LE's model only if the previous (in terms of precedence relation) one is accomplished. It is guaranteed by the rules of Petri net execution and modifications.

We would like to remind here that in our technique of curriculum building (depicted in figure 2) each discipline is represented by a frame with the nested other frames, which simulate the disciplines modules involving the LEs along with their connections.

Thus, summarizing our approaches to the university courses modeling based on the frames properties and Petri nets facilities, we would like to underline the following benefits in terms of applying such a simulation to the building of synchronized curriculum for IT-specialists training:

1. The built Petri nets allow to model the process of the LEs mastering by students in the frames (discipline modules) and between them.
2. Petri nets facilities provide grouping LEs into the frames (modules) taking into account precedence of their learning.
3. Facilities of frame-based model of knowledge representation provide spreading the set links between the LEs within the module and between the modules of different curriculum disciplines.

Thus, combining the applied properties of Petri nets modeling and AI models of knowledge representation allow to obtain both holistic and synchronized university curriculum.

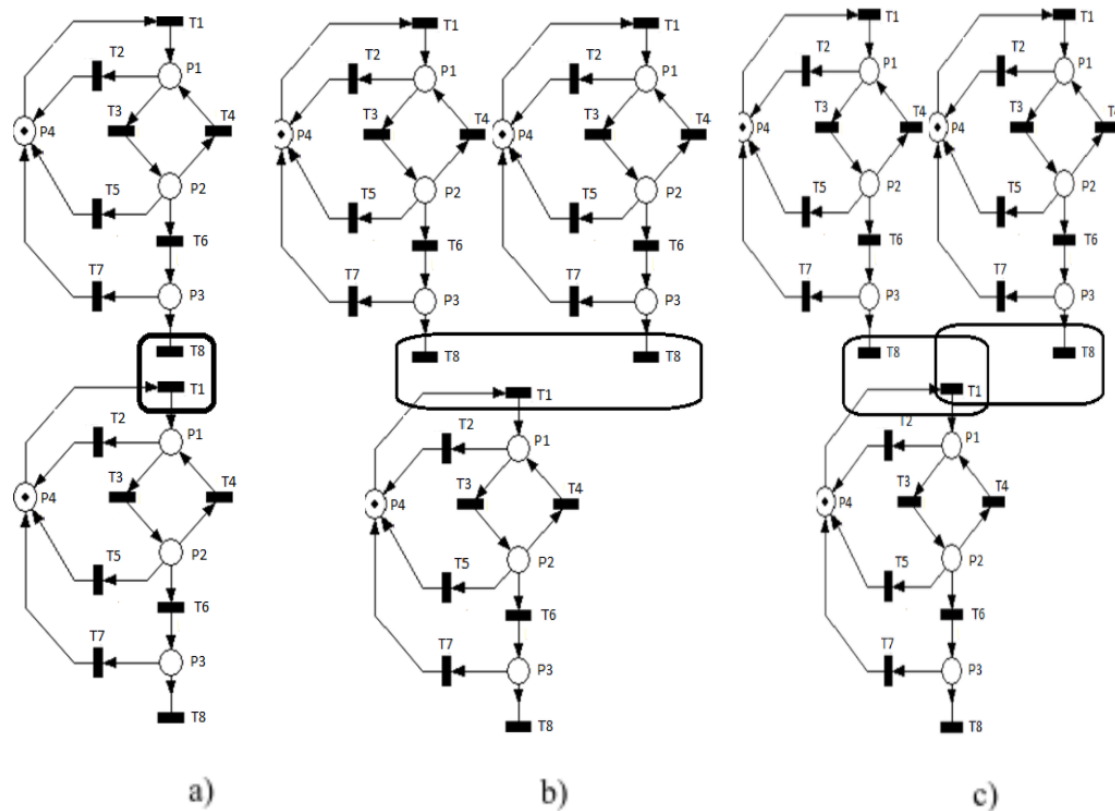

Figure 4: LEs connections, according to different types of precedence relations.

We would like to emphasize special importance of such modeling of curriculum exactly for pre-service IT-specialists' training. The built and realized model allows to shape the family of disciplines which are sensitive to the rapid changes in IT industry with immediate spreading of renewed requirements to the specialists in these sphere throughout all of the modules and with simultaneous preserving of the proper links. It is also provided the opportunity to mind the disciplines evolution and appearing new ones with their including into the flexible curriculum excluding the unnecessary repetition and academic time saving. The obtained curriculum with our simulation is flexible to account both global acceptance and national educational contexts. Thus, elaborated Petri nets-based mean for the curriculum simulation matches main guidelines for building contemporary computing curriculum.

Such an approach to the curriculum modeling can be used in the software for automatic creation of a holistic and synchronized curriculum, which makes prospects of our research. Such a software will allow:

- (1) to detect which proper LE and where has to be mastered;
- (2) to trace the LEs which have been mastered and will be necessary for mastering other set of LEs;
- (3) to build individual study plan for students etc.

4. Conclusions

The problems of synchronized curriculum shaping are discussed in the paper in the context of the challenges of contemporary IT specialists' training in terms of permanent evolution and rapid expansion of computing.

The authors' technique of the curriculum simulation based on Petri net applying is presented.

The theoretical framework which allowed us to elaborate the technique includes some didactical fundamentals of curriculum design and academic disciplines structuring as well as the theoretical basics of Petri nets in terms of their significant facilities for different processes synchronization. The technique of academic disciplines structuring based on frame model of knowledge representation is covered as a chain of stages which results in the net of disciplines modules (frames) including the proper learning elements along with preserving and spreading links between them.

In order to solve the problem of synchronization of the learning elements mastering throughout the academic disciplines with regard of the established links in the frames, it is offered the practically-driven approach to curriculum modeling based on Petri nets simulation.

The different types of the precedence relations for the learning elements (inputs and outputs of the frames) were distinguished. Using these precedence relations, we managed to simulate through Petri nets a learning element itself and the process of its mastering. Using the operations of Petri nets modifications and learning elements' connections of different types, we could obtain a model of a curriculum discipline module and finally – a curriculum discipline model.

Built Petri nets models represent all the evolution of the learning elements mastering by students in the curriculum courses. Synchronization of their mastering is guaranteed by the rules of Petri net execution and modifications.

The peculiarities of the offered technique are analyzed. The benefits in terms of applying such a simulation to the building of synchronized curriculum for IT-specialists training are formulated.

The prospects of the research are outlined in the lines of using the obtained results for special software development.

References

- [1] M. Ardis, D. Budgen, G. W. Hislop, J. Offutt, M. Sebern, W. Visser, SE 2014: Curriculum Guidelines for Undergraduate Degree Programs in Software Engineering, *Computer* 48 (2015) 106–109. URL: <https://doi.org/10.1109/MC.2015.345>. doi:10.1109/MC.2015.345.
- [2] Computer Engineering Curricula 2016: Curriculum Guidelines for Undergraduate Degree Programs in Computer Engineering, 2016. URL: <https://www.acm.org/binaries/content/assets/education/ce2016-final-report.pdf>.
- [3] Task Group on Information Technology Curricula, Information Technology Curricula 2017: Curriculum Guidelines for Baccalaureate Degree Programs in Information Technology, Association for Computing Machinery, New York, NY, USA, 2017.

- [4] Joint Task Force on Cybersecurity Education, *Cybersecurity Curricula 2017: Curriculum Guidelines for Post-Secondary Degree Programs in Cybersecurity*, Association for Computing Machinery, New York, NY, USA, 2018.
- [5] *Information Technology Transfer Curricula 2020: Curriculum Guidelines for Two-Year Transfer Programs in Information Technology*, 2020. URL: <https://ccecc.acm.org/files/publications/IT-Transfer2020.pdf>.
- [6] CC2020 Task Force, *Computing Curricula 2020: Paradigms for Global Computing Education*, Association for Computing Machinery, New York, NY, USA, 2020.
- [7] D. B. Clark, M. C. Linn, The knowledge integration perspective: Connections across research and education, in: S. Vosniadou (Ed.), *International Handbook of Research on Conceptual Change*, 2nd ed., Routledge, New York, 2013. doi:10.4324/9780203154472.
- [8] D. B. Clark, C. M. D'Angelo, S. P. Schleigh, Comparison of Students' Knowledge Structure Coherence and Understanding of Force in the Philippines, Turkey, China, Mexico, and the United States, *Journal of the Learning Sciences* 20 (2011) 207–261. doi:10.1080/10508406.2010.508028.
- [9] A. A. diSessa, N. M. Gillespie, J. B. Esterly, Coherence versus fragmentation in the development of the concept of force, *Cognitive Science* 28 (2004) 843–900. URL: https://onlinelibrary.wiley.com/doi/pdf/10.1207/s15516709cog2806_1.
- [10] M. Renzi, F. Sangiorgio, G. Carrada, A. Basset, Didactic of scientific disciplines in school: a possible role for LaguNet, *Transitional Waters Bulletin* 7 (2013). doi:10.1285/i1825229Xv7n2p13.
- [11] P. K. Singh, M. Kumar, A study on infrastructure and organizational learning: Rethinking knowledge performance perspective, *PEOPLE: International Journal of Social Sciences* 3 (2017) 61–77. URL: <https://grdspublishing.org/index.php/people/article/view/513>. doi:10.20319/pijss.2017.32.6177.
- [12] L. Gryzun, Integrative technology of academic subjects structuring and its applications to practical didactic issues, *Aktualni pytannia humanitarnykh nauk: mizhvuzivskyi zbirnyk naukovykh prats molodykh vchenykh Drohobytskoho derzhavnoho pedahohichnoho universytetu imeni Ivana Franka* 16 (2016) 309–315. URL: http://dspu.edu.ua/sites/youngsc/AQGS/2016_16/309-_%D0%93%D1%80%D0%B8%D0%B7%D1%83%D0%BD.pdf.
- [13] L. Gryzun, Integrative approach to the curriculum and content design for the pre-service teachers' training, *PEOPLE: International Journal of Social Sciences* 4 (2018) 1446–1462. URL: <https://grdspublishing.org/index.php/people/article/view/1572>. doi:10.20319/pijss.2018.42.14461462.
- [14] M. Minsky, A framework for representing knowledge, in: *Readings in Cognitive Science: A Perspective from Psychology and Artificial Intelligence*, 2013, pp. 156–289. doi:10.1016/B978-1-4832-1446-7.50018-2.
- [15] C. Ramirez (Ed.), *Advances in Knowledge Representation*, IntechOpen, 2012. URL: <https://www.intechopen.com/books/1932>. doi:10.5772/2351.
- [16] T. Murata, Petri nets: Properties, analysis and applications, *Proceedings of the IEEE* 77 (1989) 541–580. doi:10.1109/5.24143.
- [17] J. Barros, L. Gomes, Modifying Petri net models by means of crosscutting operations, in: *Third International Conference on Application of Concurrency to System Design*, 2003. *Proceedings*, 2003, pp. 177–186. doi:10.1109/CSD.2003.1207712.

- [18] P. Arpaia, M. L. Bernardi, G. Di Lucca, V. Inglese, G. Spiezia, An Aspect Oriented-based Architectural Framework for Synchronization in Measurement Systems, in: 16th IMEKO TC4 Symposium. Exploring New Frontiers of Instrumentation and Methods for Electrical and Electronic Measurements. Sept. 22-24, 2008, Florence, Italy, 2008. URL: https://www.academia.edu/21866608/An_aspect_oriented_based_architectural_framework_for_synchronization_in_measurement_systems.
- [19] R. Campos-Rebelo, A. Costa, L. Gomes, Finding Learning Paths Using Petri Nets Modeling Applicable to E-Learning Platforms, in: L. M. Camarinha-Matos, E. Shahamatnia, G. Nunes (Eds.), Technological Innovation for Value Creation, Springer Berlin Heidelberg, Berlin, Heidelberg, 2012, pp. 151–160. doi:10.1007/978-3-642-28255-3_17.
- [20] D. C. Borges, H. B. Neto, J. N. de Souza, Work in progress – Petri Nets as applied to the modeling of E-learning cooperative systems, in: 2010 IEEE Frontiers in Education Conference (FIE), 2010, pp. F1D-1–F1D-3. doi:10.1109/FIE.2010.5673186.
- [21] M. Kuchárik, Z. Balogh, Student learning simulation process with petri nets, in: S. Patnaik, V. Jain (Eds.), Recent Developments in Intelligent Computing, Communication and Devices, Springer Singapore, Singapore, 2019, pp. 1115–1124. doi:10.1007/978-981-10-8944-2_130.
- [22] T. V. Shestakevych, V. V. Pasichnyk, The use of Petri Nets for inclusive education IT-support, ECONTECHMOD : An International Quarterly Journal on Economics of Technology and Modelling Processes 4 (2015) 33–38. URL: <https://yadda.icm.edu.pl/yadda/element/bwmeta1.element.baztech-f4c8f26a-c76f-471c-8563-ca39a54ae112>.
- [23] J. Barros, L. Gomes, Net model composition and modification by net operations: a pragmatic approach, in: 2nd IEEE International Conference on Industrial Informatics, 2004. INDIN '04. 2004, 2004, pp. 309–314. doi:10.1109/INDIN.2004.1417350.

The algorithm for knowledge assessment based on the Rusch model

Alexander A. Kostikov¹, Kateryna V. Vlasenko^{2,3}, Iryna V. Lovianova⁴,
Sergii V. Volkov⁵ and Evgeny O. Avramov¹

¹Donbass State Engineering Academy, 72 Academichna Str., Kramatorsk, 84313, Ukraine

²National University of "Kyiv Mohyla Academy", 2 Hryhoriya Skovorody Str., Kyiv, 04655, Ukraine

³Technical University "Metinvest Polytechnic" LLC, 71A Sechenov Str., Mariupol, 87524, Ukraine

⁴Kryvyi Rih State Pedagogical University, 54 Gagarin Ave., Kryvyi Rih, 50086, Ukraine

⁵The Institute of Chemical Technologies of the East Ukrainian Volodymyr Dahl National University, 31 Volodymyrska Str., Rubizhne, 93009, Ukraine

Abstract

In this paper the algorithm for adaptive testing of students' knowledge in distance learning and an assessment of its effectiveness in the educational process has been proposed. The paper provides an overview of the results of the application of modern test theory, a description and block diagram of the proposed algorithm and the results of its application in the real educational process. The effectiveness of using this algorithm for the objective assessment of students' knowledge has been experimentally shown.

Keywords

adaptive algorithm, Rasch model, Item Response Theory (IRT), information function of test item, latent variables

1. Introduction

1.1. Problem statement

Modern approaches to assessing students' academic achievements are based on the use of classical testing theory and Item Response Theory (IRT). The mathematical background of pedagogical measurement theory was created by Andersen [1, 2], Andrich [3], Avanesov [4], Birnbaum [5], Guttman [6], Linacre [7], Lord et al. [8], Maslak et al. [9], Masters [10], Rasch

CoSinE 2021: 9th Illia O. Tepytskyi Workshop on Computer Simulation in Education,

co-located with the 17th International Conference on ICT in Education, Research, and Industrial Applications: Integration, Harmonization, and Knowledge Transfer (ICTERI 2021), October 1, 2021, Kherson, Ukraine

✉ alexkst63@gmail.com (A. A. Kostikov); vlasenkov@ukr.net (K. V. Vlasenko); liriha22@gmail.com

(I. V. Lovianova); sergei.volkov@ukr.net (S. V. Volkov); avramzenek@gmail.com (E. O. Avramov)

🌐 http://www.dgma.donetsk.ua/index.php?option=com_content&Itemid=635&id=3686&lang=uk&layout=edit&view=article (A. A. Kostikov); <http://formathematics.com/uk/tyutori/vlasenko/> (K. V. Vlasenko);

<https://kdpu.edu.ua/personal/ilovianova.html> (I. V. Lovianova); <http://formathematics.com/uk/tyutori/sergij-volkov/> (S. V. Volkov)

🆔 0000-0003-3503-4836 (A. A. Kostikov); 0000-0002-8920-5680 (K. V. Vlasenko); 0000-0003-3186-2837

(I. V. Lovianova); 0000-0001-7938-3080 (S. V. Volkov); 0000-0002-8405-7164 (E. O. Avramov)

© 2022 Copyright for this paper by its authors.

Use permitted under Creative Commons License Attribution 4.0 International (CC BY 4.0).



CEUR Workshop Proceedings (CEUR-WS.org)

[11] and other scientists. In IRT, the concept of a latent variable is used. The term “latent variable (parameter)” is usually understood as a theoretical concept that characterizes a certain hidden property or quality (for example, the level of students’ ability, the difficulty of the test task), which cannot be directly measured. The advantages of the classical testing theory are the provision of information about the indicators of the knowledge quality of the subjects, the clarity of the performed calculations and the simple interpretation of the processing data. The main disadvantage is the dependence of the results of evaluating the participants’ parameters on the difficulty of the proposed tasks. Application of IRT, based on Rush’s models, provides the possibility of the evaluation independence of the latent parameter “ability level” calculated values of participants θ_i from the values of the “item difficulty” β_i . This helps to increase the objectivity of the obtained assessments of the students’ ability level and allows to build effective algorithms for assessing knowledge.

The *purpose* of this paper is to develop an algorithm of adaptive testing for objective assessment of students’ knowledge in distance learning, which becomes especially relevant in the quarantine of COVID-19.

1.2. State of arts and review

The educational standards of the new generation are based on a competency-based approach to assessing the quality of a student’s training, when it is not his knowledge that is tested, first of all, but his readiness to apply it in practice and to act productively in a non-standard situation, the ability to create the required mode of action. Therefore, the quality of training is understood as the degree of the student’s readiness to demonstrate the relevant competencies.

The generalization of the world experience in the implementation of the competence-based approach to assessing learning outcomes allows us to make the following conclusions that determine the main approaches to assessing the level of competence mastery, the main of which are the following:

- competencies are dynamic, since they are not an invariable quality in the structure of a pupil’s personality, but are able to develop, improve or completely disappear in the absence of an incentive to manifest them. Therefore, we can talk about the level of competence, assess it quantitatively, and monitor it.
- when assessing learning outcomes, it is necessary to consider them in dynamics, which requires diagnostics of the educational process using monitoring procedures.
- the level of possession of a competence is a hidden (latent) parameter of the pupil and direct measurement is not amenable. It can be estimated with a certain probability. Therefore, when evaluating it, a probabilistic approach should be used.

It follows from this that in order to create tools for the automated assessment of the learning outcomes, it is necessary, first of all, to solve two problems:

- 1) develop theoretical and methodological foundations for modeling and parameterization of the learning process and the diagnostic tools used to evaluate its results;
- 2) theoretically substantiate and implement software-algorithmic means for processing the results of participants’ diagnostics (testing, questionnaires), as well as tools for assessing learning outcomes and the quality of diagnostic tools.

The theoretical and methodological basis for solving these problems was the study results, first of all, by Brown [12], Cronbach [13], Guilford [14], Gulliksen [15], Guttman [6], Kuder and Richardson [16], Luce and Tukey [17], Lord et al. [8], Sax [18], Spearman [19]. They developed the theoretical foundations for the creation of diagnostic materials and the classical approach to processing, analysis and interpretation of diagnostic results: the conceptual apparatus of the classical test theory, criteria and indicators of the quality of diagnostic tools, methodological basics of their design and quality expertise. The issues of scaling and comparison of processing data have been deeply investigated.

The theoretical basis for the creation of tools for automatic assessment of the results of the educational process has received its further development due to the creation of the IRT (Item Response Theory), the foundations of which are set out by Andrich [3, 20], Bezruczko [21], Bond and Fox [22], Bond et al. [23], Eckes [24], Fischer and Molenaar [25], Andrich et al. [26], Ingebo [27], Kim and Baker [28], Lazarsfeld [29], van der Linden and Hambleton [30], Lord [31], Luce and Tukey [17], Perline et al. [32], Smith and Smith [33], Rasch [11], Wilson [34], Wright [35], Wright and Masters [36], Wright and Stone [37], Wright and Linacre [38].

2. Algorithm of adaptive testing based on Rasch model

Adaptive testing is a type of testing in which the order of presentation of test items and the difficulty of the next task depends on the participant's answers to previous items. The basis of adaptive testing systems are statistical models. Very easy and very difficult tasks are automatically uninformative. Therefore, for most tests, the optimal level of difficulty is the item, to which the correct answer is given by about half of the test participants.

The difficulties of the test items is determined experimentally, and the measurement process consists of determining the percentage of participants who are able to give the correct answer to the task in previous experiments.

The problem of developing adaptive algorithms has been considered by Al-A'ali [39], Weiss [40, 41].

The Rush model was used to construct the adaptive testing algorithm. This model is defined by formulas:

$$P_{ni} = \frac{\exp(\theta_n - \beta_i)}{1 + \exp(\theta_n - \beta_i)} \quad (1)$$

where P_{ni} is the probability that the participant n , $n = 1, \dots, N$ with the ability θ_n correctly performs the task i , $i = 1, \dots, I$, with the difficulty β_i . To start the algorithm it is necessary to determine the initial levels of difficulties. To this end, at the beginning of the testing session the accumulation of primary information about the level of preparation of the participant is carried out. To do this, participant receive N_p tasks with an average level of difficulty. Tasks to determine the initial level of the participant are chosen by the teacher. Then, using the received answers, the initial estimation of the ability level of the student is calculated, and also recalculation of the difficulty level current values of test items is carried out.

The initial assessment of the ability level of the i -th student (in logs) is based on the formula:

$$\theta_i^0 = \ln \left(\frac{p_i}{q_i} \right), \quad i = 1, 2 \dots N, \quad (2)$$

where N is the number of test participants, p_i is the proportion of correct answers of the i -th participant to all tasks, q_i is the proportion of incorrect answers ($q_i = 1 - p_i$).

The difficulty level of test items in logs is determined by the formula:

$$\beta_j^0 = \ln \left(\frac{q_j}{p_j} \right), \quad j = 1, 2 \dots M, \quad (3)$$

where M is the number of test items, p_j is the proportion of correct answers of all participants to the j -th test item, q_j is the proportion of incorrect answers.

At the next stage, the initial values in the logs of the ability level of participants θ_i^0 and the initial values in the logs of the difficulty level of the test item β_j^0 are reduced to a same interval scale [8]. The formula for such transition is based on the idea of reducing the impact of the items difficulty on the assessments of test participants.

Pre-calculating the average value of the initial logits of the students' ability level

$$\bar{\theta} = \frac{\sum_{i=1}^N \theta_i^0}{N}$$

and the standard deviation V of the initial values distribution of the parameter θ

$$V^2 = \frac{\sum_{i=1}^N (\theta_i^0 - \bar{\theta})^2}{N - 1},$$

we obtain a formula for calculating the difficulty level logit of the j -th item

$$\beta_j = \bar{\theta} + Y \cdot \beta_j^0, \quad j = \overline{1, M}, \quad (4)$$

where

$$Y = \sqrt{1 + \frac{V^2}{2.89}}$$

Similarly, calculating

$$\bar{\beta} = \frac{\sum_{j=1}^M \beta_j^0}{M}, \quad W = \sqrt{\frac{\sum_j^M (\beta_j^0 - \bar{\beta})^2}{M - 1}}$$

we get the formula for calculating the ability level logit of the i -th student:

$$\theta_i = \bar{\beta} + X \cdot \theta_i^0, \quad i = \overline{1, N}, \quad (5)$$

where $X = \left(1 + \frac{W^2}{2.89}\right)^{\frac{1}{2}}$.

The obtained values allow to compare the level of students' ability with the level of test item difficulty. If $\theta_i - \beta_j$ is a negative quantity and is large in modulus, then the problem of difficulty β_j is too difficult for a student with the ability level θ_i , and it will not be useful for measuring the level of knowledge of the i -th student. If this difference is positive and large in

modulus, then the task is too easy, it has long been mastered by the student. If $\theta_i = \beta_j$, then the probability that the student correctly completes the task is equal to 0.5.

The information function of the i -th problem for the Rush model (1) $I_i(\theta)$ is defined as the product of the probability of the correct answer $P_i(\theta)$ to this problem on the probability of the incorrect answer $Q_i(\theta)$ [8]

$$I_i(\theta) = P_i(\theta) \cdot Q_i(\theta) \quad (6)$$

Figure 1 shows the information function of the i -th item.

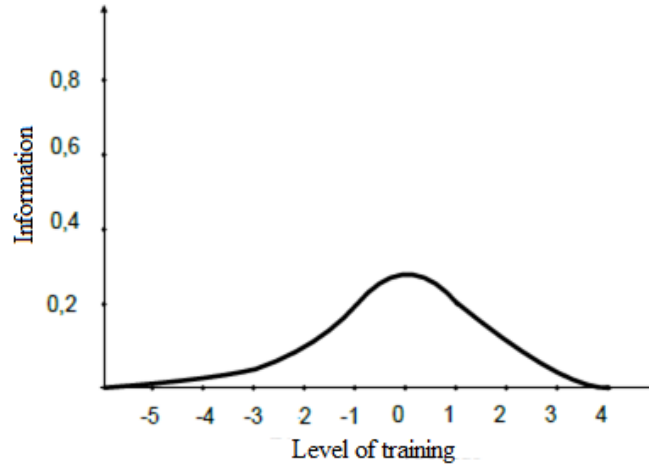

Figure 1: Information function of the test task.

Figure 1 shows that the test item, the answer to which all students know, does not provide any information, as well as the item, the answer to which no one knows. We get useful information when some participants know the answer to the task and some do not.

The information function of the test is calculated as the sum of the information functions of the test items [8]:

$$I(\theta) = D^2 \cdot \sum_{j=1}^M I_j(\theta) \quad (7)$$

where D is the correction factor ($D = 1.7$), necessary to approximate the distribution of logistic probability to the law of normal distribution.

After calculating the information function, the measurement error SE is calculated, the value of which is used to check the condition of the end of the test procedure. In the Rusch model, the measurement error depends on the level of training θ and is calculated by the formula [8]:

$$SE(\theta) = \frac{1}{\sqrt{I(\theta)}} \quad (8)$$

If the error takes a value less than the threshold set by the teacher, the adaptive testing algorithm ends. Otherwise, the following test task is selected. To select the next task, use the value of θ_i , calculated by formula (5). The next task is the one whose difficulty level is

closest to the current assessment of the ability level of the participant. This task has the largest information contribution and its choice reduces the total number of required test tasks.

Thus, the developed adaptive testing algorithm consists of the following stages:

1. Selection of 5 tasks of average difficulty from the bank of questions, which is determined by the teacher.
2. Finding the initial level of student's ability θ_i^0 and the initial difficulty level of items β_j^0 by formulas (2) and (3).
3. Reduction of the obtained initial values θ_i^0 and β_j^0 to a single interval scale using formulas (5) and (4).
4. Calculation of the information function of test tasks to which the student answered by formulas (6) and (7).
5. Finding the measurement error by the formula (8).
6. If the measurement error is less than the threshold, the adaptive testing is completed.
7. If not, then the next task is selected from the condition $|\theta_i - \beta_j| = \min$.
8. Then the algorithm is repeated starting from point 3.

The block diagram of the algorithm is shown in figure 2.

3. Results

Let us consider the procedure for calculating the parameters of student ability level θ_i and item difficulty parameter β_i from empirical data. As initial data we will take results of testing of students in Moodle system on discipline "Higher Mathematics" of the Mathematics and Modeling Department of the Donbass State Engineering Academy (Table 1). Table 1 shows the records of the first 10 test participants. A total of 50 participants took part in the testing.

Table 1

Test results in the Moodle system in the discipline "Higher Mathematics" of the Mathematics and Modeling Department of the Donbass State Engineering Academy

Participant's number	Score	Number of correct answers	p_i	q_i	θ_i^0
1	90	18	0.9	0.1	2.197225
2	75	15	0.75	0.25	1.098612
3	85	17	0.85	0.15	1.734601
4	100	20	1	0	∞
5	75	15	0.75	0.25	1.098612
6	100	20	1	0	∞
7	90	18	0.9	0.1	2.197225
8	90	18	0.9	0.1	2.197225
9	70	14	0.7	0.3	0.847298
10	85	17	0.85	0.15	1.734601

The test in this discipline consisted of 20 questions. First, it is necessary to calculate the proportions of correct p_i and incorrect q_i answers of participants. These values are calculated

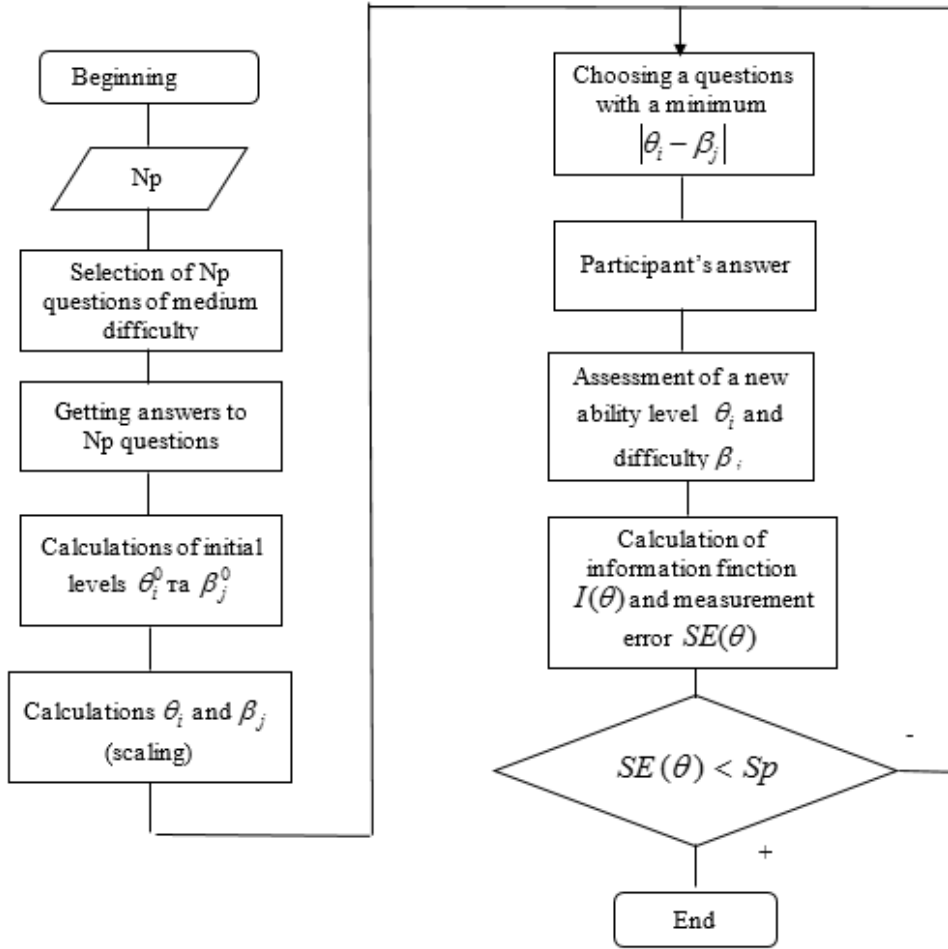

Figure 2: Block diagram of the adaptive testing algorithm.

by formulas

$$p_i = \frac{R_i}{N}, q_i = 1 - p_i, \quad (9)$$

where R_i is the number of correct answers for the i -th test item, $i = 1, 2, \dots, n$, and n is the number of items in the test.

For example, for the first participant of testing we have

$$p_1 = \frac{18}{20} = 0.9, q_1 = 1 - 0.9 = 0.1$$

The values p_i and q_i are given in columns 3 and 4 of table 1.

Next, calculate the initial values θ_1^0 of the ability level of participants by formula (2). For the first participant we have

$$\theta_1^0 = \ln \frac{0.9}{0.1} = 2.197$$

Using the statistical module Moodle, the following characteristics were obtained for test tasks: facility index(F), standard deviation (SD), random guess score (RGS), intended weight, effective weight, distinction, distinction efficiency. These data are shown in table 2.

Table 2

Statistical characteristics obtained using the statistical module of the Moodle system based on the results of final testing in the discipline “Higher Mathematics”

Q#	F	SD	RGS	Intended weight	Effective weight	Distinction	Distinguishing efficiency
1	98.00%	14.14%	33.33%	5.00%		-11.54%	-28.62%
2	94.00%	23.99%	33.33%	5.00%	3.41%	6.93%	11.28%
3	90.00%	30.30%	16.67%	5.00%	6.75%	44.07%	65.85%
4	94.00%	23.99%	20.00%	5.00%	4.66%	22.91%	39.11%
5	96.00%	19.79%	20.00%	5.00%	3.34%	11.72%	23.66%
6	90.00%	30.30%	14.29%	5.00%	3.18%	-1.53%	-2.22%
7	92.00%	27.40%	14.29%	5.00%	6.32%	43.38%	70.79%
8	84.00%	37.03%	20.00%	5.00%	6.48%	26.08%	35.44%
9	88.00%	32.83%	20.00%	5.00%	5.32%	17.26%	23.76%
10	74.00%	44.31%	20.00%	5.00%	9.75%	68.31%	84.84%
11	98.00%	14.14%	20.00%	5.00%	2.85%	14.64%	35.69%
12	100.00%	0.00%	16.67%	5.00%	0.00%		
13	94.00%	23.99%	33.33%	5.00%	4.93%	27.00%	45.87%
14	90.00%	30.30%	33.33%	5.00%	5.51%	23.81%	34.88%
15	88.00%	32.83%	25.00%	5.00%	5.32%	17.26%	23.76%
16	90.00%	30.30%	33.33%	5.00%	5.51%	23.81%	33.33%
17	42.00%	49.86%	20.00%	5.00%	5.23%	-2.60%	-3.57%
18	80.00%	40.41%	33.33%	5.00%	8.11%	45.46%	56.25%
19	56.00%	50.14%	20.00%	5.00%	7.01%	13.80%	17.23%
20	82.00%	38.81%	20.00%	5.00%	6.32%	21.10%	27.68%

Based on the data in table 2, we can estimate the initial values of the item difficulty parameter. By formula (3) for the first problem we obtain

$$\beta_1^0 = \ln \frac{2}{98} = -3.891$$

The results of calculations of the initial values of the item difficulty parameter are given in table 3.

As can be seen from table 3, all participants in the quiz answered the 12th item, so the score was equal to infinity with a minus sign. But practically at $\beta > -6$ the probability value $P_i(\beta)$ close to one. These items are performed by all participants and they become redundant. Items with $\beta > 6$ are also useless. Such items will not be overcome by any participant and they do not carry any information about differences in the students' ability levels.

In tables 1 and 3, the parameter values θ_i^0 and β_i^0 are on different interval scales. In order to reduce them to a single scale of standard estimates, it is necessary to calculate the variances V^2 and W^2 using the data from tables 1 and 3. Infinite data are excluded from consideration.

Table 3
Initial values β_i^0 of the item difficulty parameter

Q#	Progress	p_i	q_i	β_i^0
1	98.00%	0.98	0.02	-3.89182
2	94.00%	0.94	0.06	-2.75154
3	90.00%	0.90	0.10	-2.19722
4	94.00%	0.94	0.06	-2.75154
5	96.00%	0.96	0.04	-3.17805
6	90.00%	0.90	0.10	-2.19722
7	92.00%	0.92	0.08	-2.44235
8	84.00%	0.84	0.16	-1.65823
9	88.00%	0.88	0.12	-1.99243
10	74.00%	0.74	0.26	-1.04597
11	98.00%	0.98	0.02	-3.89182
12	100.00%	1.00	0.00	$-\infty$
13	94.00%	0.94	0.06	-2.75154
14	90.00%	0.90	0.10	-2.19722
15	88.00%	0.88	0.12	-1.99243
16	90.00%	0.90	0.10	-2.19722
17	42.00%	0.42	0.58	0.322773
18	80.00%	0.80	0.20	-1.38629
19	56.00%	0.56	0.44	-0.24116
20	82.00%	0.82	0.18	-1.51635

Calculating the variance, we obtain

$$V^2 = \frac{\sum_{i=1}^N (\theta_i^0 - \bar{\theta})^2}{N - 1} = 0.634,$$

$$W^2 = \frac{\sum_j^M (\beta_j^0 - \bar{\beta})^2}{M - 1} = 4.873$$

Next, we calculate the angular coefficients [8]:

$$Y = \sqrt{1 + \frac{V^2}{2.89}} = 1.104$$

$$X = \sqrt{1 + \frac{W^2}{2.89}} = 1.63$$

Next on the formulas

$$\theta_i = -2.103 + 1.104\theta_i^0$$

$$\beta_i = 1.86 + 1.63\beta_i^0$$

calculate the scaled values β_i and θ_i .

In tables 4 and 5 scaled parameter values are provided.

Table 4Scaled values of item difficulty parameter β_i

Q#	β_i^0	β_i
1	-3.89182	-4.48367
2	-2.75154	-2.625
3	-2.19722	-1.72148
4	-2.75154	-2,625
5	-3.17805	-3.32023
6	-2.19722	-1.72148
7	-2.44235	-2.12103
8	-1.65823	-0.84291
9	-1.99243	-1.38766
10	-1.04597	0.155071
11	-3.89182	-4.48367
13	-2.75154	-2,625
14	-2.19722	-1.72148
15	-1.99243	-1.38766
16	-2.19722	-1.72148
17	0.322773	2.386121
18	-1.38629	-0.39966
19	-0.24116	1.466906
20	-1.51635	-0.61165

Table 5Scaled values of the ability level θ_i

Participant's number	θ_i^0	θ_i
1	2.197225	0.322736
2	1.098612	-0.89013
3	1.734601	-0.188
5	1.098612	-0.89013
7	2.197225	0.322736
8	2.197225	0.322736
9	0.847298	-1.16758
10	1,734601	-0.188

The sum of the scaled difficulty levels of test items is -27.93.

This means that the test items are very easy. This test is not balanced, it contains a lot of easy items. It is necessary to strive to ensure that this amount is close to zero. Thus, the assessment of latent parameters allows to determine noninformative items that should be excluded from the quiz. The use of the developed adaptive algorithm will allow to objectively assess the level of students' knowledge.

The graph of the information function of test items and the test as a whole, defined by formulas (6) and (7), is shown in figure 3.

Figure 3 shows that the information function has one clearly expressed maximum. This is a

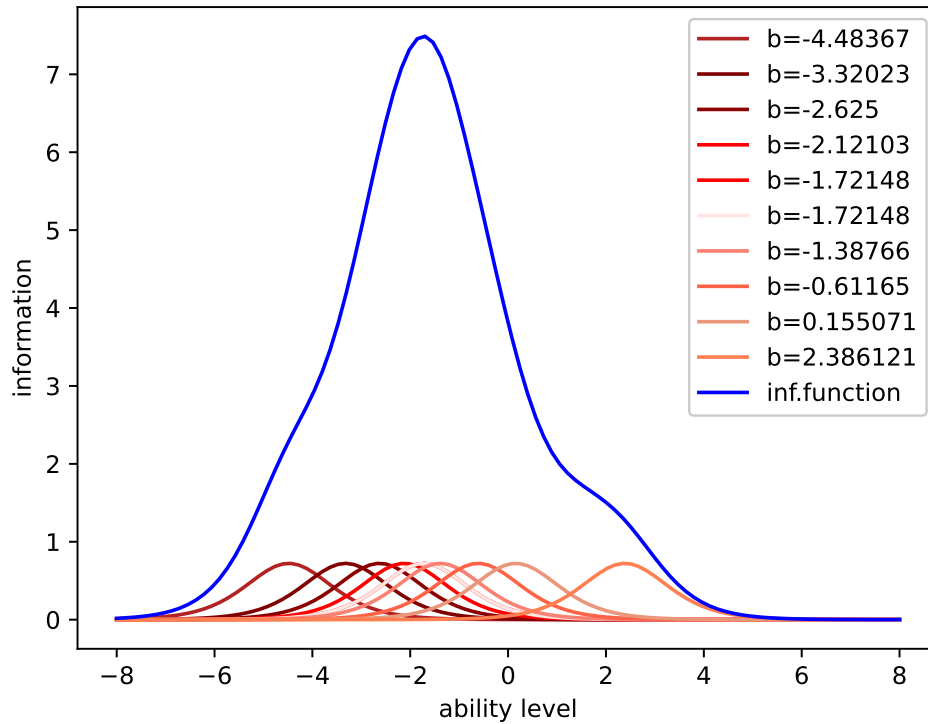

Figure 3: Information functions of the test and test items.

sign of a “good” test. However, it can be seen that the test contains a lot of easy test items with difficulties in the interval (-3; -2), which can be excluded from the test. Also in the test there are many easy tasks with the same difficulties, which can also be excluded from the test without violation of its information content. However, the more difficult tasks (with difficulties of 1-2 logits) are clearly not enough in the test, so it is necessary to add more complex tasks.

The graph of the measurement error, depending on the level of training, is shown in figure 4.

It can be seen from the graph that the measurement error is large for the values of the ability in the interval (2,4), which is associated with the lack of test items of increased difficulty.

4. Discussion

The purpose of this paper was to automate the process of testing students’ knowledge, which is especially relevant for distance learning. To achieve this goal, an adaptive testing algorithm based on the Rush model was proposed and the modeling of the students’ knowledge assessment process using this algorithm was carried out. The results of testing their knowledge in the course “Higher Mathematics” obtained in the Moodle system were taken as the initial values of the tasks complexity and the levels of the students’ ability.

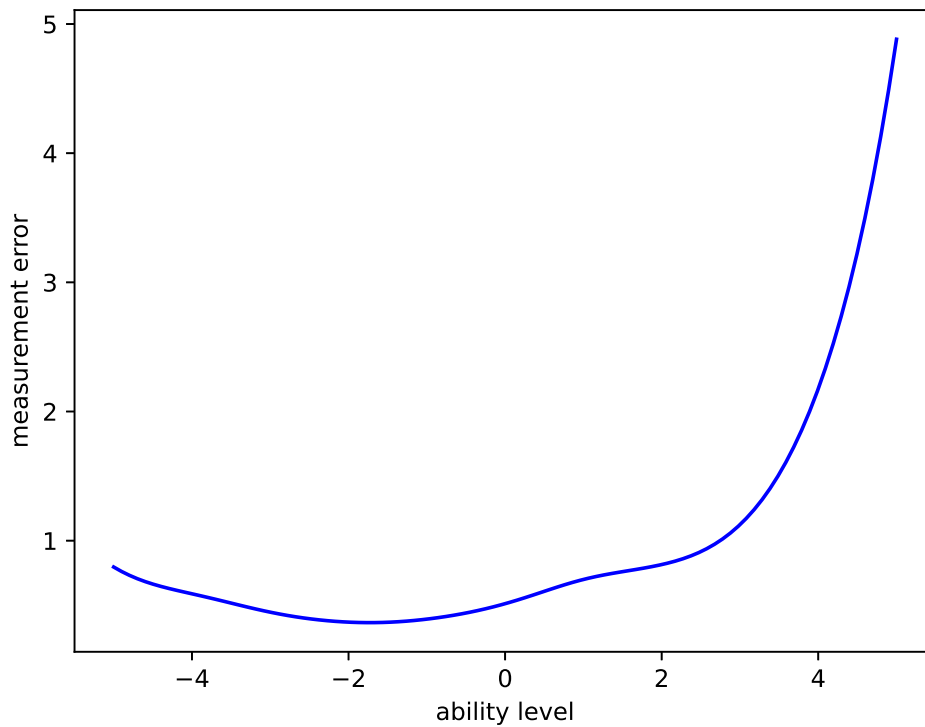

Figure 4: Measurement error graph.

As a result of modeling, the levels of students' abilities were recalculated, the information functions of the test tasks and the entire test as a whole were built, the standard measurement error was calculated, depending on the student's ability level. The analysis of the obtained results allows us to conclude that the test is not balanced, contains too many easy tasks. In this case, these are tasks with numbers 1, 3, 11. Removing them from the test will reduce the number of test items and speed up the process of determining the student's level of training. A change in the assessment of the student's ability level as a result of testing indicates the need to introduce an adaptive testing system into the educational process, which will improve the quality of assessment of student knowledge.

These conclusions are confirmed by the works of other authors. So, Al-A'ali [39] shown that the use of adaptive testing based on IRT made it possible to reduce the number of test tasks and increase the reliability of determining the level of student readiness. The effectiveness of the use of adaptive testing to improve the quality of pedagogical measurements is evidenced by Weiss [40, 41].

5. Conclusions

As a result of this work, the following results were obtained:

1. An algorithm of adaptive knowledge assessment based on the IRT approaches was proposed. This algorithm consists of an initial assessment of the difficulty level of test items and students' abilities, scaling of these parameters, selection of the next question based on minimizing the module of their difference and estimation of the measuring error of the knowledge level by the information function of the proposed question.
2. The test parameters were evaluated on the basis of IRT theory, which identified non-informative test questions that should be excluded from the set of test items.

The results of the study showed the effectiveness of using IRT to assess knowledge.

References

- [1] E. B. Andersen, The asymptotic distribution of conditional likelihood ratio tests, *Journal of the American Statistical Association* 66 (1971) 630–633. doi:10.1080/01621459.1971.10482321.
- [2] E. B. Andersen, A goodness of fit test for the Rasch model, *Psychometrika* 38 (1973) 123–140. doi:10.1007/BF02291180.
- [3] D. Andrich, *Rasch Models for Measurement*, Thousand Oaks, 2021. URL: <https://methods.sagepub.com/book/rasch-models-for-measurement>. doi:10.4135/9781412985598.
- [4] V. S. Avanesov, The problem of psychological tests, *Soviet Education* 22 (1980) 6–23. doi:10.2753/RES1060-939322066.
- [5] A. Birnbaum, Combining independent tests of significance*, *Journal of the American Statistical Association* 49 (1954) 559–574. doi:10.1080/01621459.1954.10483521.
- [6] L. Guttman, A basis for scaling qualitative data, *American Sociological Review* 9 (1944) 139–150. doi:10.2307/2086306.
- [7] J. M. Linacre, Predicting responses from Rasch measures, *Journal of Applied Measurement* 11 (2010) 1–10.
- [8] F. M. Lord, M. R. Novick, A. Birnbaum, *Statistical theories of mental test scores*, Addison-Wesley, Oxford, 1968.
- [9] A. A. Maslak, G. Karabatsos, T. S. Anisimova, S. A. Osipov, Measuring and comparing higher education quality between countries worldwide, *Journal of Applied Measurement* 6 (2005) 432–442.
- [10] G. N. Masters, Educational measurement: Prospects for research and innovation, *The Australian Educational Researcher* 15 (1988) 23–34. doi:10.1007/BF03219425.
- [11] G. Rasch, *Studies in mathematical psychology: I. Probabilistic models for some intelligence and attainment tests*, Nielsen & Lydiche, 1960.
- [12] W. Brown, Some experimental results in the correlation of mental abilities¹, *British Journal of Psychology*, 1904-1920 3 (1910) 296–322. doi:10.1111/j.2044-8295.1910.tb00207.x.
- [13] L. J. Cronbach, Coefficient alpha and the internal structure of tests, *Psychometrika* 16 (1951) 297–334. doi:10.1007/BF02310555.

- [14] J. P. Guilford, *Fundamental statistics in psychology and education*, McGraw-Hill, New York, 1942.
- [15] H. Gulliksen, Perspective on Educational Measurement, *Applied Psychological Measurement* 10 (1986) 109–132. doi:10.1177/014662168601000201.
- [16] G. F. Kuder, M. W. Richardson, The theory of the estimation of test reliability, *Psychometrika* 2 (1937) 151–160. doi:10.1007/BF02288391.
- [17] R. D. Luce, J. W. Tukey, Simultaneous conjoint measurement: A new type of fundamental measurement, *Journal of Mathematical Psychology* 1 (1964) 1–27. doi:10.1016/0022-2496(64)90015-X.
- [18] G. Sax, *Principles of educational and psychological measurement and evaluation*, 3rd ed., Wadsworth Pub. Co., Belmont, 1989.
- [19] C. Spearman, Correlation calculated from faulty data, *British Journal of Psychology*, 1904-1920 3 (1910) 271–295. doi:10.1111/j.2044-8295.1910.tb00206.x.
- [20] D. Andrich, The Rasch model explained, in: *Applied Rasch measurement: A book of exemplars*, Springer, 2005, pp. 27–59.
- [21] N. Bezruczko (Ed.), *Rasch measurement in health sciences*, Jam Press Maple Grove, MN, 2005.
- [22] T. Bond, C. Fox, *Applying the Rasch model: Fundamental measurement in the human sciences*, second ed., 2007. doi:10.4324/9781410614575.
- [23] T. Bond, Z. Yan, M. Heene, *Applying the Rasch model: Fundamental measurement in the human sciences*, fourth ed., Routledge, 2020.
- [24] T. Eckes, *Introduction to Many-Facet Rasch Measurement*, Peter Lang, Bern, Switzerland, 2011. URL: <https://www.peterlang.com/view/title/13347>.
- [25] G. H. Fischer, I. W. Molenaar (Eds.), *Rasch models: Foundations, recent developments, and applications*, Springer Science & Business Media, 1995. doi:10.1007/978-1-4612-4230-7.
- [26] D. Andrich, B. Sheridan, G. Luo, Rumm2010: Rasch unidimensional measurement models, 2001. URL: <http://www.rummlab.com.au/>.
- [27] G. S. Ingebo, *Probability in the Measure of Achievement*, Mesa Press, 1997.
- [28] S.-H. Kim, F. B. Baker, birtr: A Package for “The Basics of Item Response Theory Using R”, *Applied Psychological Measurement* 42 (2018) 403–404. doi:10.1177/0146621617748327.
- [29] P. F. Lazarsfeld, Regression analysis with dichotomous attributes, *Social Science Research* 1 (1972) 25–34. doi:10.1016/0049-089X(72)90056-7.
- [30] W. J. van der Linden, R. K. Hambleton (Eds.), *Handbook of Modern Item Response Theory*, Springer Science & Business Media, 1997. doi:10.1007/978-1-4757-2691-6.
- [31] F. M. Lord, *Applications of Item Response Theory To Practical Testing Problems*, Routledge, 1980. doi:10.4324/9780203056615.
- [32] R. Perline, B. D. Wright, H. Wainer, The Rasch model as additive conjoint measurement, *Applied Psychological Measurement* 3 (1979) 237–255. doi:10.1177/014662167900300213.
- [33] E. V. Smith, R. M. Smith (Eds.), *Introduction to Rasch measurement: Theory, models and applications*, JAM Press, 2004.
- [34] M. Wilson, *Constructing Measures: An Item Response Modeling Approach*, Routledge,

2005.

- [35] B. D. Wright, Solving Measurement Problems with the Rasch Model, *Journal of Educational Measurement* 14 (1977) 97–116. URL: <http://www.jstor.org/stable/1434010>.
- [36] B. D. Wright, G. N. Masters, *Rating scale analysis*, Mesa Press, Chicago, 1982.
- [37] B. D. Wright, M. H. Stone, *Best test design*, Mesa Press, Chicago, 1979. URL: [https://www.rasch.org/BTD_RSA/pdf%20\[reduced%20size\]/Best%20Test%20Design.pdf](https://www.rasch.org/BTD_RSA/pdf%20[reduced%20size]/Best%20Test%20Design.pdf).
- [38] B. D. Wright, J. M. Linacre, Dichotomous rasch model derived from specific objectivity, *Rasch measurement transactions* 1 (1987) 5–6. URL: <https://www.rasch.org/rmt/rmt11a.htm>.
- [39] M. Al-A'ali, IRT-Item Response Theory Assessment for an Adaptive Teaching Assessment System, in: *Proceedings of the 10th WSEAS International Conference on APPLIED MATHEMATICS, MATH'06*, World Scientific and Engineering Academy and Society (WSEAS), Stevens Point, Wisconsin, USA, 2006, p. 518–522.
- [40] D. J. Weiss, Improving measurement quality and efficiency with adaptive testing, *Applied Psychological Measurement* 6 (1982) 473–492. doi:10.1177/014662168200600408.
- [41] D. J. Weiss, Computerized adaptive testing for effective and efficient measurement in counseling and education, *Measurement and Evaluation in Counseling and Development* 37 (2004) 70–84. doi:10.1080/07481756.2004.11909751.

Ontology-based learning environment model of scientific studies

Roman A. Tarasenko¹, Stanislav A. Usenko¹, Yevhenii B. Shapovalov¹, Viktor B. Shapovalov¹, Adrian Paschke² and Iryna M. Savchenko¹

¹The National Center “Junior Academy of Sciences of Ukraine”, 38-44 Degtyarivska Str., Kyiv, 04119, Ukraine

²Fraunhofer FOKUS (with support of BMBF “Qurator” 03WKDA1F), Kaiserin-Augusta-Allee 31, 10589 Berlin, Germany

Abstract

Nowadays, there is a wide variety of scientific articles. Due to this fact, it is hard to read and be familiar with all of them. Also, it is hard for a young scientist to understand the complicated terms and methods that are used in a specific research domain. This problem was partially solved by bibliographic management software and other specific software. This article is devoted to the development of an approach for structuration and processing sets of studies using the IT Platform Polyhedron using an ontology-based hierarchical model. In its structure, the ontological graph is complex because it has additional branches from child nodes. The basis of our solution was IMRAD which has been represented in the view of nodes. Those nodes have been connected with specific representations of IMRAD elements. Specific articles have been represented in the view of leaf nodes. That could help to use the taxonomies for the structuration of the articles. Each data block is in the form of separate attributes of the ontological node. The proposed solution allows to obtain structured sets of studies and to separate their characteristics. Thus, the proposed ontology provides the possibility to view all methods, measured parameters, etc. of the studies in a graph node structure and use them to find the studies where they were used.

Keywords

cognitive IT-platform Polyhedron, ontology, ontological tool, scientific studies, scientific reports, learning environments

1. Introduction

Usage of information technologies (IT) in various fields of research activities and the capability of software support in science to automatically classify and structure information, e.g.,

CoSinE 2021: 9th Illia O. Teplytskyi Workshop on Computer Simulation in Education, co-located with the 17th International Conference on ICT in Education, Research, and Industrial Applications: Integration, Harmonization, and Knowledge Transfer (ICTERI 2021), October 1, 2021, Kherson, Ukraine

✉ tarasenko@man.gov.ua (R. A. Tarasenko); sjb@man.gov.ua (Y. B. Shapovalov); svb@man.gov.ua (V. B. Shapovalov); paschke@inf.fu-berlin.de (A. Paschke); SavchenkoI@nas.gov.ua (I. M. Savchenko)

🌐 <https://www.scopus.com/authid/detail.uri?authorId=57211134149> (R. A. Tarasenko);

<https://www.scopus.com/authid/detail.uri?authorId=57224619975> (S. A. Usenko);

<http://www.nas.gov.ua/EN/PersonalSite/Pages/default.aspx?PersonID=0000026333> (Y. B. Shapovalov);

<https://www.nas.gov.ua/EN/PersonalSite/Pages/default.aspx?PersonID=0000029045> (V. B. Shapovalov);

<https://dblp.org/pid/24/2942.html> (A. Paschke);

<https://www.nas.gov.ua/EN/PersonalSite/Statuses/Pages/default.aspx?PersonID=0000020650> (I. M. Savchenko)

🆔 0000-0001-5834-5069 (R. A. Tarasenko); 0000-0002-0440-928X (S. A. Usenko); 0000-0003-3732-9486

(Y. B. Shapovalov); 0000-0001-6315-649X (V. B. Shapovalov); 0000-0003-3156-9040 (A. Paschke); 0000-0002-0273-9496

(I. M. Savchenko)

© 2022 Copyright for this paper by its authors.
Use permitted under Creative Commons License Attribution 4.0 International (CC BY 4.0).



CEUR Workshop Proceedings (CEUR-WS.org)

in publication data, becomes increasingly important. Nowadays, there are huge amounts of research data available that isn't structured, e.g., publications, presentations, etc. It is complicated for young researchers and scientists to use such large amounts of publication data. During the research process, young scientists are looking for, e.g., examples of research methods and parameters. However, this task is challenging at their early stage of the scientific career. Such literature search and analysis problems (e.g. state of art analysis) are challenging for every scientist (including youth, school researchers) during the process of preparing papers and reports. For instance, according to Lens.org, the number of articles on biogas in 2002 was approximately 134, then in 2014, the number grew up to almost 1164, as shown in figure 1.

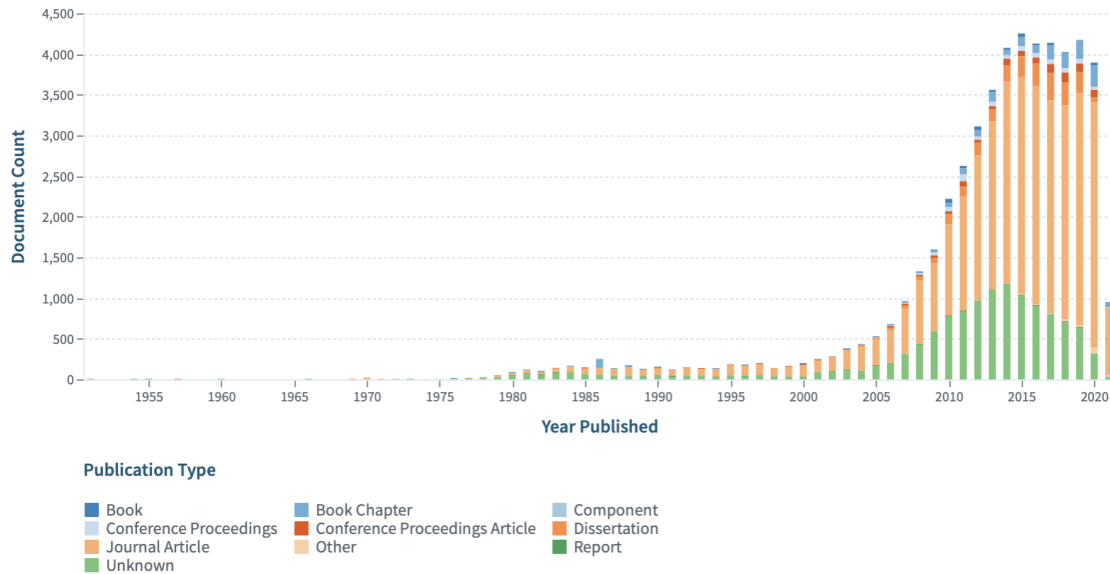

Figure 1: Dynamic of the number of the papers on biogas.

So, it seems relevant to provide a solution that can simplify processing and information/knowledge extraction in scientific publications. There are two hypotheses in our study. The first one is about structuring and digitalization of the data, which can simplify finding the details about the research method. The second one is about structuring the results of previous studies, which can be represented as data of the informational system. Previously, this goal was partially achieved using metadata for data processing. In this paper we further contribute with a semantic ontology and more expressive semantic metadata approach.

1.1. Using metadata to provide data management in science publications

To support publication data management, it is relevant to use metadata about each paper. This metadata represents the data about the publication. In this case, relevant information about each specific publication can be represented by the metadata. Metadata can include, e.g., contact information, year of publication, author details, instrument and protocol information, survey tool details and much more [1].

For instance, reference management software maintains a database of articles and creates bibliographies and reference lists for the written works. This software simplifies the record of metadata. There are several popular reference management software, for example, Refworks, Mendeley, EndNote and Zotero [2, 3, 4, 5]. All of these managers can save profiles, build a database of citations, save PDF files and extract metadata from them, import references from library catalogues, websites, and other citation managers [6, 7, 8].

However, these systems only use limited metadata vocabularies without expressive semantic models. For instance, such systems do not support metadata concepts such as “Results”, “Materials and methods”, “References” etc. All these systems do not provide a systematic approach, they are not completely semantically structured and not hierarchical.

1.2. Methods for automatic literature review processing

There are existing different types of metadata information that we can use to structure the articles, for example, by the relation to source, by the function, by the purpose, by the language, by the time:

- By the “Relation to Source”: During this method, the user defines the type of text that can be included in a classification program. A classification that is composed of extracts having exact sentences of a source document is known as an extractive summary. That is the simplest type of classifier.
- By the “Function”: with this method, user can use any helpful and relevant information from source documents, for example, an abstract of a scientific article or the reviewers’ opinion on the quality of work.
- By the “Purpose”: This method structures the article by its purpose or main idea. The user needs to write down the general-purpose or sense of the text in the program by himself.
- By the “Language”: A classifier can be monolingual or multilingual. The monolingual classifier uses only one language and produces an output classification in the same language as the input document whereas, the multilingual classifier uses multiple languages and gives an output classification in one of the languages from the input document.
- By the “Time”: It is possible to arrange the articles by the time of their publication. To do so, the user must enter the publication date of the article in the system, then the system will arrange the article in an appropriate section.

In our opinion, there is a lack of methods that we can use for the structurization of scientific articles. Also, it is necessary to add “By the Results” and “By the methods” methods.

- “By the Results” this method structures the article by its results or conclusions. The user needs to write down the outcomes or verdicts of the text in the program by himself.
- “By the Methods” this method structures the article by the scientific methods or experiments that are used in the essay.

Considering that most of the articles have a typical IMRAD (Introductions, Methods, Results, Abstract, Discussion) structure, it seems advisable to build an algorithm that uses data of many specific articles to create ontological graphs, that can be integrated in specialized educational environments for young scientists.

1.3. Instruments for creation of ontology-based learning environments

A learning environment is a diverse platform where users engage and interact to learn new skills. While learners can learn in various settings, the term typically refers to a digital alternative for the traditional classroom. To improve learning efficiency and adaptability, formalized information resources that provide a high degree of structuring should be used in learning. An ontological approach could support this. The ontological approach provides a holistic and systematic approach to the study of various information sources and a specific subject domain, ensures the conceptualization and taxonomization of terms within the subject area and the existence of relationships between the terms of different subject areas to ensure multidisciplinary. Computer ontologies are one of the effective mechanisms for ensuring a stable digital learning environment.

In recent years significant progress was made in developing ontologies. In this article, an “ontology” is a term that means a software or web system that consists of nodes with data. All ontology nodes are arranged in a specific hierarchical order, often referred to as an ontological tree or ontological graph. The node from which all branches start is called the root node. The other nodes are called subsidiaries.

One of the most perspective solution, in our opinion, is ontologies [9]. For example, we can use hierarchies with multicriteria techniques during the classification of metadata of various articles. Ontologies aim to capture the domain knowledge in a general way and ensure a common understanding of the domain.

IsaViz is a virtual environment for viewing and creating RDF models in the view graphs. IsaViz imports RDF/XML and N-Triples, and exports RDF/XML. Apollo is the program for modelling knowledge systems. Apollo knowledge system base consists of hierarchically organized ontologies that can be inherited from other ontologies. SWOOP contains OWL (Web Ontology Language) validation and offers various. OWL presentation syntax views. At SWOOP, Ontologies can be compared, edited, and combined. Protégé 3.5 is a knowledge-based ontology editor that provides a graphical user interface. It ensures better flexibility for metamodelling, enables the construction of domain ontologies.

1.4. Ontological problems

Nowadays most of the common systems (such as Mendeley, Scopus etc.) provide support for displaying of data but not for comparison and providing search functions. Also, given that articles in the same domain have the same indicators, the metadata of the results can be represented as ontology node attributes and then processed.

Previously, ontological graphs were used to systematize scientific articles [9, 10, 11, 12, 13]. Systematization and structuring in such ontological systems were based on different approaches such as using of scientific article recommendation system [10], a scientific articles tagging system [11], machine learning and automatic summarization [9]. None of the proposed ontological approaches [9, 10, 11, 12] can't provide a decent level of structurization and systematisation.

We have proposed to use the cognitive IT platform Polyhedron [14] for this aim. The core of the Polyhedron system consists of advanced and improved functions of the TODOS IT platform [14] described in previous works. The Polyhedron is a multiagent system that

provides transdisciplinary and interactivity in any study [15]. Besides, cognitive IT-platform Polyhedron contains a different variety of special functions like auditing [15, 16, 17], semantic web, information systematization and ranking [18] transdisciplinary support [19], internal search [20], and have all advantages of ontological interface tools [16, 21]. Due to active states are hyperratio plural partial ordering [19, 22], cognitive IT-platform Polyhedron is an innovative IT technology of ontological management of knowledge and information resources, regardless of the standards of their creation.

The proposed solution can be used with other applications in the field of structuration studies like a virtual educational experiment, provide STEM approach in education [14, 23], using the technology of augmented reality education [24, 25], educational and scientific environments [14, 20].

2. Materials and methods

2.1. Ontology creation mechanism

The proposed research is based on approach that was proposed before [26], but it provides management and structuring of set of the studies, not single. To create ontologies in cognitive IT-platform Polyhedron, Google Sheets are used to collect and structure the information (see example in figure 2). The sheets with study report data (structure file and numeric/semantic data file) are downloaded and saved in .xls format. The data was separated with expert involving and based on principle that researches of same field have similar input and resulting characteristics. Same is relevant to field of anaerobic digestion [27, 28] that was taken as example to provide structuring and processing using proposed method. The files are loaded to editor.stemua.science to provide graph generation (a part of the cognitive IT platform Polyhedron). After that, the generation of the graph nodes (in .xls) with its characteristics using structure file is carried out. The obtained graphs are saved in .xml format and located in the database. The graphs are filled by semantic and numeric information for ranking or filtering. Ontological nodes are formed using predicate equations.

2.2. Description of the works were used to demonstrate the structuration mechanism

To demonstrate the structuring of the educational study reports, a master thesis of the National University of Food technologies “Development a method for utilization of anaerobic digestion effluent at LLC Vasylykivska Poultry Farm” (in further – report “A”) and a study report prepared for the defence of an educational study in the Junior academy of sciences of Ukraine scientific competition “Development a method for utilization of anaerobic digestion effluent” (in further – report “B”) are used as input data. Two ontologies have been built, the structure of which duplicates the content of the study reports. All numeric data was separated to provide information processing and to provide integration between those works. Their titles have used as the parent node for the ontological graphs. All ontological graphs in the cognitive IT platform Polyhedron have been linked to each other by the mechanism of internal search. Further scientific studies will be linked in the graphs by edges (links) to provide better connection.

	A	B	C	D	E	F	G	H	I
1	Scientific reports	Reports on biotechnology							
2	Reports on biotechnology	Reports on anaerobic digestion							
3	Reports on anaerobic digestion	Main Metadata	Materials and methods	References	Results				
4	Results	Final results	Input parameters of the research						
5	Materials and methods	Materials for researching	Methods for Quantitative Analysis						
6	References	Використання хлорелі в сільському господарстві: дис. докт. біол. наук/ Куліщенко Ю.Л., Мельник І.А., Новиков О.М., 2011.	Водорості та гриби; навч. пос. / Костіков І.Ю., Джаган В.В. та ін., 2004	Екологічна безпека при виробництві продукції птахівництва: дис. докт. біол. наук / Тертична О. В., 2007.	Оценка биомассы Spirulina Platensis (Nordst.) по оптической плотности культуры: дис. докт. биол. наук / Геворгиз Р. Г., 2003.	Ростовые и биохимические характеристики Spirulina Platensis и Chlorella vulgaris при различных условиях минерального питания : дис. докт. / Дробецька И. В., 2001.	Bioconversion of Poultry Droppings for Biogas and Algal Production: дис. докт. біол. наук/ M. Mahadevaswamy, L. V. Venkataraman, 2013.	Removal of nitrate and phosphate from municipal wastewater sludge by Chlorella Vulgaris, Spirulina Platensis and Scenedesmus Quadricauda: дис. докт. біол. наук/ Jalal K.S., Kamaruzzaman B.Y, Akbar J.	
7	Main Metadata	Object of research	Subject of research	The aim of the research	Practical value of research	Scientific novelty of research	Hypothesis	Keywords	
8	Input parameters of the research	Temperature mode	Moisture content of substrate	Substrate					
9	Materials for researching	Glassware for chemistry lab	Gauze-cotton plugs	Chlorella vulgaris	MES (Mineral Nutrient Environment)	Chicken manure	Spectrophotometer	Effluent from methane tank (fertilizer) from JSC	

Figure 2: Google sheet with data.

2.3. Ranking tools

Study reports “A” and “B” were also compared with each other by the following criteria: “Short-term economic perspective”, “Long-term economic prospects” using the ranking tool. For creation of the ranking ontologies have been used by the module “Alternative” which is described in previous works [18, 29]. The nodes of the graph have been filled with semantic data grouped in semantic classes. The ranking uses grade scale from one to ten point to underline the importance coefficient.

2.4. Auditing tools

To provide an audit, the “standard” graph (with which the comparison is done) and the “comparison” graph (which is compared with the “standard”) have been created. The “standard” ontology graph contains the data on hypotheses, subjects, objects of study, keywords, and other parameters, of the studies reports done before. For the “standard” graph, each parameter was presented in a separate node. The content of this ontological graph “standard” is updated and supplemented constantly.

The nodes of the “comparison” graph have been presented with the names of the works which need to be audited with the “standard” graph. The parameters of the work used to audit with the “standard” graph have been located in the metadata of each separate node. The metadata type names were identical to the names of the nodes of “standard” graph to provide interaction between graphs.

3. Results

3.1. Model of creation ontology to systemizing

As was noted before, IMRAD is widely used to prepare research and science papers. It is possible to provide structuration by the usage of IMRAD components as parent nodes. So, the parent nodes can be represented by Introduction, Methods, Results and Discussion. The discussion part can't be easily structured by an ontology. The most contractionary part that it contains are the analysis and the comparison of the obtained data by the researcher. Specific parts of IMRAD will be used as branch nodes, and the study will be used as a leaf node. So, the general structure of the ontology that structures the research data is represented as:

$$REP \in \{I, M, R, P\} \quad (1)$$

where REP – set of reports, I – sets of Introduction of all study, M – set of Methods of all study, R – set of Results of All study, P – instruments of processing of the results of set of studies discussions.

To provide better systematization we have split the introduction into two different parts – basic metadata and literature review:

$$I = \langle BMD, LR \rangle \quad (2)$$

where BMD – is a set of basic metadata of study, LR – a set of Sources used for Literature Review.

The basic metadata node of the study is linked with the graph's leaf nodes that characterized basic data on the study such as hypothesis, object, subject, practical value, and scientific novelty, etc. So, the nodes of the report's basic metadata of the study can be presented as a further equation:

$$BMD = \langle H, O, S, PV, SN \rangle \quad (3)$$

where H – hypothesis or hypotheses of each specific study; O – object of the study of each specific study; S – subject of the of each specific study; PV – practical value of each specific study; SN – scientific novelty of each specific study.

The main advantages of using such a structure are that some parts of the introduction materials and methods and results (measured parameters) of study (reports) can coincide. A few specific studies that coincide will be linked by nodes (in case of methods and results) or by classes of data (in case of keywords or scientific novelty) due to using the same subnodes of the ontology. Let's represent each work as a set of the Introduction, Methods, Results, and Processing of the data (Discussion):

$$REP_I = \langle I_I, M_I, R_I, P_I \rangle \quad (4)$$

$$REP_{II} = \langle I_{II}, M_{II}, R_{II}, P_{II} \rangle \quad (5)$$

So, these studies can be integrated in a single ontology using IMRAD:

$$O = \langle S_I, S_{II} \rangle = \langle I_I, M_I, R_I, P_I, I_{II}, M_{II}, R_{II}, P_{II} \rangle \quad (6)$$

The same approach will be applied to each element of the IMRAD structure study. Generally, it can be represented as:

$$M = (REP_i) = \sum_i^n M_I \quad (7)$$

where M_i – every separated scientific method.

In a different study, a different set of methods can be used. However, some of them can coincide. Thus, set of methods used in two different study may be represented as:

$$M = (REP_I) = \{M_a, M_b, M_c, M_d\} \quad (8)$$

$$M = (REP_{II}) = \{M_b, M_d, M_f\} \quad (9)$$

And, so, M_b coinciding to both M_I and M_{II} :

$$M_b \in \{M_I, M_{II}\} \quad (10)$$

Therefore, in this case, and M_b can be used as a parent node that connects two different studies. The node M_b itself will contain general theoretic information on it, and node REP_I and REP_{II} will contain information on the specific case of its usage and measured parameters using it.

Similar mechanism can be provided by using specific ontology tools using metadata. For example, there will be a hierarchical approach for representing and usage of keywords:

$$Kw(BMD_i) = \text{Class "Keywords" Type "Array Value"} \{Kw_a, Kw_b, Kw_c, Kw_d\}, \quad (11)$$

where $Kw(BMD_i)$ – node of the basic metadata that integrates all keywords; Kw_i – specific keyword.

Also, as was noted in the introduction, the metadata of each work will be used for filtering the information, and for supporting specific processing functions of the IT solution Polyhedron. Such specifics mechanisms are AUDIT and RANKING. Metadata can be included in each node. For the parent node metadata will be used to represent the general information (for example, essence of the method itself), and the resulting leaf node will contain the specific metadata related to specific study (such as specific results of the study obtained using set methods M; for example, metadata: 5.35, and its class: "Ammonium nitrogen content, g/L"). So, metadata, with the same class, will be processed by using filtering by users request or by ranking using the ranks of the nodes for specific classes (or their set) based on the user's request.

So, the proposed approach uses IMRAD to collect and process the data with ontologies. In this way, the ontologies are constructed not by the specific structure of each work but by the generally accepted IMRAD structure. The parent node will be a specific area set to which the study belongs ($A = \sum_i^n REP_{Ii}$, where A – specific area of set of REP). The A node is linked with I, M, R, P nodes (representing IMRAD). Each IMRAD node is linked with the specific IMRAD type node (such as ammonia determination by Nessler's method (for methods) or "chicken manure" or "glycerine" (for subjects)). And each specific IMRAD type node is linked with leaf nodes of ontology – specific studies where such entities were used.

3.2. Structuring several works simultaneously using an ontological graph

To demonstrate the capabilities of the proposed ontological system, scientific works on anaerobic digestion were chosen. The general view of the resulting graph is shown in figure 3.

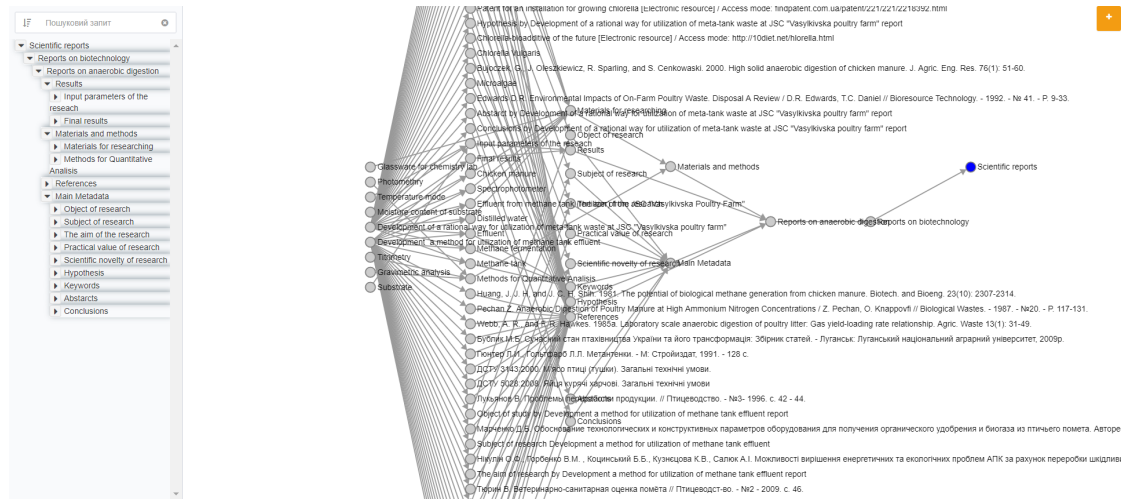

Figure 3: General view of the resulting ontological graph.

The root node of the resulting graph is the “Scientific reports” node. In its structure, the ontological graph is complex because it has additional branches from child nodes. Child nodes are: “Reports on biotechnology” and “Reports on anaerobic digestion.” From the child node “Reports on anaerobic digestion” are going the central sub-leaf nodes that reflect the basic principle of systematization of scientific works: “Results,” “Materials and methods,” “References”. This basic principle is shown in figure 4. A separate node of Main Metadata was also additionally created. This node contains the central metadata: object, subject of study; practical significance, the scientific novelty of study; hypotheses; keywords; abstract, conclusions.



Figure 4: General view of the main systematizing ontological vertices.

The entire sequence and principle of filling and maintenance of data by users in the received ontology are shown in the Workflow diagram (figure 5).

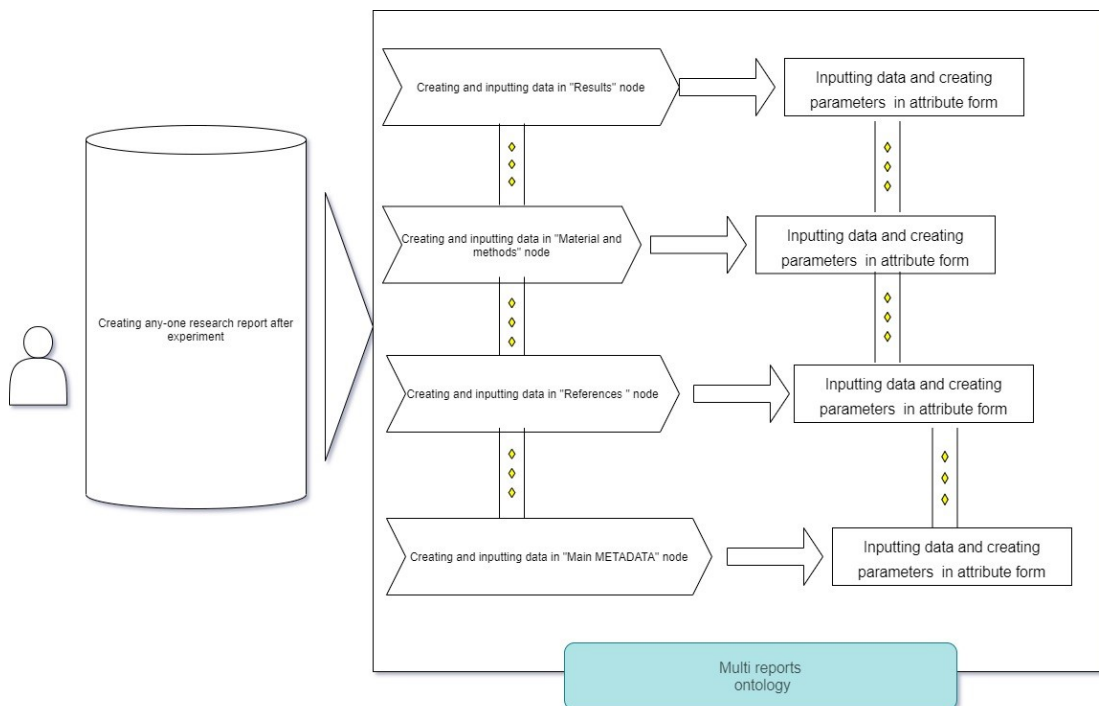

Figure 5: Workflow diagram of filling and maintenance of data by users.

The child nodes of each of these systematizing ontological nodes are the scientific works themselves. Each data block is in the form of separate attributes of the ontological node. This solution allows you to use all the information processing tools of the CIT Polyhedron system. In particular, such tools are both general (for example, filtering) and specialized, such as ranking and auditing. An example of filtering is shown in figure 6.

3.3. Application of ranking mechanism in the structuring of scientific works

All attributes can be used to rank information using the “Alternative module” described in previous works [18, 29]. Each nodes attributes is filled with numeric, textual, and/or mixed types of data. The following attributes are filled with text data: “References”, “Methods for Quantitative Analysis”, “Materials for researching”, “Thermophilic”, “Chicken manure substrate”, “Spectrophotometer parameters of the experiment”, “The actual rate of reproduction of”, “Keywords”, “Glassware”, “Reagents”, “Equipment”, “Object”, “Subject of study”, “The aim of the study”, “Chicken”. Numeric data contains the following attributes: “Initial pH”, “Methane content, % Vol.”, “pH of obtained solid product”, “Ammonium nitrogen concentration, mg/L”, “The concentration of volatile fatty acids (VFA) mg/L”, “The dry matter content, %”, “The ash content, %”. The attribute “The native moisture content of the substrate” contains mixed-type

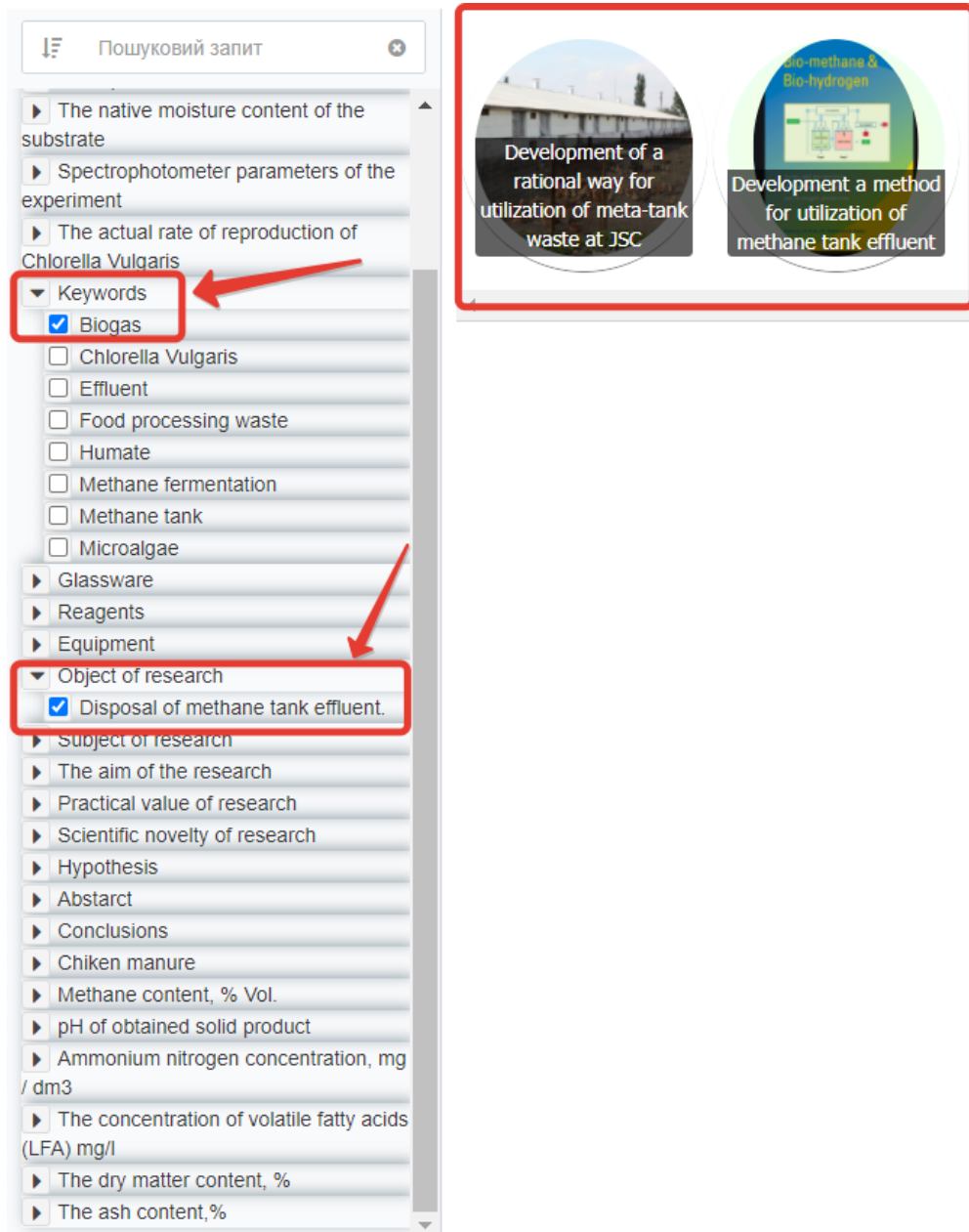

Figure 6: Example of attribute filter.

data, numeric and textual. An example of an incoming data maintenance panel for ranking is shown in figure 7.

For example, there may be a case when user wants to arrange work on the pH. The ranking result is shown in figure 8. Other examples of usage of the Polyhedron IT platform are shown in table 1.

Назва критерію	Більша шкала	Лінгвістична шкала	Ранжування	Opt. 2
References	1	Мала важкість	1	max
Methods for Quantitative Analysis	1	Мала важкість	1	max
Materials for research	1	Мала важкість	1	max
Thermophilic	1	Мала важкість	1	max
Chicken manure substrate	1	Мала важкість	1	max
Initial pH	1	Абсолютна важкість	1	max
The native moisture content of the substrate	1	Мала важкість	1	max
Spectrophotometer parameters of the equipment	1	Мала важкість	1	max
The actual rate of reproduction of Clostridia Vulgaria	1	Мала важкість	1	max
Keywords	1	Мала важкість	1	max
Glossary	1	Мала важкість	1	max
Reagents	1	Мала важкість	1	max
Equipment	1	Мала важкість	1	max
Object of research	1	Мала важкість	1	max
Subject of research	1	Мала важкість	1	max
The aim of the research	1	Мала важкість	1	max
Chicken manure	1	Мала важкість	1	max
Methane content, % Vol	1	Мала важкість	1	max
pH of obtained solid product	1	Мала важкість	1	max
Ammonium nitrogen concentration, mg / dm³	1	Мала важкість	1	max
The concentration of volatile fatty acids (LFA) mg/l	1	Мала важкість	1	max
The dry matter content, %	1	Мала важкість	1	max
The ash content, %	1	Мала важкість	1	max

Figure 7: Example of a water panel for data ranking.

Peirair	Keywords	Methods for Quantitative Analysis	Materials for researching	Equipment	Reagents	Thermophilic	Chicken manure substrate	Initial pH	The native moisture content of the substrate	Glassware	Chicken manure	Spectrophotometer parameters of the experiment	The actual rate of reproduction of Clostridia Vulgaria	Object of research	Subject of research	The aim of the research	Practical value of research	Scientific novelty of research	
Development of a method for utilization of methane tank effluent	Food processing waste Biogas Effluent	Analysis of ammonium nitrogen content with Nessler's reagent	Chicken manure Spectrophotometer Effluent from methane tank JSC "Varykivskia Pivnyy Farm"	Spectrophotometer Crucible (or similar porcelain or metal dishes) Muffled furnace	Distilled water Nessler's reagent HPO4	The list of scientific reports where was used as this temperature mode for anaerobic	The list of scientific reports where was used as the substrate for	73.9	250 ml volumetric flask List of works have used the substrate with not	250 ml volumetric flask Conical flask (Erlenmeyer) for 200 ml Pipette ear 1 200 ml	List of works which have used chicken manure as the substrate for methane fermentation	Spectrophotometer parameters from the 1st to the 6th day of the experiment	Rate of reproduction of Clostridia Vulgaria	Disposal of methane tank effluent	Processing of methane tank effluent into humate by the autolysis method	To establish regularities of processing methane tank effluent into humate by the autolysis method	The study indicates the possibility of obtaining salts of humic and tannic acids by the method of methane fermentation	1. Potassium humate was first obtained from methane tank	
Development of a rational way for utilization of media tank waste at JSC "Varykivskia pivnyy farm"	Methane Biogas Chlorella Vulgaria Effluent	Analysis of ammonium nitrogen content with Nessler's reagent	Effluent from methane tank (fertilizer from JSC "Varykivskia Pivnyy Farm") Spectrophotometer	Electronic scales Crucible (or similar porcelain or metal dishes) Muffled furnace Electronic scales	HPO4 Phenolphthalein	The list of scientific reports where was used as this temperature mode for anaerobic	The list of scientific reports where was used as the substrate for	8.2	List of works have used the substrate with not	Conical flask (Erlenmeyer) for 200 ml Pipette ear 1				Cultivation of Chlorella vulgaris on effluents obtained after methane	Disposal of methane tank effluent	Developing a method of growing Chlorella vulgaris in effluents after methane	The results of this work will contribute to the spread of biogas technologies	A method of utilization of methane tank effluent using microalgae is	
Object of study by Development a method for utilization of methane tank effluent report					0.1 N NaOH														
Titrimetry																			
Methane tank																			
Analysis of dry content																			

Figure 8: Example of ranking results.

3.4. Application of the audit mechanism in structuring scientific works

Users can also use the specialized audit module described in previous works [15, 16, 17, 29] for all attributes. The graph “Standard” is the ontology itself, containing works that will be supplemented and expanded. This solution will allow users to automatically check whether there is a particular work in the database. Also, this solution will allow checking the hypotheses for compliance with already completed studies. Also, the audit module will allow users to compare an existing METADATA and attributes that are available in ontology at the same time. In particular, these attributes are the materials and methods of the results and the list of sources. Results that do not match the attributes of the “standard” ontology emphasize red. An example

Table 1
Examples of Polyhedron IT platform ranking module

Name of filter (Ontological attributes)	Priority	Main results (list of ontological nodes)
Initial pH (type of data are numbers)	Absolute	Development of a rational way for utilization of meta-tank waste at JSC "Vasylkivska poultry farm", Titrimetry, Methane tank, Development a method for utilization of methane tank effluent Methods for Quantitative Analysis, Materials for researching, Abstract
Methane content, % Vol. (type of data are numbers)	Absolute	Development a method for utilization of methane tank effluent, Development of a rational way for utilization of meta-tank waste at JSC "Vasylkivska poultry farm, Methods for Quantitative Analysis, Materials for researching, Abstract
The ash content, %	Absolute	Development of a rational way for utilization of meta-tank waste at JSC "Vasylkivska poultry farm, Development a method for utilization of methane tank effluent, Methods for Quantitative Analysis, Materials for researching, Equipment, Reagents, Thermophilic, Chicken manure substrate
The dry matter content, %	Absolute	Development a method for utilization of methane tank effluent, Development of a rational way for utilization of meta-tank waste at JSC "Vasylkivska poultry farm Keywords, Methods for Quantitative, Analysis, Materials for researching, Equipment, Thermophilic Chicken manure substrate

of an audit fragment is shown in figure 9.

reports beta v2
(Audit)

#	Indicators	Units	DSTU	Development of a rational way for utilization of meta-tank waste at JSC "Vasylkivska poultry farm"	Development a method for utilization of methane tank effluent
Abstract					
1	Keywords	Keywords	microalgae	Microalgae	Humate
2	Hypothesis	Hypothesis	The effluent obtained after anaerobic digestion can be used as a nutrient medium for microalgae <i>Chlorella Vulgaris</i> .	The effluent obtained after anaerobic digestion can be used as a nutrient medium for microalgae <i>Chlorella Vulgaris</i> .	The solid fraction of methane fermentation of chicken manure can be recycled by the autocatalytic catalysis method.

Figure 9: Example of audit results.

4. Discussion and conclusions

We have proposed to use IMRAD as the main approach to structure the articles in the form of a semantic ontology. As a proof of the concept, we have implemented a universal ontological solution that can provide systematization and structuration of any scientific studies. “Polyhedron” is not a reference manager like “Endnote”, “Mendeley”, and it is also not a scientometric database, but in the nearest perspective, it’s possible to convert our technology into a useful analogue. But, the advantages and potential scenarios for usage of our solution have been demonstrated by the example of biogas studies. The potential of using ranking and auditing tools in the obtained ontological database has been also shown. Numeric and semantic characteristics were separated from the main text and used to process by specialized algorithms of IT Platform Polyhedron. For example, users can find studies where specific method was used by both, using the structure and filtering of studies data. The numeric data of studies are processed by the ranking tool that assigns ranks to nodes depending on the value of these numeric characteristics. The created ontology allows to obtain the structured set of studies, separate their characteristics, provide the possibility to view all of the methods, measured parameters in the view of node and use them to find the studies where they were used. The detailed comparison of our ontological solution with most common analogues is presented on the table 2 below.

Table 2
Comparison of “Polyhedron” system with similar analogues

	Polyhedron*	Mendeley	Endnote	Scopus	Google Scholar
Automatic extraction of the information from any added PDFs	Present	Present	Present	Absent	Absent
Tags, keywords, or search the full text of most PDFs functions.	Present	Present	Present	Present	Present
Ability to cite articles in word/pages	Absent	Present	Present	Absent	Absent
Ability to use numeric data of the articles for ranking	Present	Absent	Absent	Absent	Absent
Accentuation of important semantic characteristics for management of the wide range of articles	Present	Absent	Absent	Absent	Absent
Ability to compare different articles	Present	Absent	Absent	Absent	Absent
Visualization of the information	Present	Absent	Absent	Absent	Absent
Usage of IMRAD approach to sort articles	Present	Absent	Absent	Absent	Absent

* proposed approach using CIT “Polyhedron”

As we can see from the table above, our ontological solution has all of the basic functions of the most common software. Our solution can be used as a bibliographic software and as a scientometric database. In addition, our solution could provide such functions as ranking based on specific attributes, ability to compare different articles, visualization of the information in view of an ontological tree or “ontocubes” and usage of IMRAD approach to sort articles.

References

- [1] U. Noyer, D. Beckmann, F. Köster, Semantic technologies and metadata systematisation for evaluating time series in the context of driving experiments, in: 11th International Protégé Conference, 2009, pp. 1–2. URL: <https://protege.stanford.edu/conference/2009/abstracts/P9-Noyer.pdf>.
- [2] S. Kumar Basak, A Comparison of Researcher’s Reference Management Software: Refworks, Mendeley, and EndNote, *Journal of Economics and Behavioral Studies* 6 (2014) 2220–6140. URL: <https://pdfs.semanticscholar.org/1d41/58017608c841c89794fc9fde70e1c061948e.pdf>.
- [3] V. Kumar, D. Sharma, Cloud Computing as a Catalyst in STEM Education, *International Journal of Information and Communication Technology Education* 13 (2017) 38–51. doi:10.4018/IJICTE.2017040104.
- [4] J. Salem, P. Fehrmann, Bibliographic Management Software: A Focus Group Study of the Preferences and Practices of Undergraduate Students, *Public Services Quarterly* 9 (2013) 110–120. doi:10.1080/15228959.2013.785878.
- [5] S. Ram, K. John Paul Anbu, The use of bibliographic management software by Indian library and information science professionals, *Reference Services Review* 42 (2014) 499–513. doi:10.1108/RSR-08-2013-0041.
- [6] C. Ivey, J. Crum, Choosing the right Management tool, *Journal of the Medical Library Association* 106 (2018) 399–403.
- [7] A. Butros, S. Taylor, Managing information: evaluating and selecting citation management software, a look at EndNote, RefWorks, Mendeley and Zotero, *Proceedings of the 36th IAMSLIC Conference: Mar del Plata, Argentina, 17-21 October, 2010* (2011) 53–66. URL: <http://hdl.handle.net/1912/4595>.
- [8] S. Cuschieri, V. Grech, N. Calleja, WASP (Write a Scientific Paper): The use of bibliographic management software, *Early Human Development* 128 (2019) 118–119. doi:10.1016/j.earlhumdev.2018.09.012.
- [9] D. Parveen, A Graph-based Approach for the Summarization of Scientific Articles, Ph.D. thesis, Ruprecht-Karls-Universität Heidelberg, 2018.
- [10] M. Amami, R. Faiz, F. Stella, G. Pasi, A graph based approach to scientific paper recommendation, in: *Proceedings - 2017 IEEE/WIC/ACM International Conference on Web Intelligence, WI 2017, 2017*, pp. 777–782. doi:10.1145/3106426.3106479.
- [11] D. Boughareb, A. Khobizi, R. Boughareb, N. Farah, H. Seridi, A Graph-Based Tag Recommendation for Just Abstracted Scientific Articles Tagging, *International Journal of Cooperative Information Systems* 29 (2020) 2050004. doi:10.1142/S0218843020500045.
- [12] N. Perraudin, Graph-based structures in data science : fundamental limits and applications to machine learning, Ph.D. thesis, École Polytechnique Fédérale De Lausanne, 2017. URL: <https://infoscience.epfl.ch/record/227982?ln=en>.
- [13] Y. Poulakakis, K. Vassilakis, M. Kalogiannakis, S. Panagiotakis, Ontological modeling of educational resources: a proposed implementation for Greek schools, *Education and Information Technologies* 22 (2017) 1737–1755. doi:10.1007/s10639-016-9511-z.
- [14] Y. B. Shapovalov, V. B. Shapovalov, V. I. Zaselskiy, TODOS as digital science-support environment to provide STEM-education, *CEUR Workshop Proceedings* 2433 (2019) 232–245.

- [15] O. Stryzhak, V. Gorborukov, O. Franchuk, M. Popova, Ontology of the choice problem and its application in the analysis of limnological systems, *Ecological safety and nature management* (2014) 172–183.
- [16] L. Globa, M. Kovalskyi, O. Stryzhak, Increasing web services discovery relevancy in the multi-ontological environment, in: A. Wiliński, I. E. Fray, J. Pejaś (Eds.), *Soft Computing in Computer and Information Science*, Springer International Publishing, Cham, 2015, pp. 335–344. doi:10.1007/978-3-319-15147-2_28.
- [17] L. Globa, S. Sulima, M. Skulysh, S. Dovgyi, O. Stryzhak, Architecture and Operation Algorithms of Mobile Core Network with Virtualization, in: J. H. Ortiz (Ed.), *Mobile Computing*, IntechOpen, 2020, pp. 1–22. doi:10.5772/intechopen.89608.
- [18] V. V. Gorborukov, O. Y. Stryzhak, O. V. Franchuk, V. B. Shapovalov, Ontological representation of the ranking alternatives task, *Mathematical modeling in economics* (2018) 49–69.
- [19] B. Nicolescu (Ed.), *Transdisciplinary: Theory and Practice*, Hampton Press, 2008.
- [20] V. B. Shapovalov, Y. B. Shapovalov, Z. I. Bilyk, A. I. Atamas, R. A. Tarasenko, V. V. Tron, Centralized information web-oriented educational environment of Ukraine, *CEUR Workshop Proceedings 2433* (2019) 246–255.
- [21] D. Martyniuk, M. Falkenthal, N. Karam, A. Paschke, K. Wild, An analysis of ontological entities to represent knowledge on quantum computing algorithms and implementations, *CEUR Workshop Proceedings 2836* (2021) 1–9.
- [22] R. Volckmann, Transdisciplinarity: Basarab Nicolescu Talks with Russ Volckmann, *Integral Review* 4 (2007) 73–90. URL: <https://integral-review.org/transdisciplinarity-basarab-nicolescu-talks-with-russ-volckmann/>.
- [23] Y. B. Shapovalov, V. B. Shapovalov, F. Andruszkiewicz, N. P. Volkova, Analyzing of main trends of STEM education in Ukraine using stemua.science statistics, *CEUR Workshop Proceedings 2643* (2020) 448–461.
- [24] V. B. Shapovalov, Y. B. Shapovalov, Z. I. Bilyk, A. P. Megalinska, I. O. Muzyka, The Google Lens analyzing quality: An analysis of the possibility to use in the educational process, *CEUR Workshop Proceedings 2547* (2020) 117–129.
- [25] Z. I. Bilyk, Y. B. Shapovalov, V. B. Shapovalov, A. P. Megalinska, F. Andruszkiewicz, A. Dolhanczuk-Sródkka, Assessment of mobile phone applications feasibility on plant recognition: comparison with Google Lens AR-app, *CEUR Workshop Proceedings 2731* (2020) 61–78.
- [26] Y. B. Shapovalov, V. B. Shapovalov, R. A. Tarasenko, S. A. Usenko, A. Paschke, A semantic structuring of educational research using ontologies, *CEUR Workshop Proceedings 2879* (2020) 105–123.
- [27] Y. Shapovalov, S. Zhadan, G. Bochmann, A. Salyuk, V. Nykyforov, Dry anaerobic digestion of chicken manure: A review, *Applied Sciences* 10 (2020) 7825.
- [28] V. Ivanov, Y. B. Shapovalov, V. Stabnikov, A. I. Salyuk, O. Stabnikova, M. ul Rajput Haq, Barakatullahb, Z. Ahmed, Iron-containing clay and hematite iron ore in slurry-phase anaerobic digestion of chicken manure, *AIMS Materials Science* 6 (2020) 821–832.
- [29] R. A. Tarasenko, V. B. Shapovalov, S. A. Usenko, Y. B. Shapovalov, I. M. Savchenko, Y. Y. Pashchenko, A. Paschke, Comparison of ontology with non-ontology tools for educational research, *CEUR Workshop Proceedings 2879* (2020) 82–104.

Using a business simulator with elements of machine learning to develop personal finance management skills

Dmytro S. Antoniuk¹, Tetiana A. Vakaliuk^{1,2,3}, Vladyslav V. Didkivskyi¹, Oleksandr Yu. Vizghalov¹, Oksana V. Oliinyk¹ and Valentyn M. Yanchuk¹

¹Zhytomyr Polytechnic State University, 103 Chudnivsyka Str., Zhytomyr, 10005, Ukraine

²Institute for Digitalisation of Education of the National Academy of Educational Sciences of Ukraine, 9 M. Berlynskoho Str., Kyiv, 04060, Ukraine

³Kryvyi Rih State Pedagogical University, 54 Gagarin Ave., Kryvyi Rih, 50086, Ukraine

Abstract

Any person, not even a financier, should be knowledgeable in the field of personal finance management. As a result of the survey, it was concluded that schoolchildren and students should be interested in the study of personal finance, even within other disciplines in the form of separate sections. Successful personal experience and knowledge of the teacher in the field of personal finance is an important component of the effectiveness of the formation of competence of pupils, students, and adults in the field of personal finance. Business simulators come in handy here. That is why the authors developed a business simulator for the development of personal finance management skills, which was developed in the form of a web service. The main features of this simulator, which are presented in different sections of the simulator, are considered. It is shown what skills of personal finance management are developed using this business simulator. Since this simulator was designed to develop personal finance management skills, an attempt was made to apply machine-learning elements to make this business simulator work even better. The proposed simulator can be used in the future to teach the elements of personal finance management to people who are not sufficiently knowledgeable in the field of such finance. Moreover, the web application can be useful even for school-age children, so the simulator can complement the educational process within the economic courses not only in higher education institutions but also in secondary education institutions of Ukraine.

Keywords

business simulator, machine learning, personal finance, personal finance management skills

CoSinE 2021: 9th Illia O. Teplytskyi Workshop on Computer Simulation in Education, co-located with the 17th International Conference on ICT in Education, Research, and Industrial Applications: Integration, Harmonization, and Knowledge Transfer (ICTERI 2021), October 1, 2021, Kherson, Ukraine
✉ dmitry_antonyuk@yahoo.com (D. S. Antoniuk); tetianavakaliuk@gmail.com (T. A. Vakaliuk); v.didkivskyi@sana-commerce.com (V. V. Didkivskyi); aleksandrviszur@gmail.com (O. Yu. Vizghalov); oov76@ukr.net (O. V. Oliinyk); v.yanchuk@gmail.com (V. M. Yanchuk)
🌐 <https://sites.google.com/view/neota> (T. A. Vakaliuk)
🆔 0000-0001-7496-3553 (D. S. Antoniuk); 0000-0001-6825-4697 (T. A. Vakaliuk); 0000-0002-4615-7578 (V. V. Didkivskyi); 0000-0003-0985-4929 (O. Yu. Vizghalov); 0000-0003-2188-9219 (O. V. Oliinyk); 0000-0002-6715-4667 (V. M. Yanchuk)

© 2022 Copyright for this paper by its authors.
Use permitted under Creative Commons License Attribution 4.0 International (CC BY 4.0).
 CEUR Workshop Proceedings (CEUR-WS.org)

1. Introduction

Almost every day, each person spends money on housekeeping, utility bills, payment for services and purchases. It also includes debts on loans, or just borrowed money from friends. Personal finance includes all the funds available to us and the ability to manage them, so the topic of personal finance is relevant and worthy of attention for everyone who cares about their financial well-being. That is why any person, not even a financier, should be knowledgeable in the field of personal finance management. As a result, a survey was conducted to find out certain aspects of the financial literacy of first-year students as individuals who have their financial resources. In 2019, 167 respondents took part in the survey, in 2020 – 214 respondents (first-year students of the Faculty of Information and Computer Technologies of the Zhytomyr Polytechnic State University).

As a result, it was found that in 2019, 70.7% of respondents consider themselves financially literate, ready to consciously and effectively manage their own and family financial resources; in 2020 – 74.3%. At the same time, 29.3% of respondents in 2019 do not consider themselves sufficiently aware in this regard; in 2020 – 25.7% (see figure 1, a).

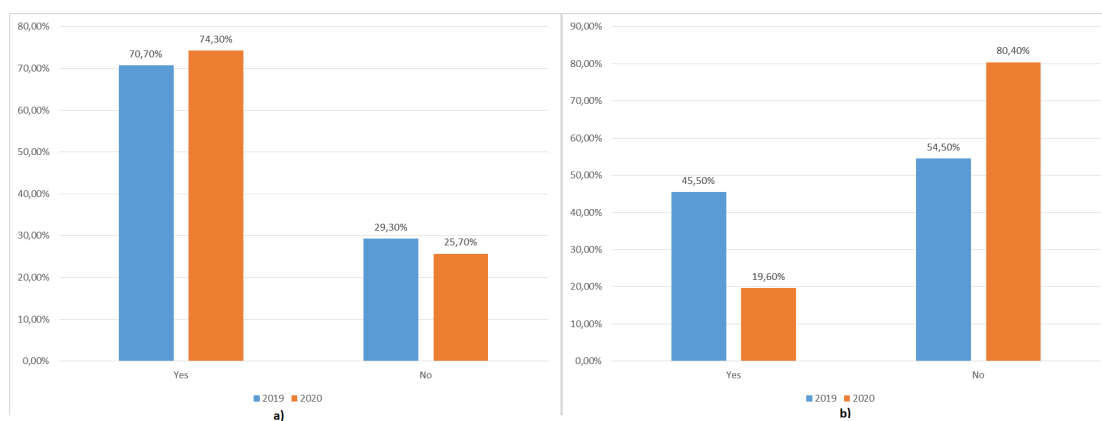

Figure 1: Financial literacy education results.

It was also found that in 2019 45.5% of respondents studied the basics of financial literacy in at least one form, in 2020 – this figure dropped to 19.6%, in 2019 54.5% – did not study in any form, in 2020 – this figure is 80.4% (see figure 1, b).

In addition, by the results of the survey, it was found that in 2019 14.4% of respondents at the highest level assess their level of readiness for conscious and effective management of own and family financial resources, in 2020 – 10.7%, 38.3% of respondents in 2019 – indicated the level of readiness “good” and “satisfactory”, while in 2020 46.7% indicated the level of readiness “good”, 35% - “satisfactory”. All others either rated the level at the lowest level or an unsatisfactory level.

As a result of the survey, it was concluded that schoolchildren and students should be interested in the study of personal finance, even within other disciplines in the form of separate sections. Successful personal experience and knowledge of the teacher in the field of personal finance is an important component of the effectiveness of the formation of competence of pupils,

students, and adults in the field of personal finance. Business simulators come in handy here.

1.1. Theoretical background

The need for personal finance competency development was analyzed in the research internationally. The challenge is relevant for both developed and developing countries. Influence of the financial literacy on the well-being of people worldwide and the need to recognize it as the fundamental right and universal need was discussed by Lusardi [1]. Another research by Lusardi et al. [2] shows that in the USA 30–40% of retirement wealth inequality is associated with the level of financial literacy alone. As for the initial personal finance management, knowledge, and skills formation, the study concludes significant influence of the high school financial literacy courses on the lower default rates and better credit scores [3].

Using business simulations in education is a shared practice now. Simulations are being used in practical training, such as flight or combat simulations as well as in economic, managerial, and financial areas. Researchers study the pedagogical significance of this type of technology-enhanced educational method. The group of researchers from the consortium of Spanish universities concluded the positive impact of business simulations on the generic competencies [4]. Farashahi and Tajeddin [5] conclude the effectiveness of business simulations in their comparative study. The study of business simulations in economic or finance evolves with the evolution of technologies available to develop immersive, attractive, and highly functional experiences. The range of use-cases differs from elementary schools to life-long learning establishments. Korgin [6] provides evidence of the effectiveness of the simulation games for kids with basic arithmetical operations literacy. Palan [7] studied the criterion and approaches to select business simulation software for asset market experiments to use in the higher education establishments.

The analysis provides evidence of the effectiveness of business simulation usage in education in general and the need to further development of business simulation for the economy and finance literacy development, assessment, and study of its behavioral aspects.

2. Results

The analysis of the analogues revealed that most part of the simulation software is appropriate for a specific area of the finance in the countries with developed financial markets. Based on the conclusions above this work represents the experiment in developing more generalized simulator for the countries with less developed market of financial instruments [8].

That is why the authors developed a business simulator for the development of personal finance management skills, which was developed in the form of a web service [9]. Consider the main features of this simulator, which are presented in different sections of the simulator (see figure 2):

1. Current account management options.
2. Savings management options.
3. Deposit management options.
4. Credit management options.

5. Non-financial investment management options.
6. Information on changes in current accounts that have occurred in the last week.
7. Analytical information on the dynamics of changes in current account funds, savings, and investments.
8. Information on current exchange rates.
9. List of recent transactions that have been made on current accounts.

Consider in more detail the section with current account management options (see figure 2, A). The “Current account” section contains a list of current accounts in the form: code and available amount.

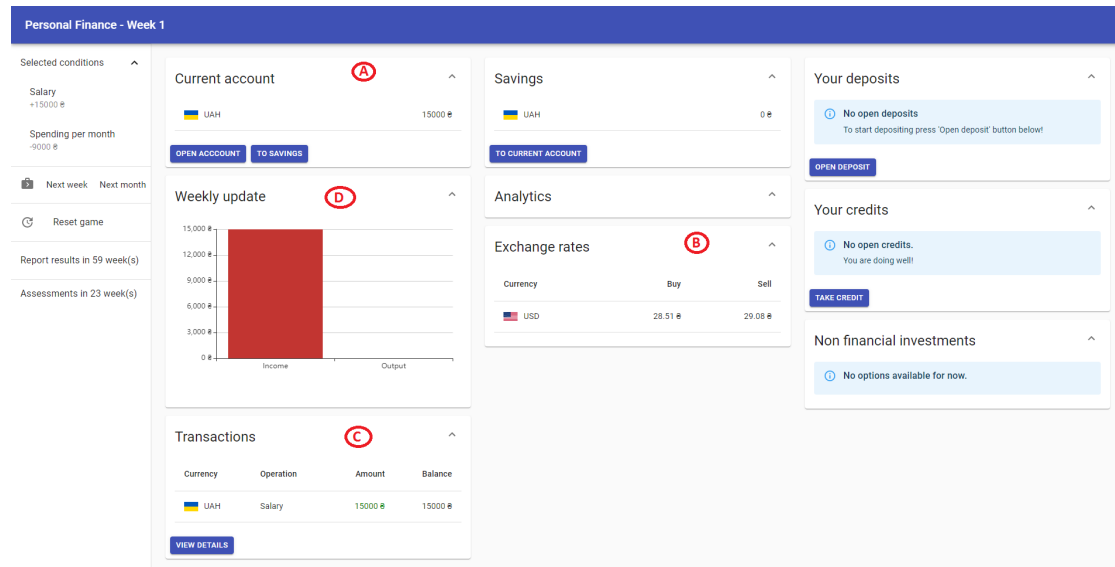

Figure 2: Business simulator.

The user has the opportunity to open a new account. To do this, click on the “Open account” button, then a window will appear where you need to select the currency in which you want to open a new account (see figure 3). Each user action in the simulator (for example, opening a new account) is accompanied by a message that appears in the lower right corner of the page (see figure 4).

After opening a new account, the “Exchange” option will be available in the “Current account” section, which allows you to exchange currencies at the rate that can be viewed in another section “Exchange rates” (see figure 2, B).

To exchange currencies, the user can enter the amount he wants to sell and the amount in the currency to be purchased will be filled in automatically. The user can also enter the amount to purchase and the amount required for the purchase will be filled in automatically. The user can also change currencies and the amounts will be automatically transferred.

In the process of performing all actions by the user, a real-time section is available with information about changes in current accounts that have occurred in the last week (see figure 2, D).

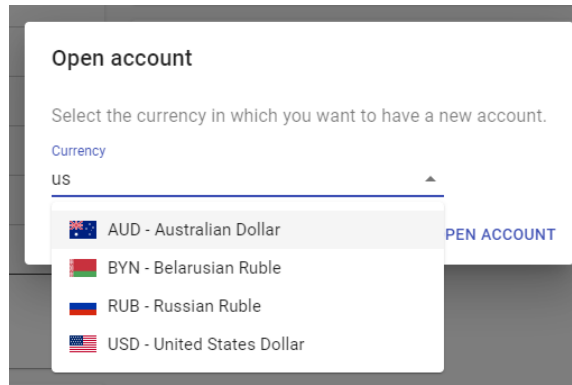

Figure 3: Example of opening a new account.

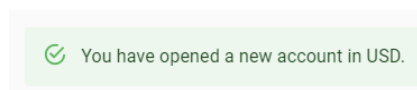

Figure 4: Example of message.

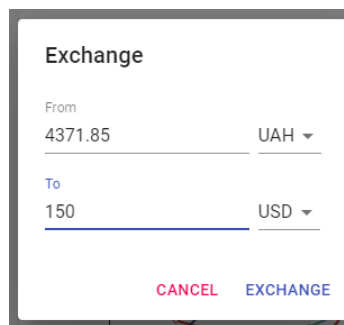

Figure 5: Example of currency exchange.

The user can choose the currency of the account for which he wants to see the relevant data (see figure 5).

In addition, in the simulator, there is a section with analytical data on the dynamics of changes in current account funds, savings, and investments since the beginning of the simulation (see figure 6). The user can select the currency of the account for which he wants to see the information. By default, to visualize the dynamics of funds in all accounts, the option “Accounts total amount in USD” is selected, which displays the total amount of funds in all accounts converted into USD.

The user also can view transaction information on all current accounts (see figure 2, C). The corresponding section contains a list of the last 5 transactions. In this case, the user can view all transactions or filter them by specific weeks in the details window (see figure 7).

At the beginning of the 4th week of the simulation, a window with a test question appears, in which the participant is asked what the amount is enough to save for savings from a monthly

Analytics

Accounts total amount in USD ▾



Figure 6: Analytical information on the dynamics of changes in current account funds, savings, and investments.

Transactions

Start week

21

End week

24

Currency	Operation	Amount	Balance
UAH	Transfer from savings	2000 ₪	2314.24 ₪
USD	Completed deposit 'Standard (3 months)'	400 \$	400.84 \$
USD	Deposit 'Standard (3 months)'	0.42 \$	0.84 \$
UAH	Regular spending	-1250 ₪	314.24 ₪
UAH	Regular spending	-1250 ₪	1564.24 ₪

CLOSE

Figure 7: List of transactions with the filter by weeks.

salary per month. This question is part of the assessment, and the user is obliged to answer it.

To sometimes distract the user from financial instruments and bring more of the reality into the simulation process, random events were added to the system, including various diseases, repairs, the birth of a child, and so on. Most random events last for some time and additional costs for the entire period of validity.

Some events are constant, so costs are made every week, such as the birth of a child. You can't cancel any random event, you can just accept it and close the window.

Upon reaching the 60th week of the simulation, the user will be shown a page where the participant can view analytical data on the dynamics of changes in funds on all current accounts, savings, and investments since the beginning of the simulation (see figure 8). Funds on all accounts, savings, and investments are converted into USD and shown in one chart. On this page, the user can compare their results with the results of other participants in their country, as well as from other countries, in addition, they can share their thoughts or ideas about the simulator by filling in the field at the bottom of the page.

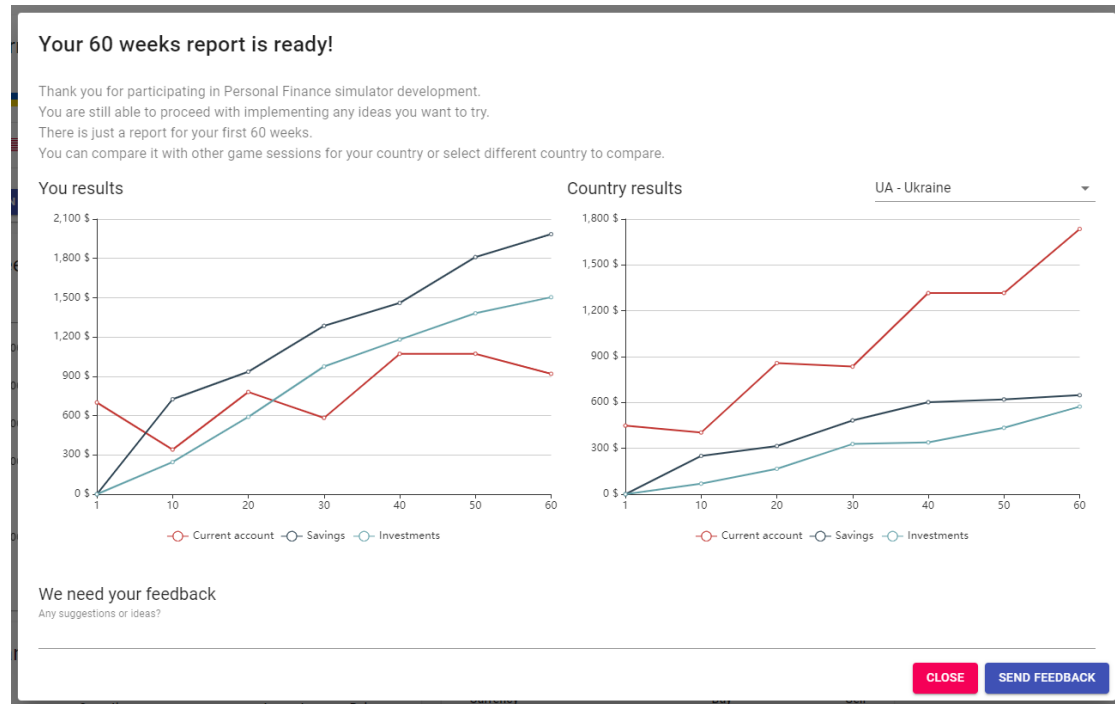

Figure 8: Example of simulation results.

The use of the Simulator facilitates forming of the following knowledge, skills, and competencies as well as the personal attitude towards:

- Using the diversified list of currencies.
- Forming widely-acknowledged standard of emergency savings and assessing readiness for longer-term investment.
- Using basic saving and investment instruments available in a wide range of countries such as deposits (deposit certificates), real estate, and business investments. Experiencing different types of instruments and understanding their specific.
- Debt-management and forming personal behavioral attitude to using debt as constructive investment leverage.

Since this simulator was designed to develop personal finance management skills, an attempt was made to apply machine-learning elements to make this business simulator work even better. This requires the creation of a system that could determine for the user an effective strategy of action in the simulator because the amount of real data of simulation participants is extremely small for analysis and identification of hidden dependencies using cluster analysis. This task is suitable for those that are solved by the latest approach in machine learning, namely reinforcement training.

Reinforcement learning (RL) is a type of machine learning in which the agent directly examines environmental data, receives rewards, and sets policies for optimal action. The goal of RL is to find the optimal policy that maximizes the expected amount of future rewards [10].

Reinforcement learning focuses primarily on how to obtain the optimal strategy [10]. Ideally, the system should determine what will be financially optimal, as well as understand what is inherent in man, given its characteristics. For example, if a person has never used investment instruments, it is not worth building a strategy for him with too aggressive investment behavior, because it is unlikely that a person will follow it.

Reinforcement learning includes an agent, a set of states S , and a set of actions by states A . By acting $a \in A$, the agent moves from state to state. Acting in a certain state provides the agent with a reward. The agent's goal is to maximize his overall (future) reward. He does this by adding the maximum reward that can be achieved from future states to the reward for reaching his current state, thus influencing the current action with a potential future reward. This potential reward is the sum of the rewards of all subsequent steps, starting from the current state.

Formally, reinforcement learning is modeled as a Markov decision-making process (MDP). MDP provides a mathematical basis for modeling decision-making in situations where the results are partly random and partly controlled by the decision-maker [11].

One of the algorithms of reinforcement training is Q-training. The purpose of Q-learning is to learn a strategy that gives the agent information about which step is best to perform in a particular state S .

The algorithm contains the following elements:

- r_t the reward received in the transition from state s_t to state s_{t+1} ;
- α – the pace of learning, which determines the extent to which new information will override old information;
- γ – depreciation ratio, which gives the effect of valuing rewards received earlier, higher than those received later.

Before training, Q is initialized with an arbitrary fixed value (selected by the programmer), for example, 0. Then, at each point in time t , the agent selects an action a_t , receives a reward r_t , moves to a new state s_{t+1} (which may depend on both the previous state s_t and the selected action), and table Q is specified. The core of the algorithm is the Bellman equation as a simple update of values by iteration, using the weighted average old value and new information [12].

As a result, the open-source library “SharpRL” was chosen [13]. This library provides basic functionality for developing a learning environment with reinforcement based on the Q-learning algorithm. The program for defining personal financial strategies is a console application. Running this program involves setting certain parameters, including:

$$Q^{new}(s_t, a_t) \leftarrow \underbrace{Q(s_t, a_t)}_{\text{old value}} + \underbrace{\alpha}_{\text{learning rate}} \cdot \underbrace{\left(\underbrace{r_t}_{\text{reward}} + \underbrace{\gamma}_{\text{discount factor}} \cdot \underbrace{\max_a Q(s_{t+1}, a)}_{\text{estimate of optimal future value}} - \underbrace{Q(s_t, a_t)}_{\text{old value}} \right)}_{\text{new value (temporal difference target)}}$$

Figure 9: Q-learning algorithm.

- number of simulation passes in training mode;
- the number of simulations in the mode of compliance with the model policy after training;
- duration of the simulation in weeks;
- monthly income and expenses of the user in a certain currency, which will be determined as the main currency of this user.

At the end of the training process, the screen will display the maximum reward that was achieved during the program; data on the user in the last week, which include: funds in current accounts, amounts invested in deposits and savings of the user; the best way that was found during the operation of the system. Each step of the path is an action that is recommended for the user to perform in a particular week. For more information, user data is displayed next to each step after performing the specified operation.

To have more opportunities to analyze the results, the program saves them in a CSV file, which can be used to compare the data with data from other launches of the program.

The generated file has only two columns: the first – indicates the week of the simulation, the second – the reward received by the user this week.

As a result, the operation of the system with different initial parameters was analyzed and it was found that a small number of iterations is the cause of an untrained model, which results in unstable results. Experiments were conducted and it was hypothesized that the optimal ratio of initial parameters, namely: the number of simulation passes in the training mode and the number of simulation passes in the mode of adherence to the model policy after training, is close to 1000. It was found that best results. After attempts to increase these figures, the results remained within the statistical error. For example, figure 10 shows the result of increasing the number of training epochs to 2000, which, compared to the results of 1000 epochs, remained almost unchanged. As a result of the study, it was concluded that with the current set of possible actions in the system (for example, to open a deposit of 10% of profits, etc.), increasing the number of training epochs does not improve the result.

To test the trained model, a method of comparing the results of the system with the average values of the results of the passage of real users in the developed simulator was chosen. Thus, it was decided to take a certain period, for example, 54 weeks, and collect user data using the available functionality of the simulator. Based on the collected user data and the results of the trained model, several comparative graphs with different indicators of income and expenses were constructed.

It was found that for 54 weeks, the system shows consistently better results than the average results of users who underwent the simulation. From the graph, you can see that the performance

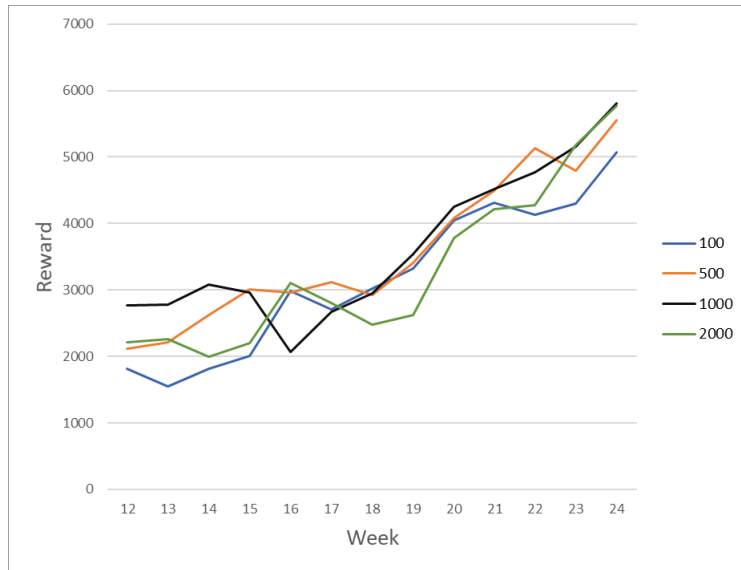

Figure 10: Results with different number of epochs of training in the mode of adherence to the trained model.

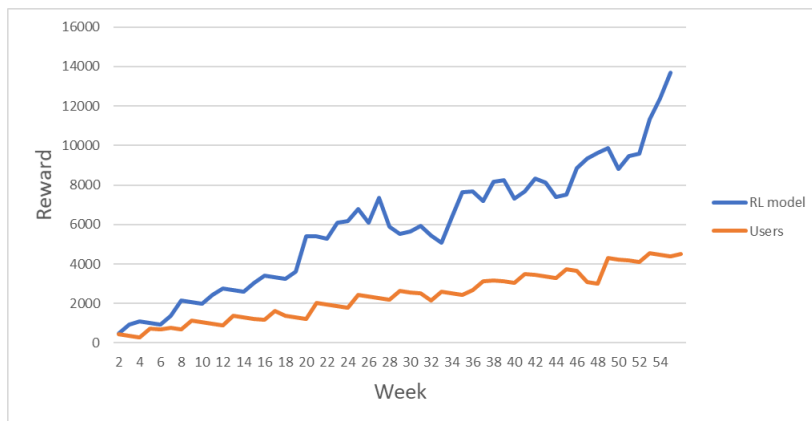

Figure 11: Comparison of model and user results with parameters of UAH 15,000 income and UAH 9,000 costs.

of the model is growing from week to week, which means that the system adapts to the environment.

After increasing the parameters of profit and expenses, the difference in the graphs becomes more significant in favor of the trained model. This is shown in figure 11, 12, 13.

Jumps can be seen in the graph showing the results of the reinforcement learning model. They can be seen more often on charts where higher incomes and a large difference between income and expenses. This is the effect of specific rules that are described to train the model so that the virtual agent system follows the best path. For example, if an agent has opened a deposit for 3 months, after this period the deposit will be closed automatically and this closing

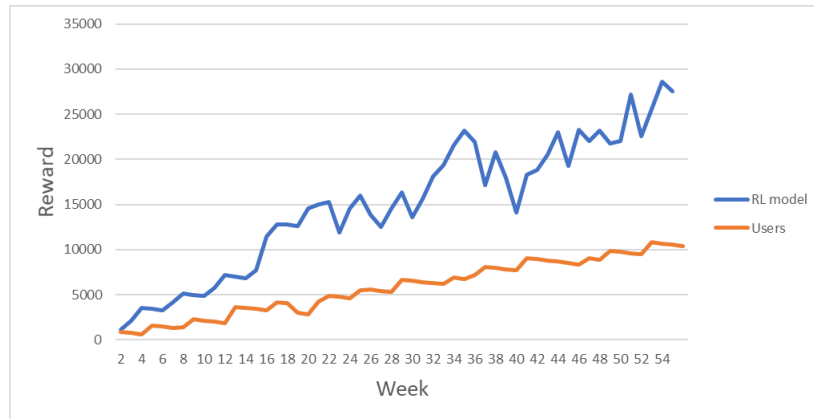

Figure 12: Comparison of the results of the model and users with the parameters of UAH 30,000 income and UAH 15,000 costs.

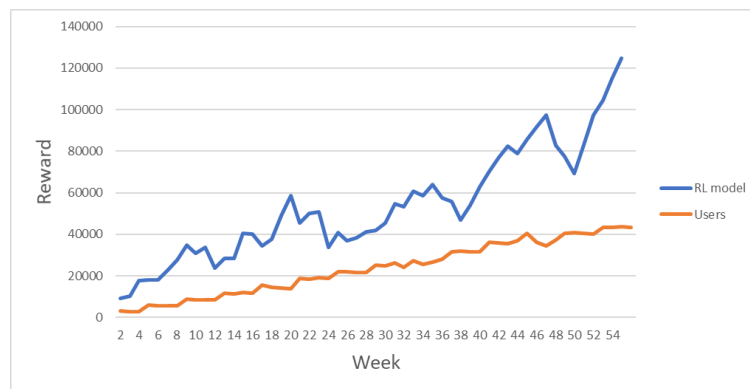

Figure 13: Comparison of the results of the model and users with the parameters of UAH 100,000 income and 30,000 UAH costs.

of the deposit will significantly affect the user’s reward for this week. However, the system learns and “understands” where to invest or save. As a result, this leads to sharp increases in performance, as seen in the graphs. In the graphs responsible for the results of real users, such behavior is not observed, which indicates the ignorance of users with effective ways to manage personal finances within the developed simulator.

3. Conclusions

Currently, economic processes are a new topic for research into the possibilities of applying the full potential of machine learning. Scientists from around the world are just making the first attempts to reproduce such processes programmatically to use artificial intelligence to find solutions and answer various economic questions of humanity.

The proposed developed software package consists of two parts: a personal finance management simulator and a system for determining effective financial strategies, which uses

reinforcement learning opportunities.

The proposed simulator can be used in the future to teach the elements of personal finance management to people who are not sufficiently knowledgeable in the field of such finance. Moreover, the web application can be useful even for school-age children, so the simulator can complement the educational process within the economic courses not only in higher education institutions but also in secondary education institutions of Ukraine.

The prospects for further research include testing the effectiveness of the proposed simulator of personal finance as a learning tool.

References

- [1] A. Lusardi, Financial literacy and the need for financial education: evidence and implications, *Swiss Journal of Economics and Statistics* 155 (2019) 1. doi:10.1186/s41937-019-0027-5.
- [2] A. Lusardi, P.-C. Michaud, O. S. Mitchell, Optimal financial knowledge and wealth inequality, *Journal of Political Economy* 125 (2017) 431–477. doi:10.1086/690950.
- [3] C. Urban, M. Schmeiser, J. M. Collins, A. Brown, The effects of high school personal financial education policies on financial behavior, *Economics of Education Review* 78 (2020) 101786. doi:j.econedurev.2018.03.006.
- [4] A. B. Hernández-Lara, E. Serradell-López, À. Fitó-Bertran, Students' perception of the impact of competences on learning: An analysis with business simulations, *Computers in Human Behavior* 101 (2019) 311–319. doi:10.1016/j.chb.2019.07.023.
- [5] M. Farashahi, M. Tajeddin, Effectiveness of teaching methods in business education: A comparison study on the learning outcomes of lectures, case studies and simulations, *The International Journal of Management Education* 16 (2018) 131–142. doi:10.1016/j.ijme.2018.01.003.
- [6] N. Korgin, Introduction to theory of control in organizations for kids via interactive games, *IFAC-PapersOnLine* 48 (2015) 289–294. doi:10.1016/j.ifacol.2015.11.250.
- [7] S. Palan, GIMS—Software for asset market experiments, *Journal of Behavioral and Experimental Finance* 5 (2015) 1–14. doi:10.1016/j.jbef.2015.02.001.
- [8] D. S. Antoniuk, T. A. Vakaliuk, V. V. Didkivskyi, O. Y. Vizghalov, Development of a simulator to determine personal financial strategies using machine learning, *CEUR Workshop Proceedings* 3077 (2022) 12–26. URL: <http://ceur-ws.org/Vol-3077/paper02.pdf>.
- [9] Personal finance, 2020. URL: <https://financesimulator.azurewebsites.net/>.
- [10] R. S. Sutton, A. G. Barto, Reinforcement learning: an introduction, 2nd ed., The MIT Press, Cambridge, 2015. URL: <https://web.stanford.edu/class/psych209/Readings/SuttonBartoIPRLBook2ndEd.pdf>.
- [11] M. L. Puterman, Markov decision processes: Discrete stochastic dynamic programming, John Wiley & Sons, Inc., 2008. doi:10.1002/9780470316887.
- [12] C. J. C. H. Watkins, P. Dayan, Technical Note: Q-Learning, *Machine Learning* 8 (1992) 279–292. doi:10.1023/A:1022676722315.
- [13] SharpRL, 2019. URL: <https://github.com/svenslaggare/SharpRL>.

Modeling of the internal certification system of educational resources

Oksana P. Buinytska, Svitlana V. Vasylenko

Borys Grinchenko Kyiv University, 18/2 Bulvarno-Kudriavska Str, Kyiv, 04053, Ukraine

Abstract

The article analyzes the research, which was carried out for several years to model the system of internal certification of educational resources for blended and e-learning in Higher education. The authors describe the prerequisites for the internal certification system modeling and the features of recent changes in the process of internal certification of educational resources, approved by the university regulations, which is related to the requirements of the situation with COVID-19. The article describes the current model of the system of internal certification of educational resources, which is based on the approbation of the pilot model of e-learning courses (hereinafter – ELC) certification. The key components of the internal certification system are three mandatory expertise (professional, resource and technical). Based on the results of which, the methodological commission decides on the quality of educational resources of the ENC and its certification. Expectations from the current system of internal certification of ELC implementation were justified to a high degree, in particular, we have the following advantages of their use: the creation of quality educational resources, expanding access to various categories of participants in the educational process to educational content; ensuring the individualization of the educational process under the needs, characteristics and capabilities of learners; improving the quality and efficiency of the educational process through the use of digital and innovative educational technologies; ensuring systematic monitoring of the quality of education, implementation of blended and e-learning in higher education.

Keywords

internal certification system, e-learning courses, ELC, educational resources

1. Introduction

The situation with COVID-19, such as social distance, limited access to classrooms, the transition to blended and e-learning, today requires a change in many dimensions in higher education. Not only approaches to the educational process need to be transformed, but also the consciousness of teachers, their psychological attitude and motivation to actively use e-resources in the process of implementing blended and e-learning [1, 2].

The implementation of blended and e-learning in the educational process has prompted the administration to take decisive action to involve teachers in creating teaching materials in

CoSinE 2021: 9th Illia O. Teplytskyi Workshop on Computer Simulation in Education, co-located with the 17th International Conference on ICT in Education, Research, and Industrial Applications: Integration, Harmonization, and Knowledge Transfer (ICTERI 2021), October 1, 2021, Kherson, Ukraine

✉ o.buinytska@kubg.edu.ua (O. P. Buinytska); s.vasylenko@kubg.edu.ua (S. V. Vasylenko)

🌐 <http://eportfolio.kubg.edu.ua/teacher/21> (O. P. Buinytska); <http://eportfolio.kubg.edu.ua/teacher/59>

(S. V. Vasylenko)

🆔 0000-0002-3611-2114 (O. P. Buinytska); 0000-0002-5790-572X (S. V. Vasylenko)

© 2022 Copyright for this paper by its authors.
Use permitted under Creative Commons License Attribution 4.0 International (CC BY 4.0).



CEUR Workshop Proceedings (CEUR-WS.org)

various electronic formats, and subsequently to introduce a more rigorous system for assessing the quality of teaching materials used by students. General global trends in education require a transformation, because on the one hand the generation of students who need modern resources, on the other hand, the challenges of the pandemic do not leave alternatives in choosing the form of education [3, 4].

Higher education institutions try in different ways to solve the issue of ensuring the quality of e-learning, including e-courses and e-content through the development of standards and the creation of e-learning systems [5], implementing many-sided evaluation of e-learning and digital competences of teachers [6]. An important factor influencing the quality of educational e-resources is determined by their students' assessment both in the process of use and upon completion of work in e-courses through various surveys [7, 8].

To ensure the quality of educational resources, it is necessary to implement their comprehensive evaluation, which includes students' assessment of e-course, expertise of the e-resources and determination of technological feasibility of e-course components.

From this point of view, the preparation of quality educational resources for higher education can be provided by the university system of internal certification.

The research aimed at modeling the system of educational resources internal certification for blended and e-learning in University took place in several stages:

1. Creation the pilot model of the e-learning courses (hereinafter – ELC) certification.
2. Approbation of the pilot model of e-learning courses certification.
3. Development of internal certification system of educational resources for blended and e-learning in higher education.

The approbation pilot model for e-course certification, those ELC which teachers created as an additional resource to support academic disciplines, was tested by collectively discussing the results of the implementation. At the same time, trainings were held for teachers who wanted to be at the forefront of promoting blended and e-learning at the University.

The research was managed by IT in Education Laboratory together with institutes and faculties of Borys Grinchenko Kyiv University. The development of the system of internal certification of educational resources for blended and e-learning took place at the University level and resulted in the approval of the Regulations on the creation and certification of e-learning courses, which is the main tool for the internal certification of educational resources offer for University [9].

It should be noted that until the approval of the internal certification system to ensure education at the University, only 9% of certified ELC were used for bachelor's degree, and 18% for master's degree [10].

The current model of the internal certification system of educational resources, which is described later in the article, is based on the analysis of the results of testing the pilot model of ELC certification, the description of which is presented in the manual [11].

2. ELC design in the e-Learning system

The university e-learning system is a special educational portal built on the Moodle platform, which allows you to create learning material that is stored as a structured ELC and through

which is implemented as blended and e-learning [12]. The e-learning system is designed to provide the educational process at the university.

For effective work of teachers and students in the e-learning system were created personal digital cabinets of users (students, teachers, administrators), which provide quick access to useful digital resources: class schedule, means of communication and cooperation with colleagues and students, libraries (scientific materials, access to scientometric databases, etc.), electronic portfolio systems, search for scientific publications and checking student work for plagiarism, questionnaires for students to assess ELC, catalog of courses of choice for university students and other useful links [13, 14].

In the personal cabinet, teachers have the opportunity to use filters to show the ELCs they are currently working with, view their own workload, work with the automated module “Individual teacher plan” and so on.

ELC are formed automatically in accordance with the curricula of higher education students in the academic/educational professional program of the university. The ELC is developed by authors, which can be a teacher or a team of teachers, who are appointed by the decision of the department of the university from among the academic staff/professors/lecturers/employees of the university. In the future, teachers are enrolled in the ELC and their role is defined: author, author-teacher, teacher with appropriate levels of access.

The developed ELC is the property and intellectual property of the University and must have a unified structure and meet the following characteristics:

- structured teaching and methodical materials;
- logical configuration of the discipline studies;
- a clear schedule for students to complete the curriculum;
- the system of interactive interaction of participants of educational process among themselves, means of resources of ELC and technologies of distance learning, during all time of studying of discipline is adjusted;
- high-quality training materials that allow the form of competencies declared in the working program of the academic discipline;
- system of control and evaluation of all types of educational activities of students.

Electronic resources included in the ELC have two types according to the level of student activity. Resources are designed to provide students with the content of educational material, such as structured electronic lecture notes, multimedia lecture presentations, audio and video materials (podcasts, videocasts, webcasts, etc.). And methodical recommendations, resources that ensure the development of the studied material, the formation of skills, acquisition of general and special (professional) competencies, self-assessment and evaluation of educational achievements of applicants, for example: tasks, testing, questionnaires, forums, etc. including the use of digital technologies. The digital learning technologies encourage the development of cognitive, creative, communicative and collaborative skills [15, 16] using ELCs, which are developed for each discipline of the curriculum.

3. ELC structure

The structure of the ELC needs obligatory components of the ELC, approved by the Regulations on the procedure for creating e-learning courses, their certification and use in the e-learning system of Borys Grinchenko Kyiv University [9]:

1. The section with the description of ELC with the indication of the the Academic/Education Professional Program (name, educational level), contains the reference to the actual working program of educational discipline in the Institutional repository; general information about the discipline (resources: working program; evaluation criteria; printed and Internet sources; glossary; announcements; information about the author);
2. Teaching and methodical materials from each content module:
 - theoretical material (structured electronic learning materials, manual in the form of resources Lecture or Book, multimedia presentations of lectures, audio, video, animation learning resources, a list of printed and Internet sources);
 - practical/seminars/laboratory works (content, methodical instructions on their performance, list of tasks, form of presentation of results of performance, terms of performance, evaluation criteria);
 - tasks for individual work of applicants (content, guidelines for their implementation, list of tasks, form of submission of results, deadlines, evaluation criteria);
 - module control (control questions, tasks, form of work submission, deadlines, evaluation criteria);
3. Materials for the final control in the form of an examination (description of the procedure, examination program or references, indicative list of questions, evaluation criteria); in the resource Exam give a brief description indicating the procedure for the exam and evaluation criteria.
4. Additional materials.

Special conditions: if the course is practical, it is advisable to present theoretical information in at least one general resource Lecture or Book; for courses where listening, speaking, etc is obligatory, the form of submission of the completed work in the form of audio or video file, communication/interview in voice or video chat is allowed.

4. The ELC internal certification system

4.1. Model of the ELC internal certification system

The process of testing the pilot model lead to its significant modeling and design of a qualitatively new integrated system of internal certification of educational resources for blended and e-learning (figure 1).

The ELC internal certification system is regulated by the approved Regulations and, accordingly, is carried out monthly following the decisions of the Academic Councils of the institutes and faculties of the university.

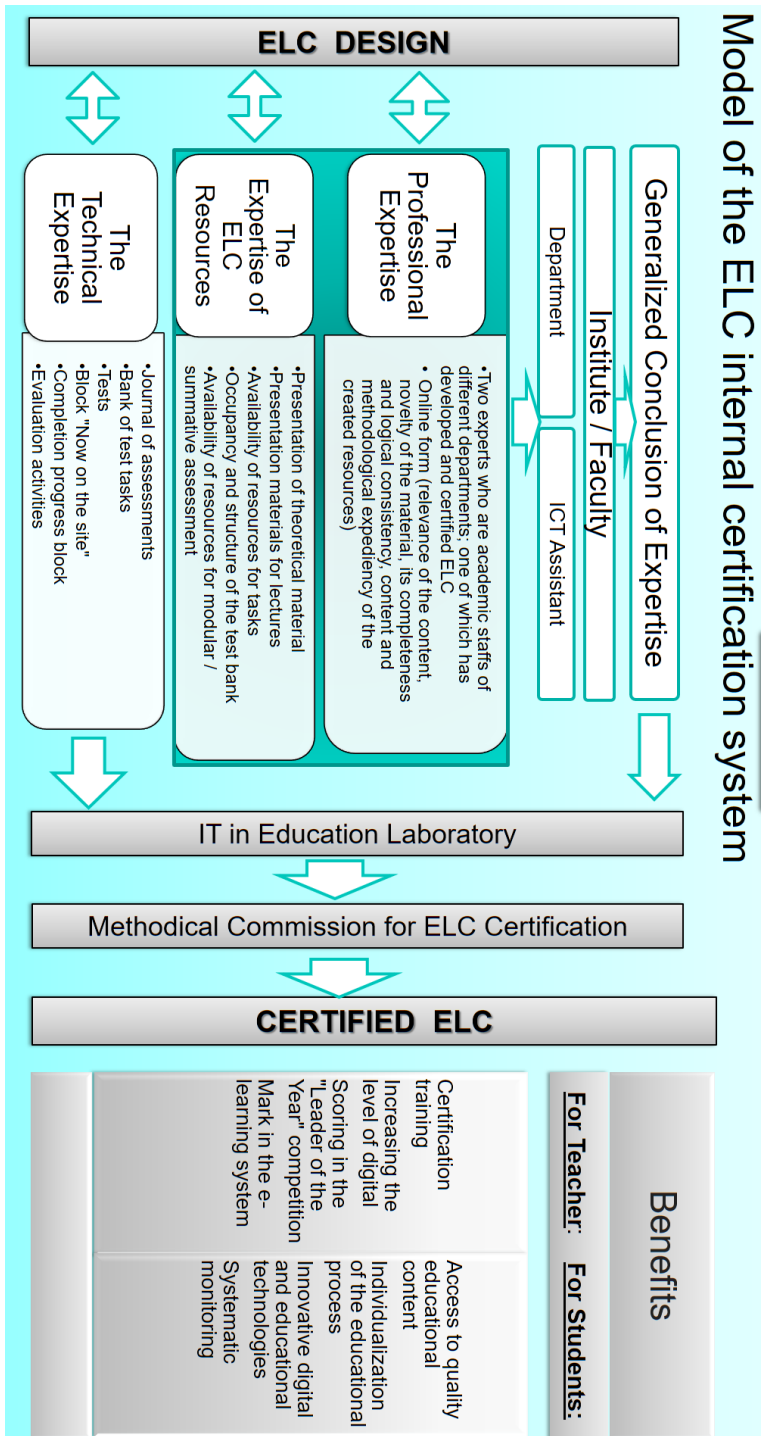

Figure 1: Model of the ELC internal certification system

The main processes of the certification system presented in the model are: ELC design; organization and conduct of expertise; analysis of expertise results and certification decision-making.

During the professional expertise the scientific level of the course materials is determined, the correspondence of all created resources to the working programs, goals and objectives of the discipline. The relevance of the content, novelty of the submitted material, its completeness and logical consistency, content and methodological expediency of the created resources, methodological aspects of the course organization, pedagogical and psychological bases of organization of students' and pedagogical staffs' educational activity, their interaction, organization of control system are analyzed.

The procedure for managing a professional expertise includes the following steps:

- 1) appointment of experts by the director dean of the structural unit;
- 2) online expertise by appointed experts with conclusion;
- 3) discussion of the results of the expertise at the meeting of the department.

The expertise of ELC resources is carried out by the ICT Assistant Director/Dean and involves the analysis of the availability of obligatory ELC components and the determination of the level of compliance of each component with the requirements specified in the regulation. The passing score for the expertise of ELC resources for further submission for technical examination is 70 (out of 130 possible).

The professional expertise and expertise of resources takes place in the first two weeks of the current month, after which the ICT assistant can acquaint the author/authors with the conclusions of the expertise.

The generalized conclusion of the ELC examination is signed by the director/dean and submitted by the ICT assistant to IT in Education Laboratory.

The technical expertise of the ELC is carried out by the IT in Education Laboratory at the request of structural units with obligatory monitoring in an online document, which is set up open access for viewing to all participants in the educational process. Technical expertise provides an analysis of the implementation of system-wide requirements: the correct operation of the Journal of Assessments; optimal filling of the test bank; correct test setup; availability and settings of blocks "Now on the site", "Progress of completion"; setting deadlines for tasks.

4.2. Key-steps of the ELC internal certification

The ELC certification decision is made by the methodical commission for ELC certification, the composition of which is approved by the order, is adopted collectively based on the generalized conclusion of the head of structural division based on conclusions of expertise.

Authors should initiate ELC certification and take the following steps:

1. Send a request to the ICT Assistant to lead an expertise of resources and request the appointment of the director/dean of the structural unit of experts (at least 2 people who are employees of different departments; one of which has developed and certified ELC. Specialists from other structural unit of the University and/or educational and scientific institutions may be also involved.

2. Enroll experts in the ELC and invite them by letter with a link to the ELC and password access.
3. Monitor and respond on time to the results of the expertise submitted by experts through the online form “Professional expertise”. (Viewing the results of professional expertise is open and available on a corporate account).

The results of each stage of certification are reflected in a free-to-view document, which allows authors to make adjustments to the submitted ELC in accordance with the submitted recommendations.

5. The impact of certification on the quality of learning resources for blended and e-Learning

In a pandemic, the university’s educational process was organized using e-learning, to ensure which the university’s e-learning system was used quite actively in combination with online communication and collaboration tools [11].

The number of activities by both teachers and students of higher education has increased many times, which confirms a significant increase in the use of ELC. The number of actions of students in 2020 exceeded 9 million and, compared to 2019, increased more than 3 times, teachers – exceeded 2,5 million, an increase of 4 times, due to the processing of educational material, performance and loading of tasks applicants, checking the downloaded tasks, as well as filling the ELC with educational content and keeping a journal of assessment by teachers.

Ensuring the quality of educational resources with which students work has become an important task for the University teachers.

The number of ELCs created in 2020 has almost doubled compared to 2019, which made it possible to provide ELCs to almost 90% of disciplines, of which 60% of ELC are fully developed and fully used in the study of disciplines, others are gradually filled with educational content and used for keeping a log of assessments.

Analysis of ELC that are actively used in the educational process confirms an increase in active ELC by 1,5 times compared to 2019 (figure 2).

Students rated the ELC on a five-point scale from 0 to 5, according to the proposed criteria: Clarity; Accessibility; Relevant; Creativity; Expediency. The evaluation of the ELC in 2020 compared to 2019 remained almost at the same high level of evaluation (figure 3).

The observed decrease in the assessment of ELC exhibited by students is caused by the creation and simultaneous use of them during a pandemic, in the mode of full distance learning. Among the reasons are: during the transition to distance learning teachers and students experienced technical difficulties (the need to create activities quickly; insufficient level of digital competence of teachers, psychological barriers to using e-learning, sometimes poor access to the Internet). In 2020, teachers began to use the e-learning system in extreme conditions, not all were fully created ELC, some ELC contained only checkpoints for scoring to form a journal of grades, so students objectively more rigorously assessed ELC in the e-learning system already having a large number of ELC for comparison.

The analysis of the evaluated ENC confirms the use of ENC that were filled with content at

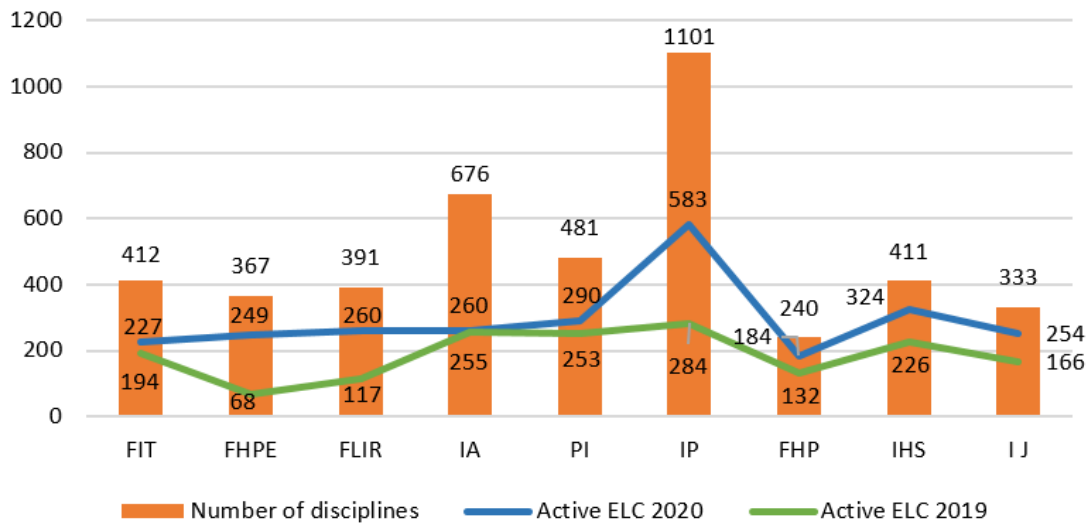

Figure 2: Comparison of the number of active ELC.

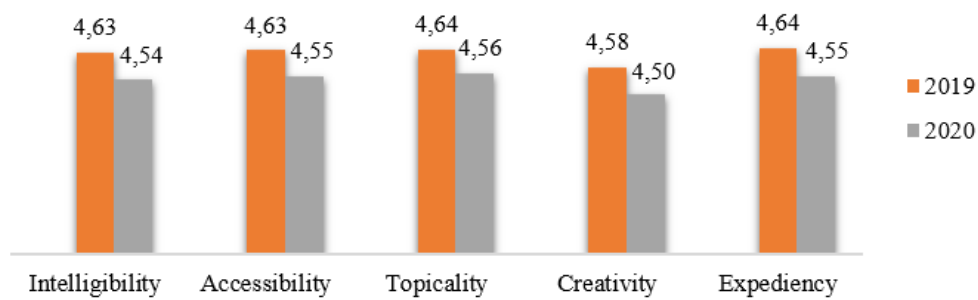

Figure 3: The results of ELC assessment by students.

the same time as the classes, as only 22% of the evaluated ENC were certified and, accordingly, the level of evaluation of such ENC averages 4,6 out of 5,0, which remains at levels of 2019.

According to the results of student assessment, certified ENC are qualitatively developed, the resources presented to them are clear, accessibility; relevant; creativity; expediency and they are sufficient to master the discipline (figure 4).

In 2020, the number of certified ELC has almost doubled compared to 2019, the number of ELC submitted for certification has also increased to 709, which is also twice as high as in 2019 and indicates a positive trend in providing disciplines with certified ELC (figure 5).

The positive trend of increasing the number of certified ELCs confirms the need for them by students and teachers. That is why the introduction of the internal certification system justifies an important role in the preparation of quality educational resources and in general in the modernization of the e-learning system of the University now and in the future.

In particular, the opportunity has already been realized for students in a separate ELC not only

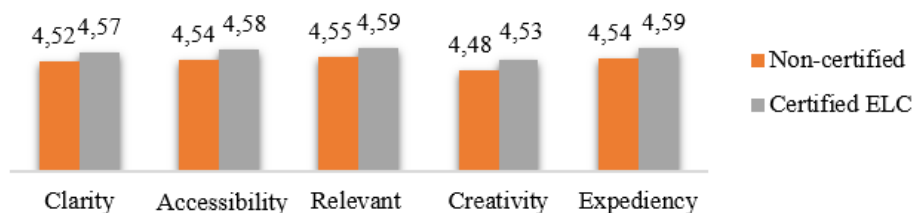

Figure 4: Comparison of assessment of certified and non-certified ELC.

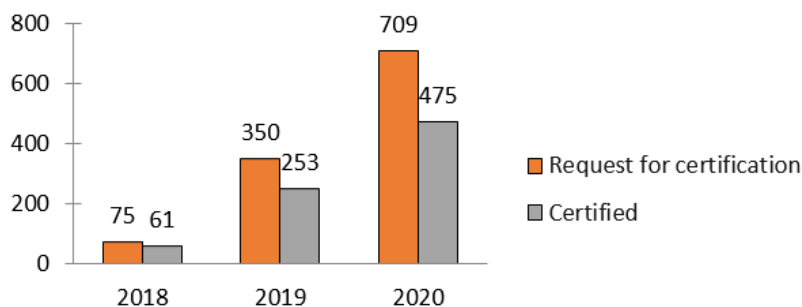

Figure 5: Dynamics of ELC certification.

to have access to educational materials 24/7/365, but also to monitor the progress of personal educational activities. The introduction of the ELC internal certification system has prompted the creation of academic/educational professional programs in the e-learning system, the main advantages of which are the student’s ability to see a list of all disciplines to study during semesters and scores in disciplines (figure 6).

The implementation of academic/educational professional programs in the e-learning system has provided the structuring of the e-learning system, access to educational resources of all disciplines of the curriculum; made it possible to carry out constant monitoring of the provision of academic disciplines with the relevant ELC, the level of their development and certification. It is due to the functioning of the internal certification system that there is an increase in the percentage of quality ELCs that have the status of certified. In the future, it is expected that 100% of all educational programs will be certified by ELC.

Part of the ELC internal certification system is the automated control “Report by the department”, which reflects the percentage of certified ELC, provided by the curriculum in graphical form (figure 7).

When deploying such a report, the e-learning system displays a complete list of names of disciplines for which ELC are developed and used and which of them are certified, which encourages teachers to improve the ELC used and initiate their certification.

The analysis of the results of the implementation of the ELC internal certification system shows its positive impact on the quality of educational resources and the provision of educational services in general.

011.00.03 Corporate education and staff development (2020). Master's degree

Home Dashboard This course Teacher's page Help on ENC

Courses > Pedagogical Institute > Educational programs > 011.00.03 Corporate education and staff development ...

News

- Educational and professional program
- Curriculum

Semester 1

- Sociology of educational needs (credit)
- Andragogy (exam)
- Leadership in education (credit)
- Personnel management (credit)
- Foreign language for professional purposes (without final control)
 - Final control in the 2nd semester
 - Course link
- Organizational psychology and psychology of work (exam)
- Monitoring the educational needs of the corporation (credit)
- Internet and applied information technologies in education (exam)
- Corporate pedagogy and staff development (without final control)
 - Final control in the 2nd semester
 - Course link
- Production practice (methodical) (without final control)
 - Final control in the 2nd semester
 - Course link

Semester 2

- Foreign language for professional purposes (exam)
- Corporate pedagogy and staff development (exam)
- Corporate culture and ethics (credit)

Figure 6: Academic/educational professional programs in the e-learning system.

6. Conclusions

Based on the testing of the pilot model of ELC certification, a system of internal certification of educational resources for blended and e-learning has been developed in University, which can be recommended for implementation in higher education institutions.

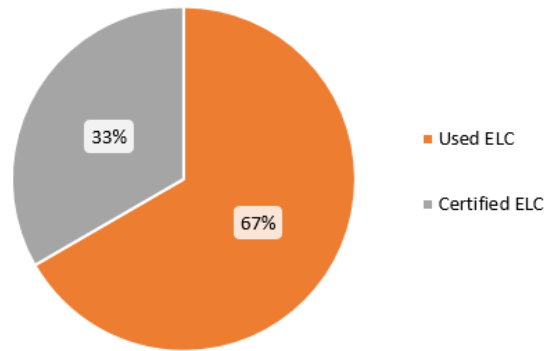

Figure 7: Representation ELC in “Report by the department”.

The three independent and diverse expertise (professional, resource and technical) that underlie the system of internal certification and evaluation of ELC by students ensure high quality educational resources and, as a result, the quality of educational services. In the future, it is planned to achieve 100% ELC certification for all educational programs that train professionals with a sufficient level of digital and professional competence and are competitive in the labor market.

The system of internal certification encourages teachers to increase the level of technical and professional competence, allows them to increase their rating among university teachers; expand the use of digital technologies in the educational process; creation of modern educational digital resources taking into account features of styles of perception of material and designing of criteria of an estimation of their quality; use of digital tools for effective communication and cooperation in blended and e-learning; development of ability and sense of need for constant self-development and self-improvement.

References

- [1] N. Morze, S. Vasylenko, M. Hladun, Ways to improve the motivation of university teachers to develop their digital competence, *Open educational e-environment of modern University* 5 (2018) 160–177. doi:10.28925/2414-0325.2018.5.160177.
- [2] M. Velykodna, Psychoanalysis during the COVID-19 pandemic: Several reflections on countertransference, *Psychodynamic Practice* 27 (2021) 10–28. doi:10.1080/14753634.2020.1863251.
- [3] L. Hrynevych, N. Morze, M. Boiko, Scientific education as the basis for innovative competence formation in the conditions of digital transformation of the society, *Information Technologies and Learning Tools* 77 (2020) 1–26. doi:10.33407/itlt.v77i3.3980.
- [4] L. Hrynevych, L. Ilich, N. Morze, O. Protsenko, V. Proshkin, I. Shemelynets, K. Lynov, H. Rii, Organization of the educational process in Ukrainian schools under quarantine: an analytical note, Borys Grinchenko Kyiv University, Kyiv, 2020. URL: <https://www.irf.ua/wp-content/uploads/2020/09/organizacziya-osvitnogo-proczesu-v-shkolah-ukrayiny-v-umovah-karantynu-2020.pdf>.

- [5] M. S. Abdel-Haq, E. Asfoura, Proposed V-E-learning Model: Applying V-Model to Ensure the Quality of E-Learning System Implementation at Higher Education Institutions (The Case of Dar Al Uloom University - COVID-19 Pandemic Effect), *Turkish Journal of Computer and Mathematics Education* 12 (2021) 1492–1507. doi:10.17762/turcomat.v12i6.2688.
- [6] A. Al-Hunaiyyan, R. Alhajri, A. Bimba, Towards an Efficient Integrated Distance and Blended Learning Model: How to Minimize the Impact of COVID-19 on Education, *International Journal of Interactive Mobile Technologies* 15 (2021) 173–193. doi:10.3991/ijim.v15i10.21331.
- [7] P. Kaewsaiha, S. Chanchalor, Factors affecting the usage of learning management systems in higher education, *Education and Information Technologies* 26 (2021) 2919–2939. doi:10.1007/s10639-020-10374-2.
- [8] R. A. Sultan, A. K. Alqallaf, S. A. Alzarooni, N. H. Alrahma, M. A. AlAli, M. T. Alshurideh, How students influence faculty satisfaction with online courses and do the age of faculty matter, in: A. E. Hassanien, A. Haqiq, P. J. Tonellato, L. Bellatreche, S. Goundar, A. T. Azar, E. Sabir, D. Bouzidi (Eds.), *Proceedings of the International Conference on Artificial Intelligence and Computer Vision (AICV2021)*, volume 1377, Springer International Publishing, Cham, 2021, pp. 823–837. doi:10.1007/978-3-030-76346-6_72.
- [9] Regulations on the procedure for creating e-learning courses, their certification and use in the e-learning system of Borys Grinchenko Kyiv University, 2020. URL: https://kubg.edu.ua/images/stories/Departaments/vdd/documenty/rozdil_7/nakaz_674_29.10.20.pdf.
- [10] O. Buinytska, S. Vasylenko, E-learning to ensure the educational services' quality in university distance learning, in: E. Smyrnova-Trybulska (Ed.), *Innovative Educational Technologies, Tools and Methods for E-learning*, volume 12 of *E-learning*, Studio NOA for University of Silesia in Katowice, Katowice, Cieszyn, 2020, pp. 88–100.
- [11] N. Morze, O. Buinytska, L. Varchenko-Trotsenko, *Creating a modern e-learning course in the MOODLE system*, Kamenets-Podolsky, 2016.
- [12] K. Polhun, T. Kramarenko, M. Maloivan, A. Tomilina, Shift from blended learning to distance one during the lockdown period using moodle: test control of students' academic achievement and analysis of its results, *Journal of Physics: Conference Series* 1840 (2021) 012053. doi:10.1088/1742-6596/1840/1/012053.
- [13] V. Ogneviuk, N. Morze, O. Buinytska, L. Varchenko-Trotsenko, *I am in the digital environment of the university, I am a student*, 9th. ed., Borys Grinchenko Kyiv University, Kyiv, 2020, pp. 117–174.
- [14] O. Buinytska, E-education content management, in: E. Smyrnova-Trybulska (Ed.), *E-learning Methodology – Implementation and Evaluation*, volume 8 of *E-learning*, Studio NOA for University of Silesia in Katowice, Katowice, Cieszyn, 2016, pp. 451–467.
- [15] M. Leshchenko, V. Hrynko, O. Kosheliev, Methods of designing digital learning technologies for developing primary school pre-service teachers' 21st century skills, *CEUR Workshop Proceedings* 2732 (2020) 1028–1043.
- [16] O. Buinytska, S. Vasylenko, Using e-courses to enhance the future teachers' digital competence, *Open educational e-environment of modern university Special edition* (2019) 44–62. doi:10.28925/2414-0325.2019s5.

Strategic learning towards equilibrium. Exploratory analysis and models

Oleksii P. Ignatenko¹

¹*Institute of Software Systems NAS Ukraine, 40 Academician Glushkov Ave., Kyiv, 03187, Ukraine*

Abstract

This paper deals with strategic behavior of people, we observed from experiments. The research question, formulated in this work, is how players (mainly children) learn in complex strategic situations which they never faced before. We examine data from different games, played during popular lectures about game theory and present findings about players progress in strategic learning while competing with other players. Four “pick a number” games were investigated, all with similar-looking rules but very different properties. These games were introduced to very different groups of listeners. The data gathered is available in open repository for replication and analysis. In the work we analyse data and propose the agent-based model of beauty contest game, explaining observed behavior. Finally, we discuss the findings propose hypothesis to investigate and formulate open questions for future research.

Keywords

behavioral game theory, guessing game, k-beauty contest, active learning, R, agent-based modeling

1. Introduction

Game theory is a field of science which investigates decision-making under uncertainty. The source of the uncertainty can be strategic structure, e.g. probability of certain events, lack of information about future possibilities or it can be about decisions of other agents. In last case we can talk about interdependence, that is, when the actions of some players affect the payoffs of others. Such situations arise around us every day and we, consciously or unconsciously, take part in them. The success is heavily relies on our perception about actions of other player. The problem is how we can know future actions of other players. Truth be told we can't, but we can start with some assumptions, that will help eventually create framework, model or theory of “mind”, which will predict future (reasonable) actions. Game theory proposed approach, which is now under questioning (especially from the side of experimental or behavioral economy), nevertheless we will start from standard notions and then will proceed to experimental data.

One can expect that other players will play “reasonably”, and by this game theory means that they will try to achieve a better result in some agent's sense. This idea is grasped by term **rationality**. Every rational player must calculate best possible result, taking into account the

CoSinE 2021: 9th Illia O. Tepytskyi Workshop on Computer Simulation in Education, co-located with the 17th International Conference on ICT in Education, Research, and Industrial Applications: Integration, Harmonization, and Knowledge Transfer (ICTERI 2021), October 1, 2021, Kherson, Ukraine

✉ o.ignatenko@gmail.com (O. P. Ignatenko)

🌐 <https://www.nas.gov.ua/EN/PersonalSite/Pages/default.aspx?PersonID=0000004947> (O. P. Ignatenko)

🆔 0000-0001-8692-2062 (O. P. Ignatenko)

© 2022 Copyright for this paper by its authors.
Use permitted under Creative Commons License Attribution 4.0 International (CC BY 4.0).



CEUR Workshop Proceedings (CEUR-WS.org)

rules of the game, the interests of other participants in other words think strategically. It is well known from theory that rational player will play Nash equilibrium (NE) if there is any, which is very useful in the games where only one unique NE exists. Notion of rationality was indeed fundamental for development of game theory, especially mathematical part. However, the problems with this notion also quite numerous.

First of all, it is very demanding because it actually presuppose that agent has complete, transitive preferences and actually capable to compute equilibrium in given strategic situation. But this is simply not feasible in many real situations (for example we know about NE in chess, but still no one can compute it). Secondly, probably more important, there are many games where NE is poor prediction of actual human behavior. In this paper we investigate some of data from such games and discuss the difference.

All this makes decision making very interesting problem to investigate. This is rich area of research, where theoretical constructions of game theory seems to fail to work and experimental data shows unusual patterns. These patterns are persistent and usually do not depend on age, education, country and other things. During last 25 years behavioral game theory in numerous studies examines bounded rationality (best close concept to rationality of game theory), cognitive distortions and heuristics people use to reason in strategic situations. For example we can note surveys of Crawford et al. [1], Mauersberger and Nagel [2]. Also there is comprehensive description of the field of behavioral game theory by Camerer [3].

We will concentrate on the guessing games, which are notable part of research because of their simplicity for players and easy analysis of rules from game theoretic prospective. In this paper we present results of games played during 2018–2021 years is part of popular lectures about game theory. The audience of these lectures was quite heterogeneous, but we can distinguish following main groups: (1) children at schools (strong mathematical schools, ordinary schools, alternative education schools); (2) students (bachelor and master levels); (3) mixed adults with almost any background; (4) adults with business background; (5) participants of Data Science School; (6) participants of summer STEM camps for children.

We propose framework of four types of games, each presenting one idea or concept of game theory. These games were introduced to players with no prior knowledge (at least in vast majority) about the theory. From the other hand, games have simple formulation and clear winning rules, which makes them intuitively understandable even for kids. This makes these games perfect choice to test ability of strategic thinking and investigate process of understanding of complex concepts during the play, with immediate application to the practice. This dual learning, as we can name it, shows how players try-and-learn in real conditions and react to challenges of interaction with other strategic players. At the last section we build agent-based model using Netlogo environment and analyse its relevance to experiment data.

First we start with some definitions.

1.1. Game theory definitions and assumptions

We will consider games in strategic or normal form in non-cooperative setup. A non-cooperativeness here does not imply that the players do not cooperate, but it means that any cooperation must be self-enforcing without any coordination among the players. Strict definition is as follows.

A non-cooperative game in strategic (or normal) form is a triplet $G = \{\mathcal{N}, \{S_i\}_{i \in \mathcal{N}}, \{u_i\}_{i \in \mathcal{N}}\}$, where:

- \mathcal{N} is a finite set of players, $\mathcal{N} = \{1, \dots, N\}$;
- S_i is the set of admissible strategies for player i ;
- $u_i : S \rightarrow \mathcal{R}$ is the utility (payoff) function for player i , with $S = \{S_1 \times \dots \times S_N\}$ (Cartesian product of the strategy sets).

A game is said to be static if the players take their actions only once, independently of each other. In some sense, a static game is a game without any notion of time, where no player has any knowledge of the decisions taken by the other players. Even though, in practice, the players may have made their strategic choices at different points in time, a game would still be considered static if no player has any information on the decisions of others. In contrast, a dynamic game is one where the players have some (full or imperfect) information about each others' choices and can act more than once. In this work we deal with static repeated games, which means that the same game is played twice (sometimes three times) with the same players.

Agents rationality is very important issue, sometimes it is called full rationality (to differ it from bounded rationality – less restricting notion). When fully rational agent try to find the best action, it usually depends on the action of other self-interest agent. So first agent must form beliefs about second agent's beliefs about beliefs of first agent and so on. Such constructions seems to be too complicated but they in fact are base for the predictions of classical game theory, which assumes all agents to be fully rational.

One quite famous result by Aumann [4] is that for an arbitrary perfect-information extensive-form game, the only behavior that is compatible with (1) common knowledge of rationality, and in particular by (2) each agent best responding to their knowledge is for each agent to play according to the strategy, obtained by the backward induction. Aumann and Brandenburger [5] similarly showed that common knowledge of rationality, the game payoffs, and the other agents' beliefs are a sufficient condition for Nash equilibrium in an arbitrary game.

In this regard, the most accepted solution concept for a non-cooperative game is that of a Nash equilibrium, introduced by John F. Nash [6]. Loosely speaking, a Nash equilibrium is a state of a non-cooperative game where no player can improve its utility by changing its strategy, if the other players maintain their current strategies. Of course players use also information and beliefs about other players, so we can say, that (in Nash equilibrium) beliefs and incentives are important to understand why players choose strategies in real situations.

The NE is the core concept of game theory, but it is differ from experiments and sometimes reality. In some games humans demonstrate convergence to equilibrium, but in others do not. This gap between similarly looking games is slim and not easy to catch. We will consider guessing games as a playground to work with players behavior.

2. Guessing games history

In early 90xx Rosemary Nagel starts series of experiments of guessing games, summarized in [7]. She wasn't the first one to invent the games, they were used during the lectures by different game theory researchers (for example Moulin [8]). In recent work [9] authors provide extensive

research of origins of the guessing game with unexpected links to editor of the French magazine “Jeux & Stratégie” Alain Ledoux, who, as far as it is known today, was the first who used the rules and then publish article about unusual patterns observed [10]. Anyway, work of Nagel [7] was first experimental try to investigate the hidden patterns in the guessing game and in this work framework of k-level models was proposed.

Later, Ho et al. [11] gave the name “p-beauty contest” inspired by Keynes comparison of stock market instruments and newspaper beauty contests.

The beauty contest game (BCG) has become important tool to measure “depth of reasoning” of group of people using simple abstract rules. To begin with we should note that behavioral game theory aims to develop models, which explain human behavior in game-theoretic setup more accurately, based both on experiments and theory [3]. There are two main approaches how to deal with problem of replacing full rationality with bounded rationality. First view is to consider boundedness as error. For example quantal response notion [12] or ϵ -equilibrium [13] assume that agents make an error by choosing not optimal strategy profile. They play near-optimal response, because they do not have capacity to calculate exact best action.

The second approach is to treat bounded rationality as a structural property of an agent’s reasoning process. One of the most prominent class of models from this type is iterative models scheme. They include the k-level reasoning [7, 14], cognitive hierarchy [15] and quantal cognitive hierarchy models [16]. All these models consider boundedness as immanent part of reasoning. Each agent has a non-negative integer level representing the degree of strategic reasoning (i.e., modeling of recursive beliefs) of which the agent is capable. Level-0 agents are nonstrategic—they do not model other agents’ beliefs or actions at all; level-1 agents model level-0 agents’ actions; level-2 agents model the beliefs and actions of level-1 agents; and so forth [17].

In this work we support latter idea, analyzing experimental data to estimate changes in numbers of different levels with learning and teaching process.

2.1. Learning models

Recently, game theorists began to actively research the process of reasoning towards the equilibrium. Two prominent simple learning models are reinforcement and belief learning (e.g., fictitious play). In reinforcement, strategies have numerical attraction levels which are reinforced (increased) when a strategy is chosen and the result is good. Reinforcement is a good model of animal learning but does not gracefully accommodate the fact that people often choose strategies that have not been directly reinforced.

In fictitious play, players form beliefs based on a weighted average of what others have done in the past, and best-respond given their beliefs. Remarkably, weighted fictitious play is equivalent to a generalized reinforcement model in which unchosen strategies are reinforced by the forgone payoffs they would have yielded.

There are a lot of other approaches, we will mention approach which enriches 0-level reasoning [16]. Specifically, they investigate general rules that can be used to induce a level-0 specification from the normal-form description of an arbitrary game.

Also we can note work by Gill and Prowse [18], where participants were tested on cognitive abilities and character skills before the experiments. Then authors perform statistical analysis

to understand the impact of such characteristics on the quality of making strategic decisions (using p-beauty contest game with multiple rounds). In more recent work by Fe et al. [19] even more elaborate experiments are presented. It is interesting that in the mentioned paper experiments are very strict and rigorous (as close to laboratory purity as possible) in contrast to games, played in our research. But in the end of the day the results are not differ very much.

As we know there are not many works about game theory experiments for children. In our previous works [20, 21] we presented data from games with participants of 15-18 years old. There is master thesis by Povea and Citak [22], with study of the the behaviour of children aged 8–11 in a beauty contest game with ten repetitions. Authors found evidence that children are able to play a beauty contest game using not only cognitive skills but also empathy.

To deal with these problems, computer simulation, mainly agent-based modeling ABM, can be used. Agent-based models are essentially a tool to discover patterns in behaviors that emerges from simple rules – micro behavior. Agent-based modeling for guessing game is not very developed area of research, for example see paper by Nichols and Radzicki [23].

3. Experiments setup

We claim that our setup is closer to reality then to laboratory and this is the point of this research: how people learn under real-world situations. All games were played under following conditions:

1. Game were played during the lecture about the game theory. Participants were asked not to comment or discuss their choice until they submit it. However, this rule wasn't enforced, so usually they have this possibility if wanted;
2. Participants were not rewarded for win. The winner was announced (so get some "good feelings"), but no more;
3. During some early games we used pieces of paper and we got some percentage of joking or trash submission, usually very small. Later we have switched to google forms, which is better tool to control submission (for example only natural numbers allowed).
4. Google Forms gives possibility to make multiple submission (with different names), since we didn't have time for verification, but total number of submission allows to control that to some extend.

The aim of this setup was to free participants to explore the rules and give them flexibility to make decision in uncertain environment. We think it is closer to real life learning without immediate rewards then laboratory experiments. Naturally, this setup has strong and weak sides. Lets summarize both.

The strong sides are:

1. This setup allow to measure how people make decisions in "almost real" circumstances and understand the (possible) difference with laboratory experiments;
2. These games are part of integrated approach to active learning, when games are mixed with explanations about concepts of game theory (rationality, expected payoff, Nash equilibrium etc), and they allow participants to combine experience with theory;

Table 1

Summary of first game for id of experiment and type of players. Explanation of columns is in the text

Id	Type	Age	Round	Average	Winning	Zlevel	Median	Count	Irrationality
1	Alternative H	12-14	1	66.7	44.5	69.23	78	13	46.15
1	Alternative H	12-14	2	3.91	2.61	0	3.5	12	0
2	Alternative M	12-14	2	42.82	28.54	23.52	45.0	17	0
2	Alternative M	12-14	2	24.37	16.24	0	26.5	16	0
3	Adults		1	40.57	27.05	31.57	40.0	19	5.26
4	Alternative H	12-14	1	52.54	35.03	63.63	55	11	9.09
4	Alternative H	12-14	2	15.41	10.27	8.33	6	12	8.33
5	Adults		1	22.98	15.32	11.76	17.0	102	0
6	TechSchool	16-18	1	43.41	28.94	35.29	45.0	51	3.92
6	TechSchool	16-18	2	46.5	30.99	35.48	29.0	62	32.25
7	Math lyceum	16-18	1	30.58	20.38	16	27.5	50	2.0
7	Math lyceum	16-18	2	14.26	9.5	5.26	7	57	5.26
8	Math lyceum	15-16	1	37.06	24.71	20.68	33.0	29	3.44
8	Math lyceum	15-16	2	26.20	17.47	10.34	17.0	29	6.89
9	Math lyceum	14-16	1	42.0	27.99	44.44	42.5	18	11.11
9	Math lyceum	14-16	2	23.1	15.39	5.0	19.0	20	0
10	Ordinary school	14-16	1	48.69	32.46	46.15	46.5	26	0
10	Ordinary school	14-16	2	19.78	13.18	0	22.0	23	0
11	DS conference		1	37.25	24.83	28.33	33.0	60	8.33
11	DS conference		2	21.44	14.29	15.78	9.0	57	12.28
12	Students		1	42.40	28.27	33.33	40.0	27	3.7
13	Students		1	27.37	18.24	12.5	25.5	8	0
13	Students		2	8.62	5.74	0	8.5	8	0
14	Math lyceum	14-16	1	41.05	27.37	22.22	35.0	18	11.11
14	Math lyceum	14-16	2	17.23	11.49	5.88	13.0	17	0
15	Adults		1	34.32	22.88	20.73	30.0	82	1.21
15	Adults		2	12.48	8.32	2.19	8.0	91	2.19
16	Adults		1	43.05	28.70	33.96	40.0	53	1.88
16	Adults		2	14.69	9.79	1.88	11.0	53	1.88
17	Adults		1	50.33	33.55	41.66	50.0	12	8.33
17	Adults		2	13.50	8.99	0	12.0	46	0
18	Math lyceum	14-16	1	41.72	27.81	36.36	37.0	11	9.09
18	Math lyceum	14-16	2	26.36	17.57	0	30.0	11	0
19	Math lyceum	14-16	1	29.43	19.62	13.63	25.0	44	0
19	Math lyceum	14-16	2	27.25	18.16	20.45	9.5	44	20.45

3. Freedom and responsibility. The rules doesn't regulate manipulations with conditions. So this setup allows (indirectly) to measure preferences of players: do they prefer cheat with rules, just choose random decision without thinking or put efforts in solving the task.

Weak sides are:

1. Some percentage of players made "garbage" decisions. For example choose obviously worse choice just to spoil efforts for others;

2. Kids has (and often use) possibility to talk out decision with the neighbors;
3. Sometimes participants (especially kids) lost concentration and didn't think about the game but made random choice or just didn't make decisions at all;
4. Even for simplest rules, sometimes participants failed to understand the game first time. We suppose it is due to conditions of lecture with (usually) 30–40 persons around.

3.1. Rules

All games have the same preamble: Participants are asked to choose integer number in range 1 – 100, margins included. Note, that some setups, investigated in references, use range starting with 0. But the difference is small.

To provide quick choice calculation we have used QR code with link to google.form, where participants input their number. All answers were anonymous (players indicate nicknames to announce the winners, but then all records were anatomized). The winning condition is specific for every game.

1. *p-beauty contest*. The winning number is the closest to p of average. Usually $p = 2/3$, but we used other setups as well;
2. *Two equilibrium game*. The winning number is the furthest from the p times average. Usually $p = 1$ if not explicitly mentioned;
3. *Coordination with assurance*. The winning number is the number, chosen by plurality. In case of tie lower number wins;
4. *No equilibrium game*. The winning number is the smallest unique;

All these games are well-known in game theory, let's address paper [21], where all properties are summarized and do not repeat them there.

4. Results and data analysis

In this section we present summary of data, gathered during the games.

4.1. First game

Summary of results of First game is given in the table 1. Columns descriptions are:

- id is the id of experiment;
- type is the type of group. Alternative H and M is for alternative school (not in governmental system) with humanitarian and mathematical direction respectively. Math lyceum goes also for summer camps with participants from different lyceums;
- age is the approximate age of participants, only indicated for children, to distinguish possible borderline between stages of strategic reasoning;
- round is the round of the game;
- average is the average of choices;
- winning number is the average * 0.66;

- zlevel is the percent of players, choosing numbers bigger than 50, it is estimation of 0-level players in this round. As one can expect it is declining with round;
- median is the median of choices (sometimes it is more informative than average);
- count is the number of choices;
- irrationality is the percent of choices bigger than 90.

Almost all winning numbers are fall (roughly) in the experimental margins, obtained by Nagel [7]. With winning number no bigger than 36 and not smaller than 18 in first round. Two exceptions in our experiments were Facebook on-line game (15.3), when players can read information about the game in, for example, Wikipedia. And other is alternative humanitarian school (40.1), where participants seems didn't got the rules from the first time.

4.1.1. Metrics and analysis

First metric to observe is the percent of “irrational choices” - choices that can't win in (almost) any case. Lets explain, imagine that all players will choose 100. It is impossible from practice but not forbidden. In this case everybody wins, but if only one player will deviate to smaller number – he/her will win and others will lose. So playing numbers bigger than 66 is not rational, unless you don't want to win. And here we come to important point, in all previous experiments this metric drops in second round and usually is very low (like less than 5%) [11]. But in our case there are experiments where this metric become higher or changes very slightly. And initially values are much higher than expected. So here we should include factor of special behavior, we can call it “let's show this lecturer how we can cheat his test!”. What is more interesting – this behavior more clear in case of adult than kids.

It is also interesting to see distribution of choices for different types of groups. We can summarize choices on the histograms (figure 1). Using models of strategic thinking we will adopt the theory of k-levels. According to this idea 0-level reasoning means, that players make random choices (drawn from uniform distribution), and k-level reasoning means that these players use best-response for reasoning of previous level. So 1-level reasoning is to play 33, which is best response to belief that average will be 50, 2-level is best response to belief that players will play 33 and so on.

As we can see from the diagram 1, some spikes in choices are predicted very good, but it depends on the background of players. The best prediction is for attendees of Data Science conference, which presumes high level of cognitive skill and computer science background.

On figure 2 we can see boxplots, defined by number of players with different level of perception. Level are defined in next subsection, but we can see pattern of behavior. Number of “irrational” (choices with big numbers) is decreasing, so as “next-to-win-but-bigger” numbers. Number of 2-level reasoning, especially after explanation about the equilibrium concept is growing substantially, while number of “too smart” choices – choices from [1,5] is basically more or less the same.

Interesting hypotheses, that need to be tested in details, can be formulated: **Higher number of choices from [50,100] in first round leads to higher number of choices from [1,5] in second round and vice verse.**

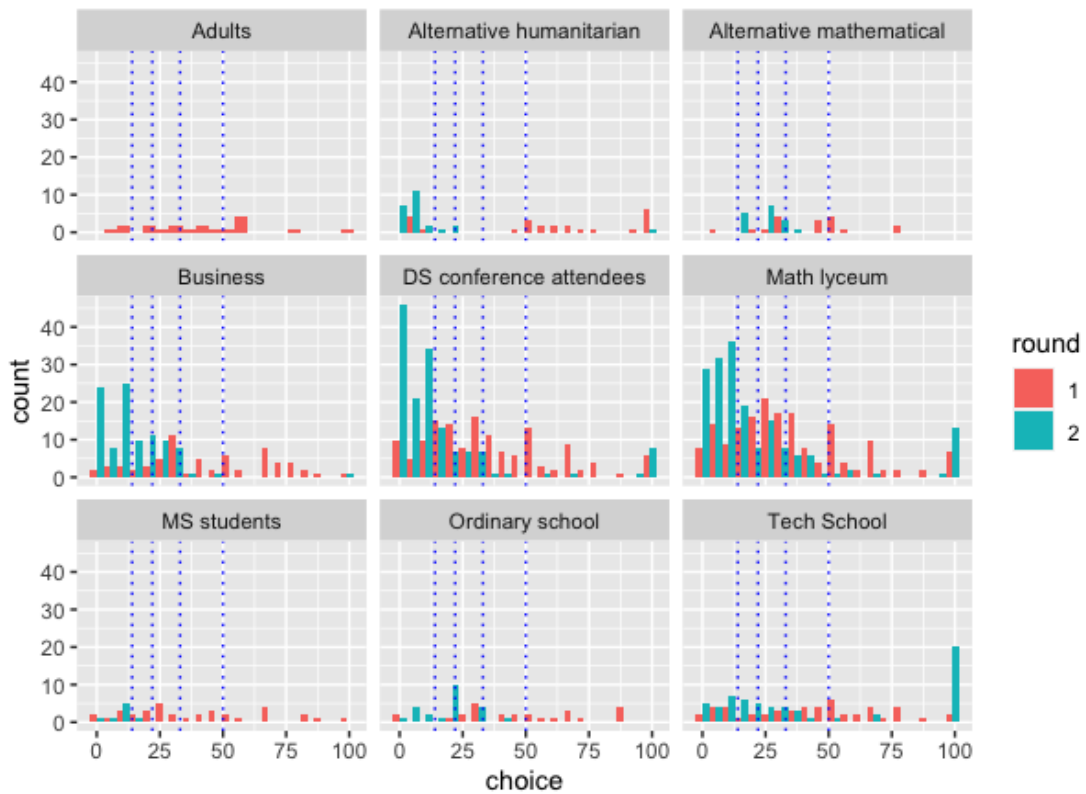

Figure 1: Histogram of choices for each round.

Another metric [24] is how much winning choice in second round is smaller than in first. Due to concept of multi-level reasoning, every player in this game trying to its best to win but can't do all steps to winning idea. So there are players, who just have 0-level reasoning, they choose random numbers. First-level players choose 33, which is best response for players of 0-level and so on. Based on result of first round and, in fact, explanation about the Nash equilibrium, players must know that it is better to choose much lower numbers. But graph shows that decrease is quite moderate. Only students shows good performance in this matter. And tech school shows (small) increase in winning number in second round!

4.1.2. Levels of reasoning analysis

Another point about the process of learning in this game is how players' decisions are distributed over the space of strategies. We claim that there is a distinct difference in changes between first and second round for different groups. To perform this analysis we apply the idea of k-level thinking.

To find differences we need to simplify this approach. First, we define **b-level** players as players who choose numbers from the range [50,100]. It is beginner players, who do not understand rules (play randomly) or do not expect to win or want to lose intentionally (for reasons discussed

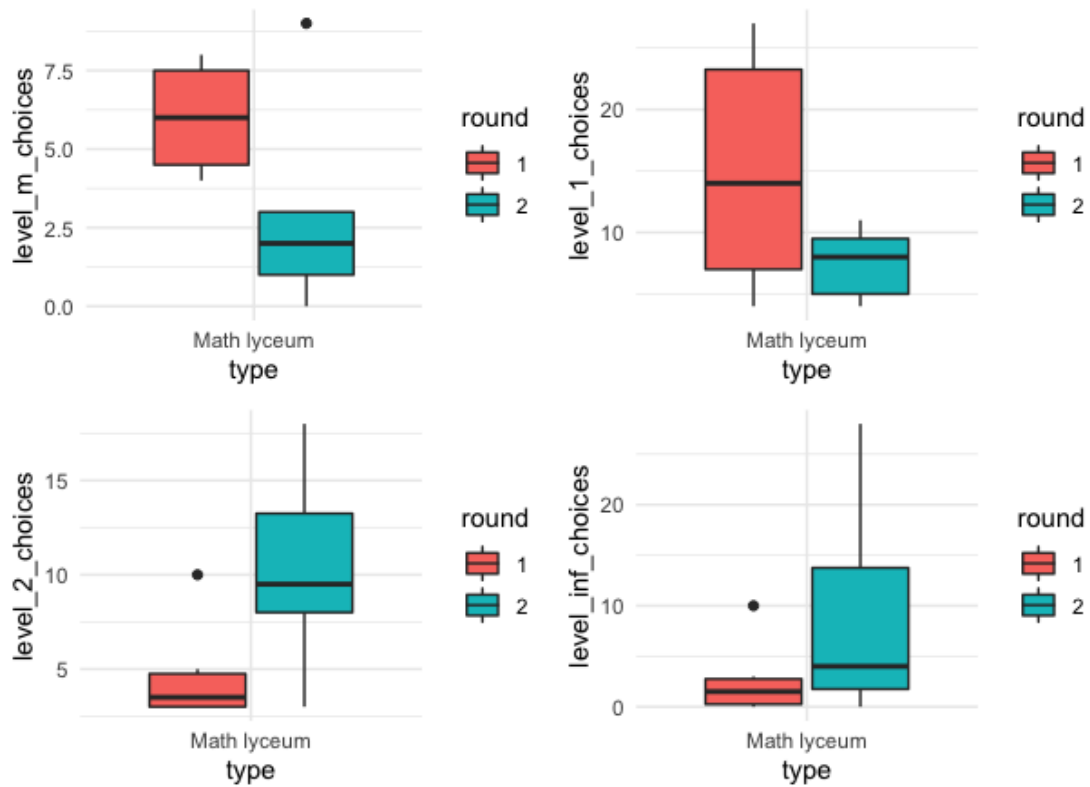

Figure 2: Change in winning number for number of participants.

above). The substantiation for such range is that numbers higher than 50 did not win in any game. Second level we call **m-level**, it is for range [18,50]. It is for players with middle levels of reasoning, usually first round winning number is in this range (and in part of second rounds also).

Third level is **h-level**, it is for range [5, 18]. It is for high level reasoning and finally **inf-level** ([1,5] range) is for “almost common knowledge” level of thinking.

Calculating the number of levels for each game we can estimate change (in percentage of number of players) in adopting different strategy levels.

There are some limitation of this approach:

- number of players changed with rounds, since not everyone participated (it was option, not obligation);
- limits of ranges are not defined by model or data. It can be future direction of research – how to define levels in best way.

Results are presented in table 2.

What conclusions we can draw from this data? There are no clear difference in changing, but at least we can summarise few points:

Table 2
Summary of change in strategy levels

Type	b-difference	m-difference	h-difference	inf-difference
Alternative humanitarian	-72	-8	0	72
Alternative mathematical	-24	-6	30	-6
Alternative humanitarian	-52	0	17	43
Math lyceum	-9	-36	24	34
Math lyceum	-10	-24	28	7
Ordinary school	-49	12	20	4
DS conference attendees	-14	-32	14	27
MS students	-12	-50	50	12
Alternative mathematical	-17	-34	23	23
DS conference attendees	-17	-30	23	35
Business	-32	-17	21	28

- Usually after first round and equilibrium concept explanation there is decrease in **b-level** and **m-level**;
- Symmetrically, there is increase in two other levels, but sometimes it is more distributed, sometimes it is (almost) all for **inf-level**;
- Last situation is more likely to happen in schools, where kids are less critical to new knowledge;
- Usually second round winning choice in the realm of **h-level**, so groups with biggest increase in this parameter are the ones with better understanding.

4.1.3. Size and winning choice

This game is indeed rich for investigation, let us formulate last (in this paper) finding about this game. Can we in some way establish connection between number of players and winning number (actually with strategies, players choose during the game)? To clarify our idea see at figure 3. It is scatter plot of two-dimensional variable, x-axis is for number of participants in the game and y-axis is for winning choice per round. Different colors are for different types of group, where games were played.

As we can observe, first and second rounds form two separate clusters. This is expected and informs us that players learned about the equilibrium concept between rounds and apply it to practice. Also there is a mild tendency that smaller groups have bigger winning numbers. At least variation is bigger.

This is yet too bold to formulate connection between size of the group and winning number, but probably the reason is that when size of the group is bigger, number of “irrational” players increases. It can be due to some stable percentage of such persons in any group or other reasons, but it is an interesting connection to investigate.

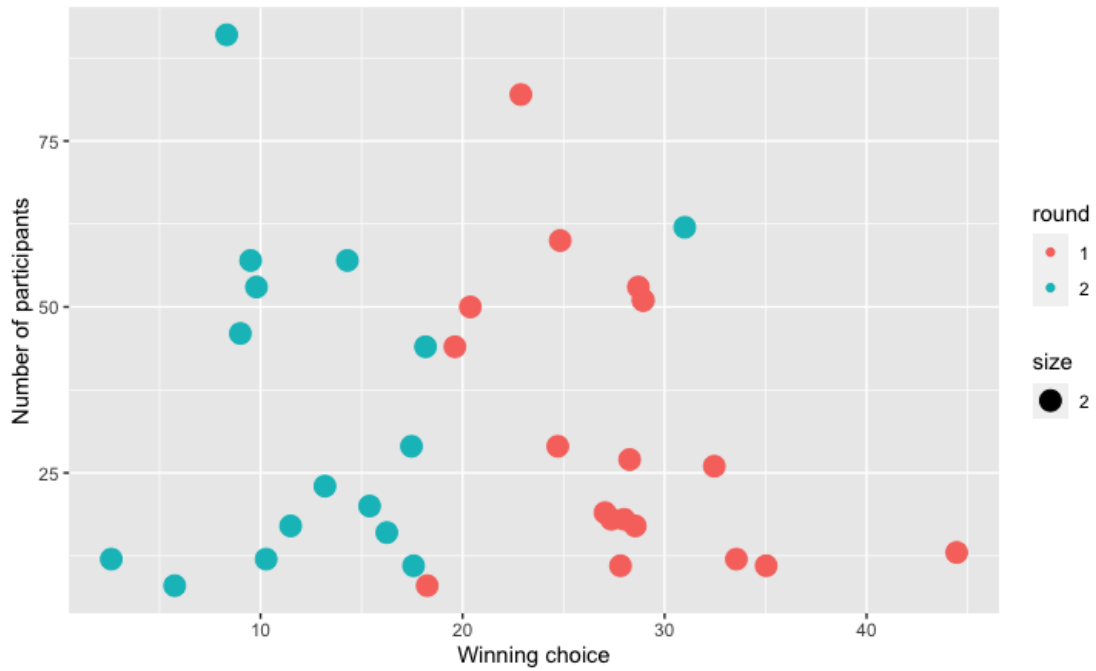

Figure 3: Change in winning number for number of participants.

4.1.4. Intentionally irrational?

Another interesting finding is that after first round finished, after observing result and listening explanation about the NE number of players, who choose over 90 (it is obviously non winning choice) increases. It is actually not accidental, data from [22] also show increase in 2-5 round. We believe that this is quite important part of play. This phenomena especially visible in high school children, with strong math background (usually they has more freedom and self confidence in choosing non-standard strategies).

4.2. Second game

In second game the key point is to understand that almost all strategies are dominated. One can see that average can be bigger or smaller then 50, and accordingly winning choice will be 1 or 100. It is worth to note, that popular nature of these experiments and freedom to participate make the data gathering not easy. For example many participants just didn't take any decision in second game. Results are summarised in the table 2.

We refine players decisions to see how many players made choices with rationalizability (Bernheim [25]), which are best response for some strategy profile of other players. In this game there are only two best responses possible (in pure strategies), literally 1 and 100.

This is remarkable result, players without prior communications choose to almost perfect mixed equilibrium: almost the same percentage choose 1 and 100. This is even more striking taking into account no prior knowledge about mixed strategies and mixed equilibrium, kids

Table 3
Second game. Rationalizable choices summary

Type	Average	Choose 100	Choose 1	Count
Adults	46.5	24.3%	24.34%	115
Alternative mathematical	43.8	25.9%	27.9%	27
Business	50.6	29.3%	29.3%	99
DS conference attendees	37.4	15.8%	36.8%	114
Math lyceum	48.5	22.7%	24.7%	154
Ordinary school	51.2	30.4%	30.4%	23

play it intuitively and without any communication. To illustrate the mixed Nash learning by groups, put dependency of percent of 1 choices and 100 choices on plot.

4.3. Third game

Third game is simpler than first two, it is coordination game where players should coordinate without a word. And, as predicted by Schelling [26], they usually do. Data presented in the [27] shows that 1 is natural coordination point, with one exception – Tech school decided that it would be funny to choose number 69. Probably, it is the age (11th grade) here to blame. Also we can note attempt to coordinate around 7, 50 and 100.

Interesting and paradoxical result, which is expected from general theory, that with fewer options coordination in fact is more difficult. Let's consider, where players' decision was to choose integer from [1,10], only 10 choices. Comparing to previous game with 100 possible choices, coordination was very tricky - two numbers got almost the same result.

4.4. Fourth game

Here we just note, that the winning numbers were: 12, 2, 4, 20. Since no equilibrium here was theoretically found, we can only gather data at this stage and formulate hypothesis to find one.

All experimental data and R file for graphs can be accessed in open repository [27].

5. Agent-based model

The existence of irrational behavior challenges the basic game-theoretic assumption about self-interest and capability to calculate best option. In other words, real people do not think as machines or algorithms. They form hypotheses or expectations using simple rules. These rules are influenced by emotions, social norms and also can be changed depending on feedback (reinforced). This use of inductive reasoning leads to two issues. First, what rules that people follow? Second, suppose we know these rules, how do we model the behavior of many interacting, heterogeneous agents in that situation?

5.1. Netlogo

NetLogo is an environment for agent-based modeling and simulation based on high level programming language. It is a freely available, open-source, multi-platform software.

In Netlogo agents live in 'world' – rectangular grid, where agents of different types can be created. There are four types of agents: patches, turtles, links and the observer. Patches are fixed pieces of "ground" that make the world. Turtles can move through patches in any distance/direction at every step of time. Links have the function of connecting at least two agents, and are represented by lines. The observer is the overseeing agent that gives other agents instructions and makes changes in the world. It is responsible for holding a set of global variables.

The time passes as discrete steps called ticks, in which all agents can behave.

5.2. Model

Epstein [28] defines following characteristics of agent-based model: (1) heterogeneity – agents are different in some ways; (2) autonomy – each agent make own decisions; (3) explicit space – agents interact in a given environment; (4) local Interaction – agents generally interact with their neighbors and immediate environment; (5) bounded Rationality – agents have limited information and computing power; agent behavior is generated by simple rules that may adapt over time; (6) non-equilibrium dynamics.

As a first step to build model of guessing games players we propose agent-based model (it can be downloaded from the repository with experimental data) with characteristics 1, 2, 5. The structure of model is following. Agents have properties – level, irrationality, choice. Level is their current level of understanding, irrationality is the flag variable, which includes possible irrational behavior and choice is the current number choice. Setup procedure allows to create different distributions of initial levels and p is the game multiplier. On each step every agent chooses number according to simple rules. The code is downloaded on github, here we just informally explain the main idea. Level of agent defines the number - agents with level 0 choose randomly from $[1,100]$, level 1 choose from $[45,55]$ and so on. Margins are adjustable and will be tuned by real data in future work. After the round winner is determined, and each player with choice bigger than winning number increase its level of understanding. In this model we consider only five levels, where level 5 means common knowledge, when player chooses 1.

When no irrationality is in the model we can observe typical convergence to equilibrium 4 left and this is stable pattern.

But as we already know from the experiments it is not what we can observe in real life. So irrational behavior was included to meet pattern from data.

Irrationality in our model implemented as 'anger', when player who is currently a loser sometimes goes to irrational mode and chooses 100 in one next round. This leads to interesting pattern (figure 4, right), when sometimes winning number increasing in second round, but nevertheless convergence to equilibrium is inevitable.

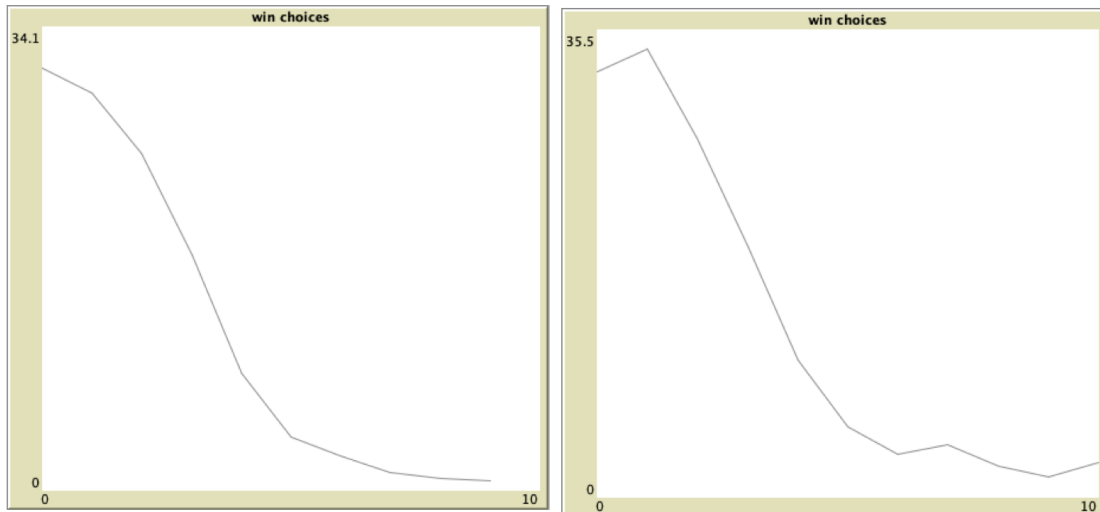

Figure 4: Plots of players win choice over round.

6. Conclusions

In this paper we have presented data of experiments, analysis and explanation of patterns and agent-based model, which can be calibrated in future. We were able to confirm existence of pattern in decision making – every group behave in almost the same way dealing with unknown strategic situation. We also found some deviation and this is interesting point of difference with more “laboratory” setup of existing research. Also we build agent-based model and show how simple rules could lead to complex behavior of players.

The main findings of the paper are following:

1. To learn the rules you need to break them. Participants have chosen obviously not winning moves (> 66) partly because of new situation and trouble with understanding the rules. But high percent of such choices was present in second round also, when players knew exactly what is going on. This effect was especially notable in the cases of high school and adults and almost zero in case of special math schools and kids below 9th grade. We can formulate hypothesis that high school is the age of experimentation when children discover new things and do not afraid to do so.
2. If we considered winning number as decision of a group we can see that group learning fast and steady. Even if some outliers choose 100, mean still declines with every round. It seems that there is unspoken competition between players that leads to improvement in aggregated decision even if no prize is on stake. Actually, it is plausible scenario when all participants choose higher numbers. But this didn't happen in any experiment. The closest case – Tech school, when bunch of pupils (possible coordinating) switch to 100 still only managed to keep mean on the same level.
3. Still it seems that there is stable percent of people, who choose about 100 and it is not about learning how to play the game. We think that this is something like -1 level of

- reasoning, when player intentionally play “bad move” and this is essential part of model. If we neglect such persons and their motivation, our model will not be correct.
4. agent-based model is the key element to computational analysis of game theory models. We create model with simple rules, which shows close to reality behavior. Now we can simulate different rules and understand limitation of the model.

References

- [1] V. P. Crawford, M. A. Costa-Gomes, N. Iriberry, Structural models of nonequilibrium strategic thinking: Theory, evidence, and applications, *Journal of Economic Literature* 51 (2013) 5–62. doi:10.1257/jel.51.1.5.
- [2] F. Mauersberger, R. Nagel, Levels of reasoning in keynesian beauty contests: a generative framework, in: C. Hommes, B. LeBaron (Eds.), *Handbook of Computational Economics*, volume 4 of *Handbook of Computational Economics*, Elsevier, 2018, pp. 541–634.
- [3] C. F. Camerer, *Behavioral game theory: Experiments in strategic interaction*, The Roundtable Series in Behavioral Economics, Princeton University Press, 2003.
- [4] R. J. Aumann, Backward induction and common knowledge of rationality, *Games and Economic Behavior* 8 (1995) 6–19. doi:10.1016/S0899-8256(05)80015-6.
- [5] R. Aumann, A. Brandenburger, Epistemic conditions for nash equilibrium, *Econometrica* 63 (1995) 1161–1180. URL: <http://www.jstor.org/stable/2171725>.
- [6] H. W. Kuhn, J. C. Harsanyi, R. Selten, J. W. Weibull, E. Van Damme, J. F. Nash Jr., P. Hammerstein, The work of john nash in game theory, *Journal of Economic Theory* 69 (1996) 153–185. doi:10.1006/jeth.1996.0042.
- [7] R. Nagel, Unraveling in guessing games: An experimental study, *The American Economic Review* 85 (1995) 1313–1326. URL: <https://www.cs.princeton.edu/courses/archive/spr09/cos444/papers/nagel95.pdf>.
- [8] H. Moulin, *Game theory for the social sciences*, 2nd ed., New York Univeristy Press, New York, 1986.
- [9] R. Nagel, C. Bühren, B. Frank, Inspired and inspiring: Hervé Moulin and the discovery of the beauty contest game, *Mathematical Social Sciences* 90 (2017) 191–207.
- [10] A. Ledoux, Concours résultats complets. Les victimes se sont plu à jouer le 14 d’atout, *Jeux & Stratégie* 2 (1981) 10–11.
- [11] T.-H. Ho, C. Camerer, K. Weigelt, Iterated dominance and iterated best response in experimental “p-beauty contests”, *The American Economic Review* 88 (1998) 947–969.
- [12] C. F. Camerer, T.-H. Ho, J.-K. Chong, Sophisticated experience-weighted attraction learning and strategic teaching in repeated games, *Journal of Economic theory* 104 (2002) 137–188.
- [13] K. Leyton-Brown, Y. Shoham, *Essentials of game theory: A concise, multidisciplinary introduction*, *Synthesis lectures on artificial intelligence and machine learning* 2 (2008) 1–88. doi:10.2200/S00108ED1V01Y200802AIM003.
- [14] M. Costa-Gomes, V. P. Crawford, B. Broseta, Cognition and behavior in normal-form games: An experimental study, *Econometrica* 69 (2001) 1193–1235.
- [15] C. F. Camerer, T.-H. Ho, J.-K. Chong, A cognitive hierarchy model of games, *The Quarterly Journal of Economics* 119 (2004) 861–898. doi:10.1162/0033553041502225.

- [16] J. R. Wright, K. Leyton-Brown, Predicting human behavior in unrepeated, simultaneous-move games, *Games and Economic Behavior* 106 (2017) 16–37.
- [17] J. R. Wright, K. Leyton-Brown, Models of level-0 behavior for predicting human behavior in games, *CoRR abs/1609.08923* (2016). [arXiv:1609.08923](https://arxiv.org/abs/1609.08923).
- [18] D. Gill, V. Prowse, Cognitive ability, character skills, and learning to play equilibrium: A level-k analysis, *Journal of Political Economy* 124 (2016) 1619–1676. doi:10.1086/688849.
- [19] E. Fe, D. Gill, V. L. Prowse, Cognitive skills, strategic sophistication, and life outcomes, Working Paper Series 448, The University of Warwick, 2019.
- [20] O. Ignatenko, Guessing games experiments in school education and their analysis, *CEUR Workshop Proceedings* 2732 (2020) 881–892.
- [21] O. P. Ignatenko, Guessing games experiments in Ukraine. Learning towards equilibrium, in: S. Semerikov, V. Osadchyi, O. Kuzminska (Eds.), *Proceedings of the Symposium on Advances in Educational Technology, AET 2020*, University of Educational Management, SciTePress, Kyiv, 2022.
- [22] E. Povea, F. Citak, Children in the beauty contest game: behaviour and determinants of game performance, Master’s thesis, Norwegian School of Economics, 2019. URL: <https://openaccess.nhh.no/nhh-xmlui/handle/11250/2611651>.
- [23] M. W. Nichols, M. J. Radzicki, An Agent-Based Model of Behavior in “Beauty Contest” Games, Working Paper 07-010, University of Nevada, 2007.
- [24] W. Güth, M. Kocher, M. Sutter, Experimental ‘beauty contests’ with homogeneous and heterogeneous players and with interior and boundary equilibria, *Economics Letters* 74 (2002) 219–228. doi:10.1016/S0165-1765(01)00544-4.
- [25] B. D. Bernheim, Rationalizable strategic behavior, *Econometrica* 52 (1984) 1007–1028.
- [26] T. C. Schelling, *The Strategy of Conflict: With a New Preface by The Author*, Harvard University Press, 1980.
- [27] O. P. Ignatenko, Data from experiments, 2021. URL: <https://github.com/ignatenko/GameTheoryExperimentData>.
- [28] J. M. Epstein, Agent-based computational models and generative social science, *Complexity* 4 (1999) 41–60.

Some ways of increasing the efficiency of teaching data structures

Zarema S. Seidametova

Crimean Engineering and Pedagogical University, 8 Uchebnyi per., Simferopol, 95015, Crimea

Abstract

Nowadays computer modeling and simulation are widely used in computer science education. There are several ways of increasing the efficiency of the educational process. One of such ways is visualization, the other way is flipped classroom concept. The study aims to present some ways of increasing the efficiency of teaching data structures (hashing, trees) during the Algorithms and data structures course. We conducted two experiments with four study groups of two subjects of the Algorithms and Data Structures – (1) Hashing, (2) Trees (BST, RBT, AVL), – taught second-year bachelor students. In the first experiment, study groups were prepared on the subjects (1) and (2) by the same level of teaching technique with or without visualization tools. Unlike the first experiment, in the second experiment, we used flipped classroom concepts for one study group and a standard way of teaching for another group.

Keywords

computer science education, algorithms, data structure, visualization, flipped classroom

1. Introduction

Computer modeling and simulation has become a widely used tool for solving real-world problems, for training and research on human-computer interaction with complex work and different environments. A simulation is defined as a working representation of reality [1] and can be an abstracted, simplified, or accelerated model of a process or system. Computer modeling and simulation allow exploration cases even if reality is too expensive, complex, or dangerous [1]. For purpose of appropriately using computer modeling and simulation, we need to prepare students to develop and operate with such applications.

Many concepts of computer science and software engineering are difficult for students to understand. Algorithms and Data structures are one of the most important subjects in Computer Science, which is required by all programmers. Programmers need to know how to handle the data in huge quantities, how the data should be stored in the memory and how the memory should be used efficiently. We search the effective ways for implementing pedagogical tools and approaches for proper demonstration of important concepts of algorithms and data structures.

CoSinE 2021: 9th Illia O. Teplytskyi Workshop on Computer Simulation in Education, co-located with the 17th International Conference on ICT in Education, Research, and Industrial Applications: Integration, Harmonization, and Knowledge Transfer (ICTERI 2021), October 1, 2021, Kherson, Ukraine

✉ z.seidametova@gmail.com (Z. S. Seidametova)

🌐 <http://cepulib.ru/index.php/ru/resursy/personalii/47-s-personalii/169-sejdametova-zarema-sejdalievna> (Z. S. Seidametova)

🆔 0000-0001-7643-6386 (Z. S. Seidametova)

© 2022 Copyright for this paper by its authors.
Use permitted under Creative Commons License Attribution 4.0 International (CC BY 4.0).

 CEUR Workshop Proceedings (CEUR-WS.org)

Lee and Lee [2], Knutas et al. [3], Ling et al. [4] discuss the flipped classroom methods for programming courses and promoting student engagement using this method for ordinary or large-scale courses.

The topics of team-based learning and other trends in higher education are considered by Vlachopoulos et al. [5], Burbules et al. [6]. Chang et al. [7] examine the difference in student motivation during data structure courses conducted with the visual programming language and Java.

Karavirta et al. [8], Budiman et al. [9, 10], Stasko [11], Ševčíková and Milková [12] describe the taxonomy of algorithm animation languages, multimedia applications for data structure visualization, and tools for visualizing contents media of data structure courses for mobile learning. Wang [13] proposes a public computer lab management system with four functional parts that provide a convenient and efficient way for the teachers and students to communicate and improves the management level of a public computer lab.

The flipped classroom approaches presented by Tyler and Abdrakhmanova [14], Peethambaran et al. [15], Bikanga Ada [16], Hossain [17], Hendrik and Hamzah [18]. These studies show the effectiveness of flipped classrooms in a wide range of subjects like Engineering, Education Technology, Mathematics, and Statistics, etc. The studies also show the effectiveness of flipped classrooms in programming courses. These studies also found that the flipped classroom method facilitated learning, helped students to develop soft and hard skills, improved students' innovative consciousness and attitudes.

There are other pedagogical approaches that can be used in teaching. Mutua et al. [19], Šimoňák [20, 21, 22, 23], Šimoňák and Benej [24], Supli et al. [25], Mocinecová and Steingartner [26] described different algorithm visualization platforms that can be divided as web, mobile and desktop applications.

To study this problem, we use such methods as a literature review, own experience in teaching algorithms and data structures, tasks, tests, statistical analysis, etc.

2. Algorithms and Data Structures learning roadmap

Algorithms and Data structures are really important courses for every concept used in computer science and software engineering. There are many concepts involved in the subjects of Algorithms and Data structures. There will be many questions for educators like how to learn Algorithms and Data structures, as there are many concepts involved without getting confused during attending the course. For teaching the one-semester course “Algorithms and Data structures” we used the third edition of the fundamental classic CLRS book [27].

The roadmap of teaching and learning and Data structures we define as two main parts presented in schemes on figure 1 (part 1 – Algorithms) and figure 2 (part 2 – Data structures). Part 1 includes such topics as:

- Algorithms analysis technics – asymptotic analysis and notations, Big-Oh, complexities of algorithms, worst, average, best cases of algorithm performing, recurrences, master theorem for solving some types of recurrence equations;
- Sorting algorithms with comparisons – bubble sort, selection sort, insertion sort, merge sort, heap sort, quicksort;

- Sorting algorithms without comparisons (in linear-time) – bucket sort, counting sort, radix sort;
- Searcher algorithms – linear search, binary search, jump search.

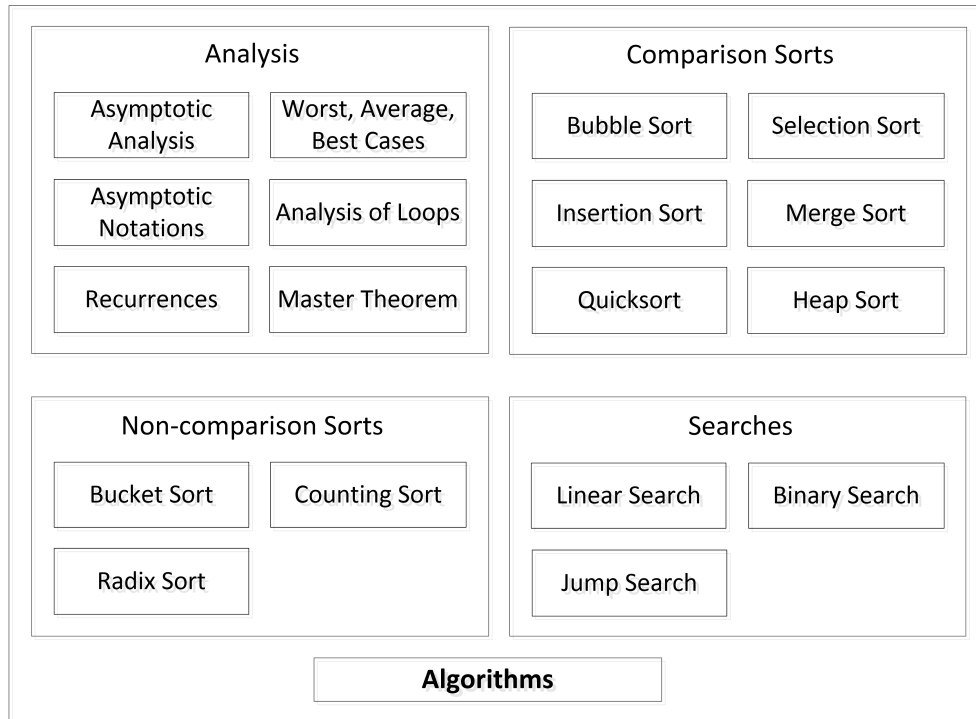

Figure 1: Algorithms learning roadmap.

Part 2 includes data structures topics:

- Linear data structures – array, stack, queue, linked list;
- Non-linear data structures – hashing (direct hash tables, collisions, open addressing, double hashing, perfect hashing), trees (BST, RBT, AVL), graphs, heaps;
- Augmented data structures.

Algorithms and Data structures are used to design an efficient algorithm, organize data access, and economize the execution time of programs. Data structures are widely used in operating systems, database management systems, statistical soft-ware, compiler design, numerical analysis, and artificial intelligence simulations. Algorithms and Data structures play a significant role in the computer science and soft-ware engineering domain. The course of algorithms and data structure introduces the basic data type, such as byte and character string, and presents collective data types, linked lists, stacks, arrays, queues, trees, heaps, and priority queues and complex data structures and, and focuses on programming methodologies, problem-solving strategies, and algorithm development.

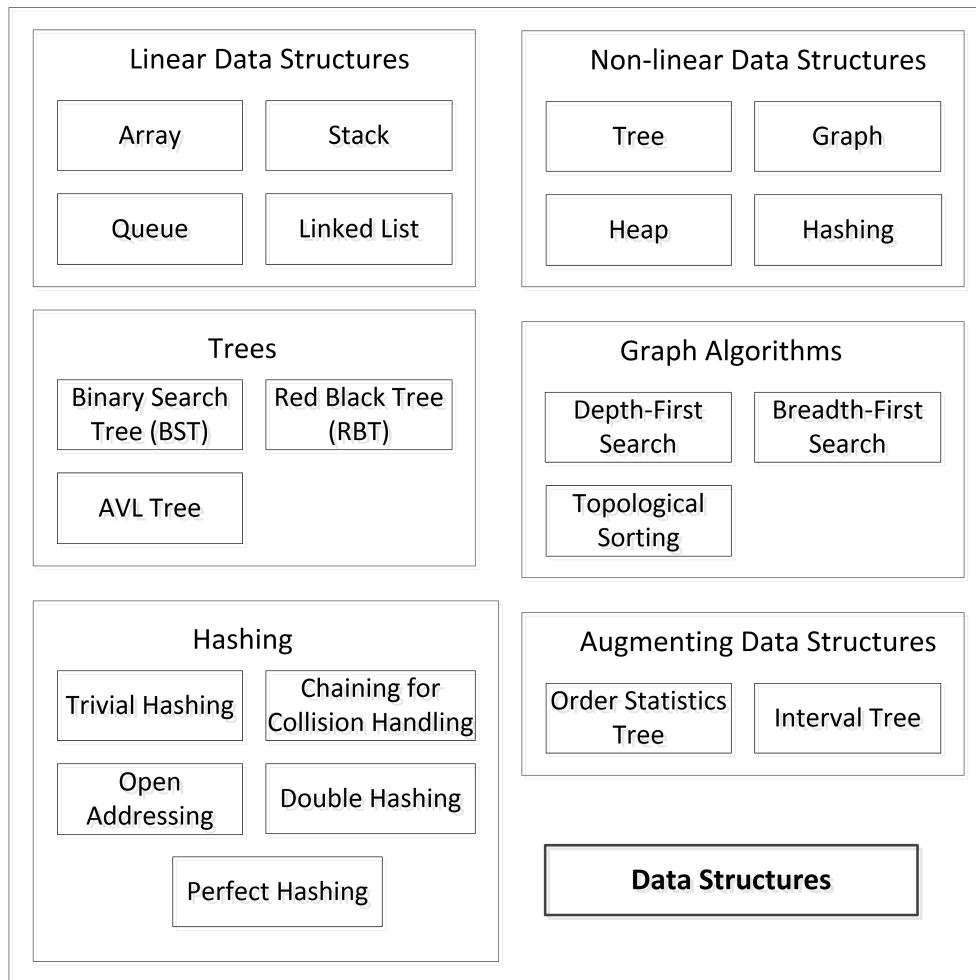

Figure 2: Data Structures learning roadmap.

The algorithms and data structures courses are typically conducted with lectures with homework, labs, and projects. Students are asked to learn algorithms implementation, data structures representations. However, students often have misconceptions. Without proper knowledge of the many classical algorithms and data structures considered in the course, it is difficult for students to understand when best to use which data structures. Such approach with the in-class lecture was mostly teacher-centered and student-teacher interaction in the class was not enough.

To find more effective ways of teaching algorithms and data structures we considered different approaches – visualization and flipped classroom concept. We decided to compare the effect on students learning results of using both approaches. The results of our research are presented in the last section. We chose Hashing and Trees topics for our research study.

The main problem of hashing, studied in the classical course Algorithms and Data Structures includes the following topics: hash tables (a generalization of an array representation), direct

addressing (using an array, the size of which is comparable to the number of actual keys stored in it), resolving possible collisions (avoiding cases of different keys entering the same slot), constructing hash functions (there are a large number of implementation options), open addressing (collision resolution method), universal and ideal hashing (used to maintain $O(1)$ time in the worst case for a statistical set of keys when performing dictionary operations).

Binary Search Trees (BST) support operations: queries – tree traversal, finding the minimum by value, finding the maximum by value, finding the next by value, finding the previous by value, finding a node with a given key value, and operations that update BST – Insertion and Removal of a Node. When studying these operations, it is necessary to draw the attention of students to the peculiarities of performing these operations, as well as the peculiarities of inserting and removing nodes. When deleting nodes, students need to consider all three possible deletion scenarios.

Red and Black Trees (RBT) are challenging enough for students to learn. RBT is a binary search tree that has an additional field `color` (red or black) and obeys the red-black properties (RB properties):

- each node is either red or black;
- tree root and leaves (`nil[T]`) are black;
- if the node is red, then both child nodes are black;
- for each node, all paths from it to the leaves, descendants of this node, contain the same number of black nodes.

The color field and RB properties allow the tree to be balanced. Query operations in the RB-tree are performed in the same way as in the BST. Structure-altering operations, INSERTs, and DELETEs can violate RB properties and require balancing. In the case of RB trees, the ROTATE operation is used to restore the RB property. In codes, the rotation operation is implemented by redesignating node pointers.

Another example of a balanced binary search tree that we recommend to study with students is AVL trees, which for balancing are supplemented with a node height parameter (or store the value of the difference in heights of the left and right subtrees, i.e., one of the values -1, 0, +1), and also obey the property of the AVL tree: the value of the left and right subtrees of any node should not differ by more than 1. The operations supported by AVL trees are the same as in the BST (binary search tree), RBT (red-black trees). Searching for the smallest (MIN), largest (MAX), next, and preceding element by value, searching for a node with a given key – are performed according to the same algorithms as in BST. The operations of inserting and deleting a node are first performed, as in the binary search tree, but then it is necessary to check whether the AVL property is violated. After that, it is necessary to carry out balancing.

Flipped classroom approach has become popular in education in recent decades. The flipped classroom is a student-centered pedagogical approach in which the typical course lecture and homework are reversed. Successful flipped classroom implementation involves not just having lecture videos available before class.

The algorithms and data structures course lasts 18 weeks over a semester. The class meets twice a week. We chose two topics of data structures – Hashing and Trees – for using flipped classroom concept. Each week, we recorded the lecture in several 15-to-30-minute videos. The

lecture videos are made available on Moodle before the in-class lecture. Students were instructed to watch the lecture videos before coming to class each week. In a class, face-to-face meeting, students are given worksheets, which ask students to practice the topics of data structures presented in the lecture videos each week. At the end of class, the worksheets are checked for completeness and returned to the students. Students are encouraged to help answer any questions by a teacher, to discuss, and to work out the tasks on the worksheets together with other students.

The same two topics – Hashing and Trees – we chose for implementing the visualization approach. There are a lot of algorithms and data structures visualization systems available. And it is not easy to find tools that fully meet the needed requirements. As a tool of visualization, we chose the visualization modules suggested by `Mathematica 12.0` that include visualization features of hashing and trees.

Algorithms and data structures visualization can be seen as a valuable supporting pedagogical tool, used as an addition to standard classical ways of education in the field of computer science and software engineering.

Šimoňák [23] concludes, that studies in which students only viewed visualizations, usually did not indicate significant learning advantages over students using conventional learning materials. It can mean that using visualizations does not guarantee students' better understanding of algorithms.

3. Experiments and results

We conducted two experiments with four study groups of the two subjects of the Algorithms and Data Structures – (1) Hashing, (2) Trees (BST, RBT, AVL), – taught second-year bachelor students. In the first experiment, we had two study groups (A1, B1). These study groups were prepared on the subjects (1) and (2) by the same level of teaching technique (same level of explanation by the same teacher using the traditional approach). The difference was that that group A1 used visualization tools while group B1 did not apply such tools. We divided both groups as A1_h, B1_h when we collected results of experiment 1 on the “Hashing” topics, A1_t, B1_t – in case then students were learning “Trees” topics.

The second experiment involved two groups – A2, B2. They also studied Hashing (A2_h, B2_h) and Trees (A2_t, B2_t) topics. Unlike the first experiment, in the second experiment, we used flipped classroom concept for group A2 as a pedagogical approach. Study group B2 was prepared by the same teacher in a standard way using the whiteboard.

In the first experiment, the number of students in group A1 was 28, group B1 had 26 students. In the second experiment, the number of students in group A2 was 31, the number of students in group B2 was 25.

The tests at the end of studying topics of subjects (1) Hashing, (2) Trees (BST, RBT, AVL) consisted of four questions (0.5 points each) and were provided using a free and open-source learning management system Moodle and Google Forms. The results of the tests by groups and topics are shown in figures 3 (for experiment 1) and 4 (for experiment 2).

In both experiments questions on Hashing were selected from the set of questions from trivial hashing, chaining for collision handling, open addressing, double hashing, perfect hashing. For

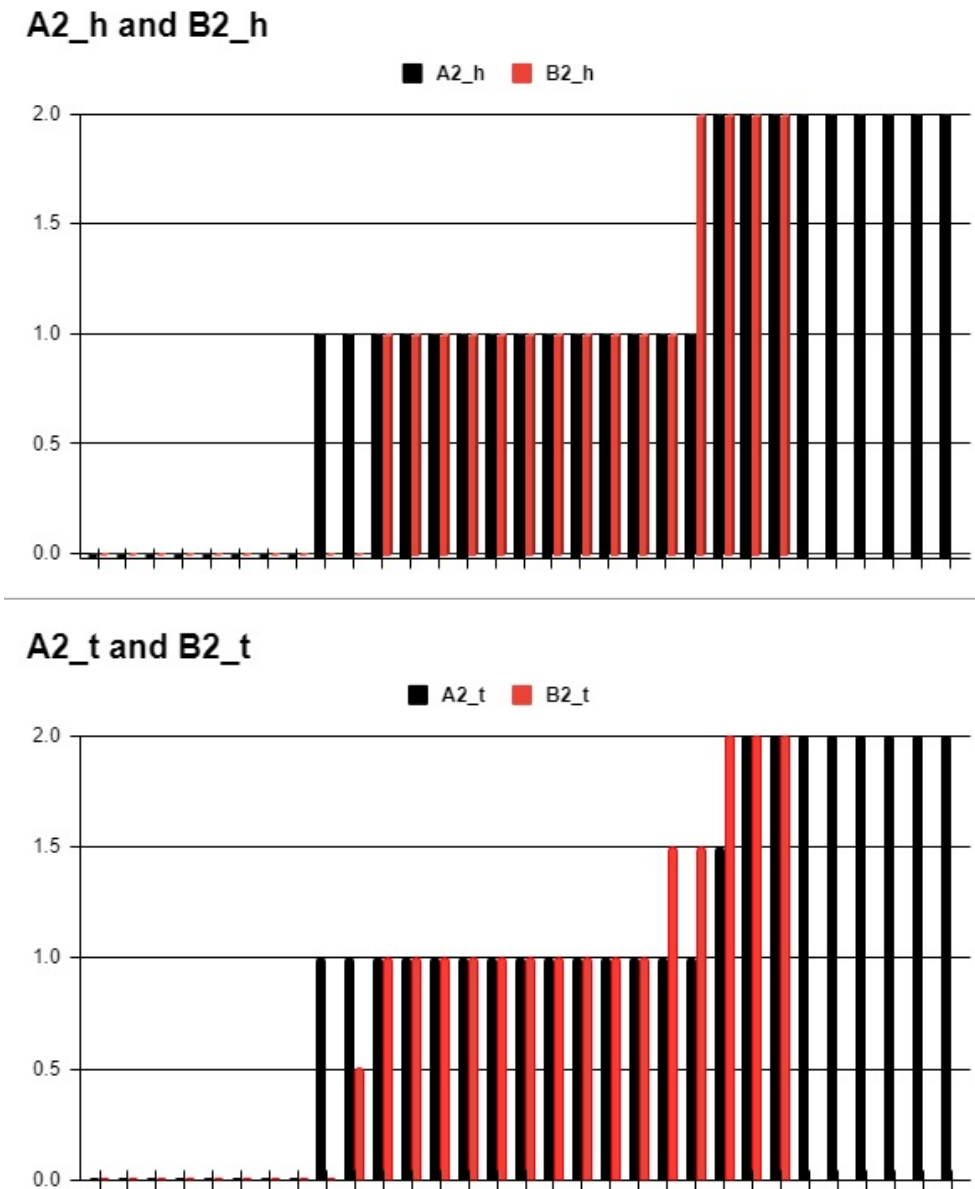

Figure 4: Scores were achieved by students in the second experiment.

0.769 points for B1_h and B1_t.

The total scores achieved by students from group A2 on Hashing (A2_h) and Trees (A2_t) were 32 and 31.5 respectively. Average scores within the group A2 on Hashing (A2_h) and Trees (A2_t) were approximately 1.032 points and 1.016 points respectively. The total scores for group B2 on Hashing (B2_h) and Trees (B2_t) were 19 and 19.5 respectively. Average scores in group B2 were approximately 0.760 points for B2_h and 0.780 for B2_t.

Results of the first and second experiments are presented in table 1. From the results we can conclude the following:

- In the first experiment, group A1 that used visualizations achieved better results. In the case of topic (1) Hashing the difference in average score was 1.071 vs. 0.769, with a standard deviation of 0.766 and 0.710 respectively. In the case of topic (2) Trees, the difference in average score was 0.786 vs. 0.769, with a standard deviation of 0.630 and 0.667 respectively. Thus, the result for the topic (1) was much better for group A1 than for group B1. The result for the topic (2) was almost the same for both groups A1 and B1.
- In the second experiment, group A2 that used flipped classroom concept achieved better results. In the case of topic (1) Hashing the difference in average score was 1.032 vs. 0.760, with a standard deviation of 0.752 and 0.723 respectively. In the case of topic (2) Trees, the difference in average score was 1.016 vs. 0.780, with a standard deviation of 0.723 and 0.693 respectively. Thus, the result for topics (1) and (2) was much better for group A1 than for group B1.

Table 1
Statistical results of experiments

	Experiment 1: Visualization				Experiment 2: Flipped classroom			
	Hashing		Trees		Hashing		Trees	
	A1_h	B1_h	A1_t	B1_t	A2_h	B2_h	A2_t	B2_t
Number of students	28	26	28	26	31	25	31	25
Total score	30	20	22	20	32	19	31.5	19.5
Average	1.071	0.769	0.786	0.769	1.032	0.760	1.016	0.780
Variance	0.587	0.505	0.397	0.445	0.566	0.523	0.541	0.481
Standard deviations	0.766	0.710	0.630	0.667	0.752	0.723	0.736	0.693

4. Conclusions

There are a lot of approaches to the implementation of some ways of increasing the efficiency of teaching data structures (hashing, trees). We conducted two experiments with four study groups of two subjects of the Algorithms and Data Structures – (1) Hashing, (2) Trees (BST, RBT, AVL), – taught second-year bachelor students. In the first experiment, study groups were prepared on the subjects (1) and (2) by the same level of teaching technique with or without visualization tools. Unlike the first experiment, in the second experiment, we used flipped classroom concept for one study group and a standard way of teaching for another group.

Flipped classroom and visualization as pedagogical tools can be used to teach students the necessary skills and competencies in algorithms and data structures.

References

- [1] D. Ifenthaler, Computer simulation model, in: Encyclopedia of the Sciences of Learning, Springer US, Boston, MA, 2012, pp. 710–713. doi:10.1007/978-1-4419-1428-6_500.

- [2] G. C. Lee, P.-L. Lee, Data structures in flipped classroom: Students' effort and preference, in: 2015 International Conference on Learning and Teaching in Computing and Engineering, 2015, pp. 152–155. doi:10.1109/LaTiCE.2015.28.
- [3] A. Knutas, A. Herala, E. Vanhala, J. Ikonen, The flipped classroom method: Lessons learned from flipping two programming courses, in: Proceedings of the 17th International Conference on Computer Systems and Technologies 2016, CompSysTech '16, Association for Computing Machinery, New York, NY, USA, 2016, p. 423–430. doi:10.1145/2983468.2983524.
- [4] E. W. M. Ling, C. Y. Y. Li, A. R. M. Deni, Promoting student engagement using flipped classroom in large introductory financial accounting class, in: Proceedings of the 2019 3rd International Conference on Education and E-Learning, ICEEL 2019, Association for Computing Machinery, New York, NY, USA, 2019, p. 61–66. doi:10.1145/3371647.3371658.
- [5] P. Vlachopoulos, S. K. Jan, R. Buckton, A case for team-based learning as an effective collaborative learning methodology in higher education, *College Teaching* 69 (2020) 69–77. doi:10.1080/87567555.2020.1816889.
- [6] N. C. Burbules, G. Fan, P. Repp, Five trends of education and technology in a sustainable future, *Geography and Sustainability* 1 (2020) 93–97. doi:10.1016/j.geosus.2020.05.001.
- [7] C. Chang, Y. Yang, Y. Tsai, Exploring the engagement effects of visual programming language for data structure courses, *Education for Information* 33 (2017) 187–200. doi:10.3233/EFI-170108.
- [8] V. Karavirta, A. Korhonen, L. Malmi, T. Naps, A comprehensive taxonomy of algorithm animation languages, *Journal of Visual Languages & Computing* 21 (2010) 1–22. doi:10.1016/j.jvlc.2009.09.001.
- [9] E. Budiman, N. Pusnitasari, M. Wati, Haeruddin, J. A. Widians, A. Tejawati, Mobile learning media for computer science course, in: 2018 International Electronics Symposium on Knowledge Creation and Intelligent Computing (IES-KCIC), 2018, pp. 262–267. doi:10.1109/KCIC.2018.8628559.
- [10] E. Budiman, Haeruddin, U. Hairah, F. Alameka, Mobile learning: Visualizing contents media of data structures course in mobile networks, *Journal of Telecommunication, Electronic and Computer Engineering* 10 (2018) 81–86.
- [11] J. Stasko, Data structure visualization, in: D. P. Mehta, S. Sahni (Eds.), *Handbook of Data Structures and Applications*, 2nd ed., Chapman and Hall/CRC, Boca Raton, 2018, pp. 697–705. doi:10.1201/9781315119335.
- [12] A. Ševčíková, E. Milková, Multimedia applications: Graph algorithms visualization, in: 2016 IEEE 17th International Symposium on Computational Intelligence and Informatics (CINTI), 2016, pp. 000231–000236. doi:10.1109/CINTI.2016.7846409.
- [13] F. Wang, The design of public computer lab management system based on network environment, in: Proceedings of the 2016 International Conference on Education, Management and Computer Science, Atlantis Press, 2016/05, pp. 263–267. doi:10.2991/icemc-16.2016.55.
- [14] B. Tyler, M. Abdrakhmanova, Flipping the CS1 and CS2 classrooms in Central Asia, in: 2016 IEEE Frontiers in Education Conference (FIE), IEEE, 2016, pp. 1–5. doi:10.1109/FIE.

2016.7757739.

- [15] M. K. P. Peethambaran, V. G. Renumol, S. Murthy, Flipped Classroom Strategy to Help Underachievers in Java Programming, in: 2018 International Conference on Learning and Teaching in Computing and Engineering (LaTICE), IEEE, 2018, pp. 44–49.
- [16] M. Bikanga Ada, Teaching algorithms and data structures: A tale of two approaches, 2020. URL: <https://eprints.gla.ac.uk/237310/>. doi:10.25416/NTR.13302383.v1.
- [17] M. M. Hossain, Application of Flipped Learning Approach in Computing Education, Master's thesis, Itä-Suomen yliopisto, 2020. URL: https://erepo.uef.fi/bitstream/handle/123456789/23068/urn_nbn_fi_uef-20200916.pdf.
- [18] H. Hendrik, A. Hamzah, Flipped classroom in programming course: A systematic literature review, *International Journal of Emerging Technologies in Learning* 16 (2021) 220–236. URL: <https://online-journals.org/index.php/i-jet/article/view/15229>.
- [19] S. Mutua, F. Wabwoba, P. Ogao, P. Anselmo, E. Abenga, Classifying program visualization tools to facilitate informed choices: teaching and learning computer programming, *International Journal of Computer Science and Telecommunications* 3 (2012) 42–48. URL: http://www.ijcst.org/Volume3/Issue2/p8_3_2.pdf.
- [20] S. Šimoňák, Algorithm visualization using the vizalgo platform, *Acta Electrotechnica et Informatica* 13 (2013) 54. URL: <https://www.deepdyve.com/lp/de-gruyter/algorithm-visualization-using-the-vizalgo-platform-zoCNHQpqtX>.
- [21] S. Šimoňák, Algorithm visualizations as a way of increasing the quality in computer science education, in: 2016 IEEE 14th international symposium on applied machine intelligence and informatics (SAMI), IEEE, 2016, pp. 153–157.
- [22] S. Šimoňák, Using algorithm visualizations in computer science education, *Central European Journal of Computer Science* 4 (2014) 183–190. doi:10.2478/s13537-014-0215-4.
- [23] S. Šimoňák, Increasing the engagement level in algorithms and data structures course by driving algorithm visualizations, *Informatica* 44 (2020). URL: <http://www.informatica.si/index.php/informatica/article/view/2864>.
- [24] S. Šimoňák, M. Benej, Visualizing algorithms and data structures using the algomaster platform, *Journal of Information, Control and Management Systems* 12 (2014) 189–201. URL: <https://citeseerx.ist.psu.edu/viewdoc/download?doi=10.1.1.1005.9137&rep=rep1&type=pdf>.
- [25] A. A. Supli, N. Shiratuddin, S. B. Zaibon, Critical analysis on algorithm visualization study, *International Journal of Computer Applications* 150 (2016). doi:10.5120/ijca2016911633.
- [26] K. Mocinecová, W. Steingartner, Software Support for Visualizing of the Graph Algorithms in a Novel Approach in Educating of Young IT Experts, *IPSI Transactions on Internet Research* 16 (2020) 14–23. URL: <http://ipsitransactions.org/journals/papers/tir/2020jul/p3.pdf>.
- [27] T. H. Cormen, C. E. Leiserson, R. L. Rivest, C. Stein, Introduction to algorithms, third ed., The MIT Press, 2009. URL: https://edutechlearners.com/download/Introduction_to_algorithms-3rd%20Edition.pdf.

Using augmented reality for early literacy

Olena Ie. Piatykop¹, Olha I. Pronina¹, Iryna B. Tymofieieva² and Ihor D. Palii¹

¹Pryazovskyi State Technical University, 7 Universytetska Str., Mariupol, 87500, Ukraine

²Mariupol State University, 129A Budivelnkyiv Ave., Mariupol, 87500, Ukraine

Abstract

Currently, augmented reality is one of the most actively developing technologies, which has also found its application in the field of education. Analysis of various publications has confirmed that AR technology opens up new opportunities for teachers and increases the attractiveness of learning for students of different ages. Mobile AR apps allow the student to see a real-world environment with overlaid or composite virtual objects. This is especially true for young children. The article identifies the activities that provide a child's personal experience using AR technology. Comparison of existing AR applications for learning the alphabet is given. A new AR application is described, which was developed using Unity, C#, Vuforia. The developed mobile AR application provides an opportunity to study the Ukrainian alphabet, the names of numbers, the sounds of animals. Thanks to this application, the learning process is accompanied by three-dimensional visualization and sounding of each letter and number. An analysis of a survey of teachers and parents showed that when using an AR application, the interest and self-efficacy of children in learning letters and numbers significantly increased. The use of the AR application increased the speed of memorizing the material and helped to retain the child's attention while learning a new material.

Keywords

augmented reality (AR), mobile application, early literacy, visualization of educational information, AR-application, studying letters, 3D model, Vuforia

1. Introduction

In the modern world, technology development trends dictate the constant introduction of new products in all spheres of life. The technology that is currently being actively developed and implemented is augmented reality (AR). Its main advantage is that a smartphone is enough to use it. With the help of AR technology, virtual objects can be integrated into the material world: an augmented reality camera using AR programs captures reality and looks for predetermined target points in it – markers to which virtual objects are attached. Augmented reality technology

CoSinE 2021: 9th Illia O. Tepytskyi Workshop on Computer Simulation in Education, co-located with the 17th International Conference on ICT in Education, Research, and Industrial Applications: Integration, Harmonization, and Knowledge Transfer (ICTERI 2021), October 1, 2021, Kherson, Ukraine

✉ pyatikoplena@gmail.com (O. Ie. Piatykop); pronina.lelka@gmail.com (O. I. Pronina);

irtimofeeva0410@gmail.com (I. B. Tymofieieva); thekiross@gmail.com (I. D. Palii)

🌐 <https://kn.pstu.edu/kafedra-kompyuternih-nauk/kolektiv/pyatikop-olena-%D1%94vgenivna/> (O. Ie. Piatykop);

<https://kn.pstu.edu/kafedra-kompyuternih-nauk/kolektiv/pronina-olbga-igorivna/> (O. I. Pronina);

<https://scholar.google.com.ua/citations?user=8wr8cNkAAAAJ> (I. B. Tymofieieva)

🆔 0000-0002-7731-3051 (O. Ie. Piatykop); 0000-0001-7085-8027 (O. I. Pronina); 0000-0002-5935-9291

(I. B. Tymofieieva); 0000-0002-0940-5181 (I. D. Palii)

© 2022 Copyright for this paper by its authors.
Use permitted under Creative Commons License Attribution 4.0 International (CC BY 4.0).



CEUR Workshop Proceedings (CEUR-WS.org)

allows you to combine the real and virtual world. Supplement existing objects with virtual ones for better visualization. AR apps work with 3D objects, texts, images, videos, and animations. They allow you to combine and enable users to freely interact with events, information and objects [1, 2, 3, 4, 5].

With the development of software and hardware, augmented reality technologies are actively used in many areas: advertising, entertainment (games), marketing, medicine, engineering, and much more. As one know, the best technologies are being introduced into educational processes, as the fundamental facet of the entire development of society [2].

Literacy is a critical aspect of the healthy growth and development of young children. Early childhood education is the period when a child develops skills, knowledge and interest in learning. Including the basics of written and spoken language. Since the problem of reading among elementary school children is especially acute today. According to the standards, by the end of the first grade, the child should read aloud the available texts mainly in whole words (individual words of a complicated structure – in compositions). Which involves knowingly reading 40 words per minute [6]. Consequently, in the case of late literacy, the child during the period of study in the first grade, in addition to the stress due to the mode of life, receives the stress of academic failure. To avoid problems in the process of school education, it is necessary to start learning literacy in a playful way at an early preschool age.

Today, AR's potential for education is being actively explored by Osipova et al. [1], da Silva et al. [2], Santos et al. [3], Syrovatskyi et al. [4], Wojciechowski and Cellary [5], Kiv et al. [7], Thomas et al. [8], Singhal et al. [9]. In the race to improve the memorization of the material by students, teachers are trying to diversify the educational process. That is why the introduction of the ability to interact simultaneously with virtual and real objects will make the learning process more fun and memorable [9]. In addition, the introduction of augmented reality technology into the educational process can increase the creative component of a student's thinking. And it will also help to perceive complex things in a visual way "from all sides", which will make learning more flexible and deep. Therefore, the use of AR in education is an important task. The use of augmented reality technology is a very promising direction for the education system [2, 7, 8]. This requires the appropriate software. Not every teacher can prepare a mobile program [1, 4]. Therefore, the development of the necessary mobile applications is very important [4].

2. Literature review

Each stage of education has its own key characteristics. Augmented reality in higher education is focused on the study of material, which previously could only be studied theoretically on the image in the book. For example, Thomas et al. [8] describe current examples of the use of augmented reality that can improve teaching and learning in various areas of higher education, including, but not limited to, medical education, language learning and science. And also offer possible ways of implementation in the educational process. Nesenbergs et al. [10] offer generalized knowledge of how augmented reality technologies are applicable and affect distance learning in higher education. Namely, identifying the impact on such learning outcomes as academic performance and engagement at all stages of higher education from preparation for

the course to assessment and grading of students.

Actual use of augmented and virtual reality to study dangerous to human areas, mechanisms and instruments. In this case, the use of AR will allow you to consider the process in detail, try to independently perform a number of actions, which increases the level of knowledge and reduces the percentage of risks. The experience of using these modern technologies has already been described in a number of publications. Saravas et al. [11] describes a VR simulator for training workers of metallurgical enterprises in the design of complex mechanisms before starting repair work. At the heart of the simulator, the authors propose a component that can be used for any virtual reality equipment and will be further adapted to augmented reality devices. The use of virtual reality is presented by Song et al. [12] as a set of virtual reality training systems for three different types of cranes for students. The results of a study at the Department of Architecture and Architectural Engineering, Yonsei University, South Korea showed that the VR crane training system significantly improved students' self-esteem when operating the crane. The analysis showed that the change in self-efficacy is due to ease of use, mediated by the sense of presence and perceived usefulness.

Implementation of AR programs was carried out in many subjects. The work of Tosik Gün and Atasoy [13] is devoted to the analysis of learning outcomes in mathematics. The students studied "Geometric objects and measuring volume". Instead of the classical material, didactic materials with AR markers on paper were provided. The results of the study confirm an increase in the comprehensibility of the chosen topic and an increase in academic performance. Also in work by Hung et al. [14] the application of AR in biology lessons is considered, namely the comparison of understanding the material using augmented reality and with the standard use of textbooks. The results showed that the lessons with augmented reality were deeper in the study of the material and more practice-oriented. Which, in turn, is more interesting for children.

Augmented reality in secondary education is focused on supplementing existing knowledge with more visual demonstrations, as well as explaining abstract phenomena with examples that can be detailed. In [15], augmented reality technology was used in physics lessons within the school curriculum, which showed a deeper academic performance, as well as involvement in the academic subject. Salmi et al. [16] came to the conclusion that the use of AR in the learning process is effective for all children, especially for those who previously had low academic performance and learning ability.

Augmented reality in education involves expanding existing knowledge or learning new ones with the help of visual aids, which improves the quality of the study of the material. Today there is experience of using augmented reality for school textbooks, teaching aids, books [17, 18, 19, 20].

Kravtsov and Pulinets [17] describes the use of AR on the example of visualization of models of physical processes in a school physics course. The authors have developed 3D models that appear when hovering over pictures in physics textbooks. Also, visualization of the thermal conductivity of physical bodies using AR allows the student to participate in the experiment.

A particular attraction is the use of augmented reality in the education of young children [21, 22, 23, 24, 25, 26, 27, 28]. Yilmaz et al. [18] examined the understanding of information by preschoolers, as well as whether they enjoy the process. The research results demonstrate the emotional involvement of children in the learning process and their emotional uplift. The use of AR software for studying books made it possible to notice that children remember the

plot faster, and then they involve their parents in retelling the story based on “coming to life pictures” [18, 19].

Play as a teaching and learning tool for preschool children is suggested by Chrisna et al. [23]. The aim of the research is to create an educational game about animals for young children. The authors propose an augmented reality app “Kotak Edu” that teaches children to identify three-dimensional animal shapes and helps improve literacy.

Costa et al. [24] also focuses on game-based learning. The paper presents a mobile augmented reality platform for educational purposes. The platform includes a mobile application, which consists of a location game aimed at understanding the universe, and an e-office, which allows teachers to enter information about celestial bodies.

An urgent task for the application of augmented reality is an early literacy [22, 23, 25, 26, 27, 28]. Mahayuddin and Mamat [25] studied the use of a mobile augmented reality application for teaching phonetic literacy to children with autism. At the Malak Autism Education Center, educators used the AR-app to improve literacy in children with autism using a phonetic teaching method. Observations have shown that children with autism are addicted to three-dimensional visual objects, and the application helps to associate graphics with images of the surrounding objects. Visual and sound effects attract children and focus their attention mainly on literacy and learning. But the authors consider the unstable operation of the mobile AR-application to be a negative point, which requires further refinement.

Che Dalim et al. [26] explores how AR technology helps young children learn English that is not their native language. The article describes the experience of children in terms of gaining knowledge and pleasure from learning using a combination of AR and speech recognition technologies. For this, the authors have developed a prototype AR “TeachAR” interface. Experiments have shown that thanks to the combination of AR and the traditional method, young children learn language faster and easier.

The experience of developing and using a mobile application with augmented reality for learning the alphabet by children is described by Nanda and Jha [27]. The authors confirm that the possibilities of augmented reality are a fun new way to involve children in learning the alphabet. The AR-app allows kids to become more familiar with letter recognition, learn letter pronunciation and improve their skills and memorization.

Nigam et al. [28] also presents an augmented reality application that creates an interactive alphabet learning environment for children. The authors report that the app motivates children to self-study.

Thus, augmented reality is widely used at various levels of education such as higher education, secondary education, primary education, and preschool education.

For young children, training is successfully carried out with a playful form. Motivation, fun, and curiosity are important ingredients in any educational game. Publications confirm that this can be achieved using augmented reality technologies.

Augmented reality in preschool education involves the use of colorful images of simple things such as illustrations for a book, simple shapes, animals, numbers, and the beginning of learning the alphabet.

From the age of 3, the child remembers the order of actions with the phone starting from the fourth demonstration. Thus, even without knowing how to read, the child can use the mobile application on his own. The mobile application is seen as an additional element of interest in

training and will not replace a fully-fledged training.

However, implementation in early childhood education is still limited as the required software is required. Therefore, the development of a learning environment with augmented reality for learning Ukrainian letters for young children is very important.

3. Activities that provide a personal experience of the child with the help of AR technology

The characteristic of competence as a personal achievement of a child, as a result of the educational activity of an adult with a child, is considered by us as a sequence: an emotional-value attitude, the formation of knowledge, life skills [29]:

- *Emotional-value attitude*: shows interest in computer and digital technology (computer, tablet, phone); motivated by the value of respectable interaction in the Internet space; has a cognitive need for discussion during computer games (educational, developmental, game), shows respect for other participants in the information space (users), shows a positive attitude towards modern digital technologies, reacts emotionally to the plot of computer games, demonstrates interest in communicating with others through technical means during the game and outside it, determines the value preference in the choice of educational and developmental games, and the like.
- *Formation of knowledge*: has an idea of information, communication and digital technologies as modern technical means that expand information horizons and help to navigate in the world in conditions of high technicalization of life, demonstrates the formation of knowledge about the features of computer technology, ways to control it with the help of peripheral devices, correctly names its components, knows the purpose and names of peripheral devices, deliberately uses computer technology (as intended); possesses the skills of searching, transferring information, is familiar with the basic resources of the Internet and the rules of the information world and knows how, if necessary, to protect himself from various information threats, practically possesses digital tools, knows how to use interactive exercises, performs operations and algorithmic actions of the initial user, which constitute one of the essential components of educational activities, realizes digital technologies contribute to the development of skills necessary for problem solving, analytical thinking, creativity, the formation of interpersonal emotional intelligence, including empathy, cooperation, social awareness).
- *Life skills*: a child is able, independently or with partial help from an adult, to turn on computer equipment and use it while playing, drawing, constructing, modeling. Complies with the safety rules for the use of computer technology. Manages himself while communicating on the Internet and in computer games, discovers the ability to behave safely with strangers on the network; is responsible for respecting computer technology; can deliberately differentiate and select cognitive and game content, characterizes its content; shows the ability to complete computer lessons on time.

The work consists of three stages:

- first is the presentation of the original problem due to the situation – the identification of a friend in a new material;
- second is the presentation of a visual image – forecasting, putting forward hypotheses about the past or future of objects, a situation that needs to be understood;
- third is the implementation of practical actions with cognitive material – the unification of the elements of the understandable as a whole.

The listed activities of a child with AR technologies and stages of work are possible if there are structural components of the learning model. We have defined the construction of a teaching model as an imitation of the educational process of teaching literacy by creating a schematic order. The training model has the following form (figure 1), it reflects all the elements as a single system.

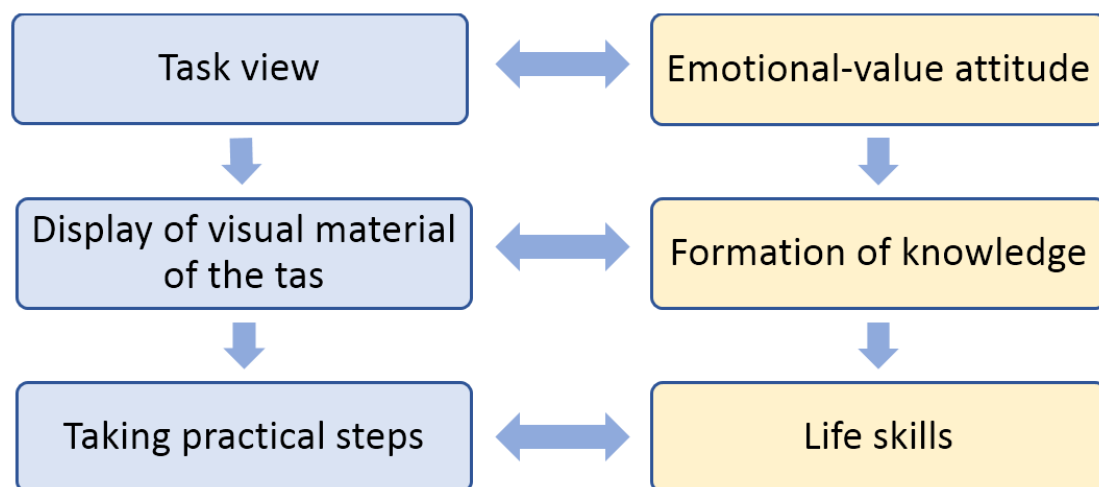

Figure 1: Stages of work with AR technology.

At the center of all work is the child of preschool age as the central object of the influence of many factors: content, pedagogical, didactic, technological and others. When organizing cognitive activity, the following algorithm is advisable: all codes are used that carry a sensory-cognitive, logical-mathematical meaning, elements of research search – a word, a drawing, a physical image, a diagram, a model, and practical actions [29].

The introduction of early literacy is an excellent simulator for the classic literacy that a child will encounter in the senior group of kindergarten and in elementary school. In addition, at an early stage of literacy, the child's interest in learning can be adjusted, the intensity of learning can be smoothly introduced, thereby learning will take place in a healthy and environmentally friendly manner.

In this regard, a more detailed study of this problem made it possible to identify the necessary rules for using AR. We make the following proposals for the promising spread of directions for using AR technologies for teaching preschool children and primary school children:

- Continuous viewing of training exercises – no more than 15 minutes.

- Working with modern technologies in accordance with sanitary requirements is allowed no more than 2 times a week (morning and afternoon).
- Based on the content of teaching literacy under the “Confident Start” program [29] in preschool educational institutions, the mobile AR-application will allow you to adjust the educational process, prepare the child for school: during the pre-literate period, master the elements of literacy, carry out preparatory, propaedeutic work to master the elements of written speech; to get acquainted with the basic units of speech and learn how to correctly use the terms to mean “sentences”, “words”, “sound”, “syllables”, “letters”.

4. Analysis of similar mobile applications

During the research of analogs existing in the Google Play Store, many applications similar in topic and technical direction were identified. But only those that use augmented reality technology were selected. At the same time, they are aimed at carrying the elements of the game into the process of teaching children language basics.

Alphabet-AR [30] is an addition to the printed alphabet, aimed at capturing children’s attention to the process of learning the Ukrainian language. By scanning the pages of the book, the application installs in their place a three-dimensional animated model, endowed with sound in the form of individual sounds, words or verses. The 3D models used in *Alphabet-AR* are endowed with bright colors and pleasing visual style, which is a definite advantage considering the target audience.

Unfortunately, it was not possible to conduct a full testing of the product, as it is necessary to purchase a special alphabet, a link to which was not found during the inspection of *Alphabet-AR*. This fact can be attributed to a number of disadvantages, since everyone will not be able to freely use this application.

Another analogue, similar to the program under development, is the *360ed Alphabet AR* [31], aimed at teaching children the English language using augmented reality and linguistic games. Unlike the previous program, in this product there is a link to a demo card with vivid images necessary for displaying models in augmented reality, as well as the ability to listen to the names of cards in different languages. From a technical and graphical point of view, the app is executed on high pebbles. The only drawbacks are the inability to choose the Ukrainian interface language and the need to purchase the full version of the program to open the full range of application capabilities.

The latest analogue of *Kids Alphabet Learning with Augmented Reality* [32] differs from the previous counterparts in its minimalistic interface design and limited functionality. The program has the ability to scan maps, which can be downloaded through the built-in instructions, and display flat drawings based on the scanned image. This is the main and only function available in the application, which is a disadvantage. But it should be noted that the visual style used looks attractive to the target audience.

So, the considered analogs of applications indicate that on the market of free mobile applications there are many similar programs that differ only in the quality of execution, language and territorial characteristics. On the other hand, it should be noted that there are almost no separate applications aimed at the Ukrainian-speaking user. In addition, a combination of skills

Table 1
Comparison of the analyzed analogs

Comparison indicator	Application		
	Alphabet-AR	360ed Alphabet AR	Kids Alphabet Learning with AR
Using 3D models	+	+	-
Using AR (augmented reality)	+	+	+
Availability of sound	+	+	-
The presence of the Ukrainian language	+	-	-

in learning letters, numbers and animal sounds was not found.

Also, applications, functional and technical elements, which can become a support for further development, are analyzed (table 1).

Thus, both the advantages of existing analogues and disadvantages were taken into account. Based on this knowledge, it was decided to develop a new application “Fox Alphabet AR”, which maximizes all the advantages and takes into account the disadvantages of analogs.

5. Development of a mobile application “Fox Alphabet AR”

For the development of the application, a free cross-platform environment for developing computer games Unity was chosen. This environment has a rich set of tools for creating 3D measurements in augmented reality. To write program modules, the object-oriented programming language C# was used, since there is support for the latest version of Unity [33]. During the development of the application, an analysis of existing libraries and add-ons was carried out that allow displaying three-dimensional objects in augmented reality. It was necessary to give preference to one of the alternatives: ARCore [34] or Vuforia [35]. We compared the performance of a mobile app with augmented reality based on general performance characteristics based on Vuforia and AR Core (table 2). From the above table, you can see that software applications behave in about the same way, but the launch speed of an application built on ARCore is higher. If we analyze the accuracy of working with the application, and this is the main criterion, since the application is planned for children to work, then Vuforia works better at short distances, and ARCore at further ones. In addition, Vuforia is more efficient than ARCore.

From the above table, you can see that software applications behave in about the same way, but the launch speed of an application built on ARCore is higher. If we analyze the accuracy of working with the application, and this is the main criterion, since the application is planned for children to work, then Vuforia works better at short distances, and ARCore at further ones. In addition, Vuforia is more efficient than ARCore.

Thus, in order to ensure the minimum requirements for the hardware component of the future product, it was decided to choose the second possible version of the library. Although the technical potential of the Vuforia package lags slightly behind ARCore, the available functionality will be enough to complete the task. The main function of the application is to study the Ukrainian alphabet. For this, models of letters were created, which are shown in the figure 2. Additionally,

Table 2

Testing applications running on Vuforia and ARCore

No	Comparison indicator	Vuforia	ARCore
1	Change screen orientation: vertical positioning	+	+
2	Change the screen orientation: horizontal positioning	+	+
3	Interrupt: call	+	+
4	Interrupt: sms	+	-
5	Interrupt: system notification	+	+
6	Interrupt: folding	-	+
7	Interrupt: sleep mode	+	-
8	Device memory full	-	+
9	Insufficient battery charge (less than 20%).	+	+
10	Display accuracy at a phone angle of 20 to 160 degrees	71%	67%
11	The efficiency of the application when changing the distance of the smartphone to the marker from 10 to 65 centimeters	74%	61%
12	Application launch speed	7 sec	4 sec

the application contains models of numbers and animals. For all letters, corresponding sounds are provided, for numbers – the sound of the name, for animals – their sounds.

To save images, with subsequent recognition by the system, a database was chosen offered by the Vuforia platform, which is available to registered users [35]. Also, in order to provide users with the ability to freely download and use the cards necessary for recognition by the application, it was decided to embed a link to the archive in the Google Drive cloud storage.

Before writing software modules and setting up augmented reality, the first priority is to load images into the Vuforia database that will be used for scanning. For this, two groups of cards (letters and numbers) were selected, which will become the basis for displaying 3D models in subsequent development steps. A total of 47 images were used, sized 3.15 MB. Along with the image, a list of audio signals of the same number is created.

The next step in creating augmented reality is to assign to each image, from a previously created database, the corresponding 3D models. Thus, for each card after successful recognition, its own three-dimensional model will appear. Recognition is implemented by means of the Vuforia library.

The assignment of the image to the corresponding 3D models is done by hand using the Unity editor. For this, a software module is implemented for each image, in which the application receives instructions for actions when the image is recognized by the camera. An example of the object from the development environment is shown in the figure 3.

To increase the speed of the system, it was decided to split the application into two modules. The first module includes only the interface, and the second – the main functionality of augmented reality.

To work with the application, the main menu is provided, where you can select one of the training sets. Also added instructions and additional notification of the need to download the cards on which the training takes place. All actions for the child are also voiced in the application. In addition, when you point the phone at the card and when the 3D model appears,

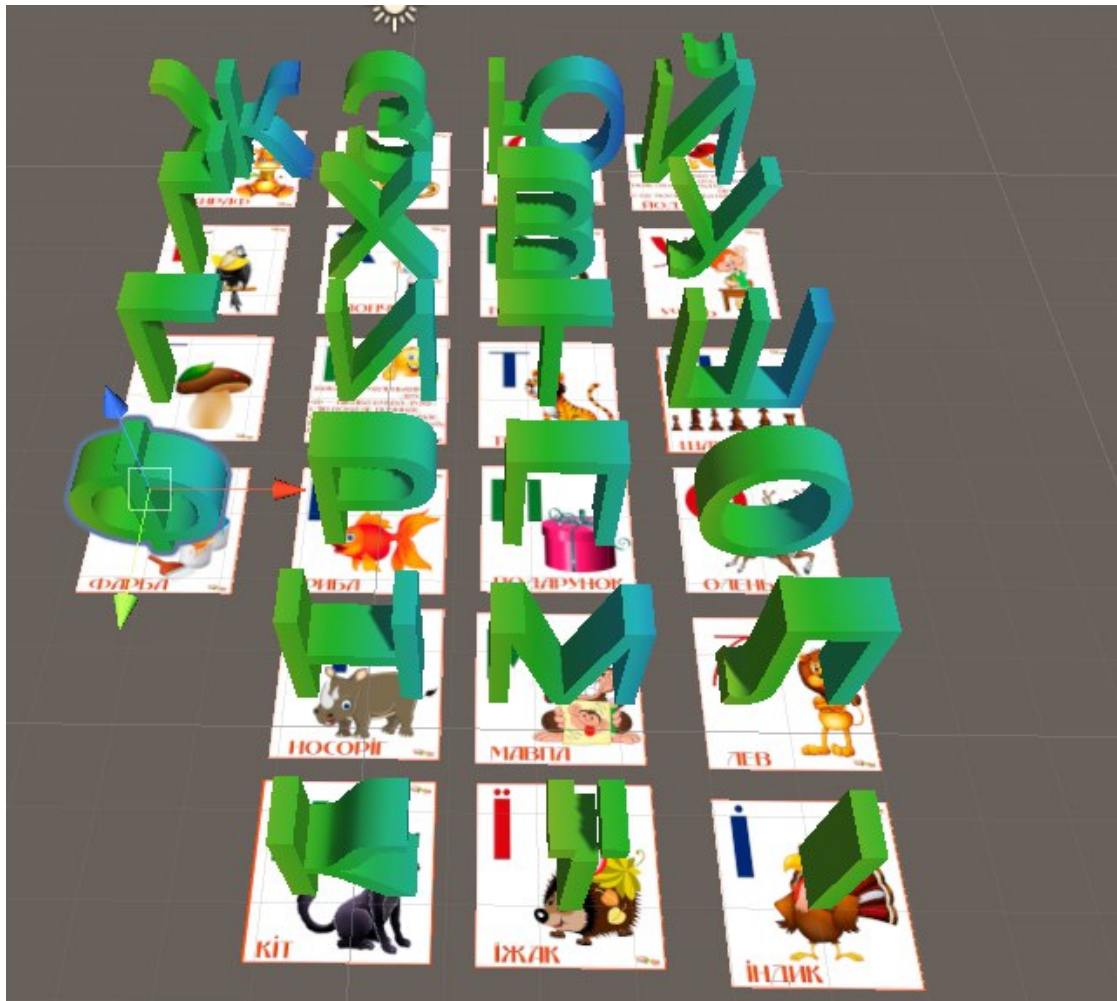

Figure 2: Examples of 3D letter models.

dubbing occurs. Thus, learning takes place on a visual level and on an auditory and tactile level. Since the cards can be printed separately, and the child can play with them outside of training in the application. In order to study the next map, it is enough to point the phone at it. The figure 4 shows an example of how the application works.

6. Results and discussion

The study of letters – the alphabetical period in the modern method of teaching literacy is divided into two stages. At the first stage, the letters denoting vowel sounds are studied and letters denoting consonants. At the second stage – letters that contain several sounds, as well as letters that make the sound softer, in which children move on to reading words of a more complex structure. The division into stages is advisable because it allows you to more clearly

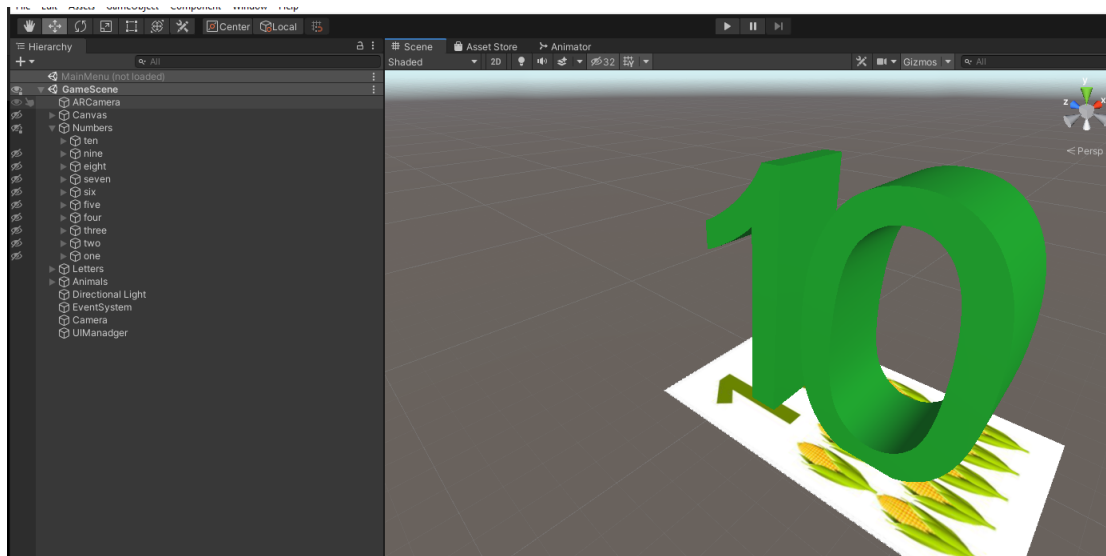

Figure 3: The example screen view of the object from the development environment.

define the tasks of the stages of learning and thus develop a system and methodology for the work of teachers and children.

In the experiment, we took into account the new requirements for training in accordance with the Concept of the New Ukrainian School, the main goal of which is to prepare a competent modern Ukrainian. Therefore, it is necessary to change the forms, methods and technologies of teaching. An experiment was conducted on the use of the developed mobile application with augmented reality among children.

We carried out a survey of the participants in the experiment, namely, teachers of educational institutions and parents of the city of Mariupol.

The survey was designed to analyze and support further data collection on the current trend in AR learning adoption. The objective of the survey was to collect enough examples of software applications to determine whether the mobile application was useful.

As the parameters of the survey, we chose the achievement of a certain function and the use of certain capabilities by students. For our study, it was important to identify the interrelated characteristics of learning (the speed of learning – familiarization, the speed of memorization and the frequency of independent use of letters), which affect the learning outcomes. Evaluation of success in terms of indicators was determined by two groups of survey participants: teachers and parents. An analysis of the implementation of an AR application for educational institutions and parents is shown in the table 3.

The table displays the number of days for a child to achieve a certain function before and after using the AR mobile application. The figure 5 shows a diagram of the views of teachers, and the figure 6 – the opinions of parents.

To analyze the use of the developed software according to the first characteristic, it was found that the speed of a child's acquaintance with letters increased, the study became 2.5 times faster than without the use of AR technologies.



Figure 4: An example of using the application “Fox Alphabet AR”.

According to the second characteristic, the speed of memorization increased according to the observations of parents and teachers from 10 days to 3 days and from 5 days to 3 days, respectively. This demonstrates the effectiveness of the use of AR technologies at different stages of the study of letters. The data of the third characteristic – the frequency of independent use, most clearly demonstrate a well-designed application. This confirms the fact that children tend to independently use the learned letters when performing tasks and in everyday life (respectively, they use the studied material 2 times more often than without the use of AR technologies). Average registered effect size – doubled letter and learning frequency.

Thus, the results showed that the learning system for letters and numbers when using AR significantly increased the interest and self-efficacy of children. The speed of memorizing the material has also increased.

Table 3

Results of the answers of teachers to the question: Do you find this technology affects children's learning?

	opinions of educators (27)			opinions of parents (81)		
	Speed of study by the child (days)	Speed of memorization by the child (days)	Frequency of self-use (days)	Speed of study by the child (days)	Speed of memorization by the child (days)	Frequency of self-use (days)
Before the introduction of AR	5	10	3	10	5	5
After the introduction of AR	2	3	6	2	3	10

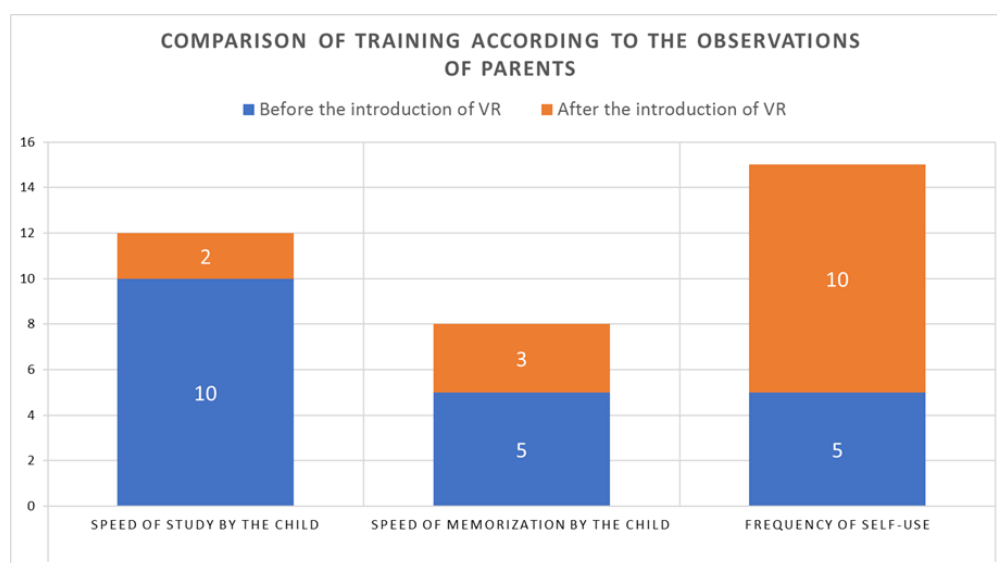

Figure 5: The results of parents' opinions.

7. Conclusions

Currently, augmented reality is one of the most actively developing technologies, which has also found its application in the field of education. AR technology opens up new opportunities for teachers and increases the attractiveness of learning for students of different ages. This is especially true for young children, since 3D models have good visibility and high attractiveness.

The mobile AR application developed by us "Fox Alphabet AR" provides an opportunity to study the Ukrainian alphabet, the names of numbers, the sounds of animals. Thanks to this application, the learning process is accompanied by 3D visualization and sounding of each letter and number.

Children who do not receive early literacy continue to decode new information with less quality in elementary school, which slows down the learning process and contributes to psy-

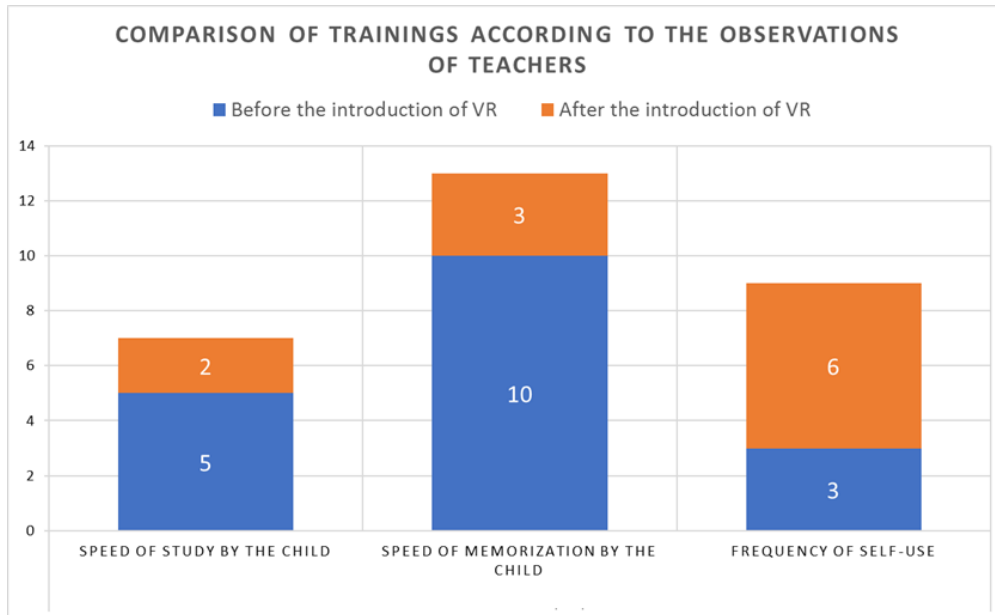

Figure 6: The results of teachers' opinions.

chological difficulties during the period of adaptation to school. This can cause the child to lag behind in the learning process. The study of initial competencies, such as knowledge of the alphabet, allows you to increase the level of decoding of teaching information received from the teacher.

An analysis of a survey of teachers and parents showed that when using an AR application, the interest and self-efficacy of children in learning letters and numbers significantly increased. The use of the AR application increased the speed of memorizing the material and helped to retain the child's attention while learning a new material.

In the future, we plan to add visualization of the study of syllables, shapes, colors to support the early development of children.

References

- [1] N. Osipova, H. Kravtsov, O. Gnedkova, T. Lishchuk, K. Davidenko, Technologies of virtual and augmented reality for high education and secondary school, CEUR Workshop Proceedings 2393 (2019) 121–131.
- [2] M. M. O. da Silva, J. M. X. N. Teixeira, P. S. Cavalcante, V. Teichrieb, Perspectives on how to evaluate augmented reality technology tools for education: a systematic review, Journal of the Brazilian Computer Society 25 (2019) 3. doi:10.1186/s13173-019-0084-8.
- [3] M. E. C. Santos, A. Chen, T. Taketomi, G. Yamamoto, J. Miyazaki, H. Kato, Augmented reality learning experiences: Survey of prototype design and evaluation, IEEE Transactions on Learning Technologies 7 (2014) 38–56. doi:10.1109/TLT.2013.37.
- [4] O. V. Syrovatskyi, S. O. Semerikov, Y. O. Modlo, Y. V. Yechkalo, S. O. Zelinska, Augmented

- reality software design for educational purposes, *CEUR Workshop Proceedings* 2292 (2018) 193–225. URL: <http://ceur-ws.org/Vol-2292/paper20.pdf>.
- [5] R. Wojciechowski, W. Cellary, Evaluation of learners' attitude toward learning in ARIES augmented reality environments, *Computers & Education* 68 (2013) 570–585. doi:10.1016/j.compedu.2013.02.014.
- [6] On the approval of standard educational programs for grades 1-2 of general secondary education institutions, 2019. URL: <https://mon.gov.ua/storage/app/uploads/public/5d9/d8f/eb1/5d9d8feb1ce4f316467013.pdf>.
- [7] A. E. Kiv, M. P. Shyshkina, S. O. Semerikov, A. M. Striuk, Y. V. Yechkalo, AREdu 2019 – How augmented reality transforms to augmented learning, *CEUR Workshop Proceedings* 2547 (2020) 1–12.
- [8] R. Thomas, K. E. Linder, N. Harper, W. Blyth, V. Yee, Current and Future Uses of Augmented Reality in Higher Education, Technical Report 81, IDEA, 2019. URL: https://www.ideaedu.org/idea_papers/current-and-future-uses-of-augmented-reality-in-higher-education/.
- [9] S. Singhal, S. Bagga, P. Goyal, V. Saxena, Augmented chemistry: Interactive education system, *International Journal of Computer Applications* 49 (2012). doi:10.5120/7700-1041.
- [10] K. Nesenbergs, V. Abolins, J. Ormanis, A. Mednis, Use of augmented and virtual reality in remote higher education: A systematic umbrella review, *Education Sciences* 11 (2021) 8. URL: <https://www.mdpi.com/2227-7102/11/1/8>. doi:10.3390/educsci11010008.
- [11] V. Saravas, E. Pahalchuk, A. Molchan, Y. Kampov, The development of educational application with virtual reality placing objects system using snap zone technology, in: 2020 IEEE 11th International Conference on Dependable Systems, Services and Technologies (DESSERT), 2020, pp. 416–421. doi:10.1109/DESSERT50317.2020.9125023.
- [12] H. Song, T. Kim, J. Kim, D. Ahn, Y. Kang, Effectiveness of VR crane training with head-mounted display: Double mediation of presence and perceived usefulness, *Automation in Construction* 122 (2021) 103506. doi:10.1016/j.autcon.2020.103506.
- [13] E. Tosik Gün, B. Atasoy, The effects of augmented reality on elementary school students' spatial ability and academic achievement, *Education and Science* 42 (2017) 31–51. doi:10.15390/EB.2017.7140.
- [14] Y.-H. Hung, C.-H. Chen, S.-W. Huang, Applying augmented reality to enhance learning: a study of different teaching materials, *Journal of Computer Assisted Learning* 33 (2017) 252–266. doi:10.1111/jcal.12173.
- [15] S. Cai, F.-K. Chiang, Y. Sun, C. Lin, J. J. Lee, Applications of augmented reality-based natural interactive learning in magnetic field instruction, *Interactive Learning Environments* 25 (2017) 778–791. doi:10.1080/10494820.2016.1181094.
- [16] H. Salmi, H. Thuneberg, M.-P. Vainikainen, Making the invisible observable by augmented reality in informal science education context, *International Journal of Science Education, Part B* 7 (2017) 253–268. doi:10.1080/21548455.2016.1254358.
- [17] H. Kravtsov, A. Pulinets, Interactive augmented reality technologies for model visualization in the school textbook, *CEUR Workshop Proceedings* 2732 (2020) 918–933.
- [18] R. M. Yilmaz, S. Kucuk, Y. Goktas, Are augmented reality picture books magic or real for preschool children aged five to six?, *British Journal of Educational Technology* 48 (2017) 824–841. doi:10.1111/bjet.12452.
- [19] S. I. Pochtoviuk, T. A. Vakaliuk, A. V. Pikilnyak, Possibilities of application of augmented

- reality in different branches of education, CEUR Workshop Proceedings 2547 (2020) 92–106.
- [20] N. Honcharova, Technology of augmented reality in textbooks of new generation, Problems of Modern Textbook (2019) 46–56. doi:10.32405/2411-1309-2019-22-46-56.
- [21] I. Bistaman, S. Z. Syed Idrus, S. Abd Rashid, The Use of Augmented Reality Technology for Primary School Education in Perlis, Malaysia, Journal of Physics: Conference Series 1019 (2018) 012064. doi:10.1088/1742-6596/1019/1/012064.
- [22] M. Z. Masmuzidin, N. A. A. Aziz, The current trends of augmented reality in early childhood education, The International Journal of Multimedia & Its Applications 10 (2018) 47–58. URL: <https://aircconline.com/abstract/ijma/v10n6/10618ijma05.html>.
- [23] V. Chrisna, Leonardo, T. Satria, Kotak Edu: An Educational Augmented Reality Game for Early Childhood, Journal of Physics: Conference Series 1844 (2021) 012027. doi:10.1088/1742-6596/1844/1/012027.
- [24] M. C. Costa, A. Manso, J. Patrício, Design of a mobile augmented reality platform with game-based learning purposes, Information 11 (2020) 127. URL: <https://www.mdpi.com/2078-2489/11/3/127>. doi:10.3390/info11030127.
- [25] Z. R. Mahayuddin, N. Mamat, Implementing Augmented Reality (AR) on Phonics-based Literacy among Children with Autism, International Journal on Advanced Science, Engineering and Information Technology 9 (2019) 2176. doi:10.18517/ijaseit.9.6.6833.
- [26] C. S. Che Dalim, M. S. Sunar, A. Dey, M. Billinghamurst, Using augmented reality with speech input for non-native children's language learning, International Journal of Human-Computer Studies 134 (2020) 44–64. doi:10.1016/j.ijhcs.2019.10.002.
- [27] S. Nanda, S. Jha, Augmented reality – an application for kid's education, International journal of engineering research & technology 5 (2017). URL: <https://www.ijert.org/augmented-reality-an-application-for-kids-education>.
- [28] A. Nigam, K. K. Bhagat, M. Chandrakar, P. Goswami, Design and development of an augmented reality tracing application for kindergarten students, in: 2019 IEEE Tenth International Conference on Technology for Education (T4E), 2019, pp. 240–241. doi:10.1109/T4E.2019.00-14.
- [29] Basic component of preschool education (State standard of preschool education). New edition, 2021. URL: https://mon.gov.ua/storage/app/media/rizne/2021/12.01/Pro_novu_redaktsiyu%20Bazovoho%20komponenta%20doshkilnoyi%20osvity.pdf.
- [30] Alphabet-AR, 2021. URL: <https://play.google.com/store/apps/details?id=com.R0stishka.AlphabetAR>.
- [31] 360ed Alphabet AR, 2021. URL: <https://play.google.com/store/apps/details?id=com.threesixtyed.alphabetinterar>.
- [32] Kids Alphabet Learning with Augmented Reality, 2021. URL: <https://play.google.com/store/apps/details?id=com.ar.alphabets>.
- [33] Unity Real-Time Development Platform | 3D, 2D VR & AR Engine, 2021. URL: <https://unity.com>.
- [34] Build new augmented reality experiences that seamlessly blend the digital and physical worlds, 2021. URL: <https://developers.google.com/ar>.
- [35] Getting started: VuforiaLibrary, 2021. URL: <https://library.vuforia.com/getting-started/overview.html>.