

The Cyber-Physical System for Increasing the Efficiency of the Iron Ore Desliming Process

Volodymyr Morkun^a, Natalia Morkun^a, Andrii Pikilnyak^a, Serhii Semerikov^b, Oleksandra Serdiuk^a, Irina Gaponenko^a

^a Kryvyi Rih National University, Vitaly Matusevich str, 11, Kryvyi Rih, 50027, Ukraine

^b Kryvyi Rih State Pedagogical University, Gagarin av. 54, Kryvyi Rih, 50086, Ukraine

Abstract

It is proposed to carry out the spatial effect of high-energy ultrasound dynamic effects with controlled characteristics on the solid phase particles of the ore pulp in the desliming input product to increase the efficiency of thickening and desliming processes of iron ore beneficiation products. The above allows predicting the characteristics of particle gravitational sedimentation based on an assessment of the spatial dynamics of pulp solid-phase particles under the controlled action of high-energy ultrasound and fuzzy logical inference. The object of study is the assessment of the characteristics and the process of control the operations of thickening and desliming of iron ore beneficiation products in the conditions of the technological line of the ore beneficiation plant. The subject of study is a cyber-physical system based on the use of high-energy ultrasound radiation pressure effects on iron-containing beneficiation products in the technological processes of thickening and desliming. The working hypothesis of the project is that there is a relationship between the physical-mechanical and chemical-mineralogical characteristics of the iron ore pulp solid-phase particles and their behavior in technological flows under the influence of controlled ultrasonic radiation, based on which the imitation modeling of the gravitational sedimentation process of the iron ore pulp solid-phase particles can be performed directly in the technological process. Also, the optimal control actions concerning the processes of thickening and desliming can be determined.

Keywords

Cyber-physical system, simulation, ultrasound, gamma radiation, fuzzy inference, desliming

1. Introduction

An important element in the chain of the technological process of iron ore concentrate obtaining at mining and processing plants is gravity hydraulic beneficiation in deslimers. The use of deslimers, depending on the stage of beneficiation, allows increasing the mass fraction of total iron in the thickened product by 0.5-3.5%. It is possible to reduce the negative impact of variable characteristics of ore on the productivity and energy consumption of technological complexes of the processing plant only if there is operational information on the main characteristics of raw materials and processing products, which can be obtained by analyzing the behaviour of pulp solid-phase particles under the action of high-energy ultrasound. Therefore, the development of methods and tools aimed at improving the efficiency of the processes of thickening and desliming of iron ore beneficiation products based on the use of ultrasonic effects is an urgent scientific problem.

IntelITSIS'2021: 2nd International Workshop on Intelligent Information Technologies and Systems of Information Security, March 24–26, 2021, Khmelnytskyi, Ukraine

EMAIL: morkunv@gmail.com (V. Morkun); nmorkun@gmail.com (N. Morkun); pikilnyak@gmail.com (A. Pikilnyak); semerikov@gmail.com (S. Semerikov); o.serdiuk@i.ua (O. Serdiuk); gaponenko@gmail.com (I. Gaponenko)

ORCID: 0000-0003-1506-9759 (V. Morkun); 0000-0002-1261-1170 (N. Morkun); 0000-0003-0898-4756 (A. Pikilnyak); 0000-0003-0789-0272 (S. Semerikov); 0000-0001-5629-0279 (O. Serdiuk); 0000-0002-0339-4581 (I. Gaponenko)



© 2021 Copyright for this paper by its authors.
Use permitted under Creative Commons License Attribution 4.0 International (CC BY 4.0).

CEUR Workshop Proceedings (CEUR-WS.org)

2. Related Works.

In [1] the flocculation of iron ore raw materials in deslimers at an ore processing plant is investigated. The dependences of the flocculation efficiency (sedimentation rate, turbidity and sediment volume) on the flocculant dose were obtained. At the same time, the disadvantage of this approach is the use of chemical action, which complicates the operational control of the processes of thickening and desliming. In [2], the dependences of the increase in the residence time of solid-phase particles due to the depth of the sediment layer and due to the sediment flow are presented. The efficiency indicators of the thickening process are calculated. At the same time, the disadvantage is that the work does not offer methods of operational control of the characteristics of ore particles, in particular their size. The study results of the dehydration process for suspension, the solid phase of which consists mainly of ultrafine particles, are presented in [3]. In this approach, the issue of the control action formation directly in the course of the technological process to increase the efficiency of thickening processes is considered. In [4] methods of computational fluid dynamics were used to optimize the design and performance of thickening operations. The authors used the particle number balance model. The approach requires additional research to form the information support of the operational data control system for the distribution of particles in the thickener and their physical-mechanical and chemical-mineralogical characteristics. In [5] it was proved that at the concentration of the flocculant solution the concentration of sands with and without a shift differs significantly. To apply the presented dependencies when controlling the processes of thickening and desliming, it is necessary to consider the differences in the characteristics of individual mineralogical and technological varieties of ore material, as well as surface contamination of ore particles. The processes of removing highly dispersed suspended solids from process water during the iron ore beneficiation were studied in [6]. The disadvantage of this approach is the use of chemical action on the processes of thickening and desliming, which complicates the operational control of the processes. In [7], an evolutionary algorithm for the synthesis of a neural network model using data collected from an ore-processing plant was proposed. This approach requires additional research to form the information support of the optimization system for beneficiation processes with operational data on their parameters. The work [8, 9] presents the results of systematic studies on the characteristics of flocculation, sedimentation and consolidation of ore tailings using different polyacrylamide flocculants. The same disadvantage as in the above-mentioned approach is the use of chemical action on the processes of thickening and desliming, which complicates the operational control of the processes. In work [10], the influence of the characteristics of ultrasonic radiation: frequency, power, exposure time (5-20 min) on the final concentration of thickener sands and flocculation processes in this unit is considered. It has been found that ultrasound can significantly improve the concentration of the discharge, and its frequency and power are the most important factors of influence. In [11, 12], the processes of processing a suspension using ultrasound and its effect on electrochemical and flocculation processes to increase the efficiency of deposition processes were studied. However, the application of the above methods of ultrasonic exposure to the processes of thickening in the processing of several mineral and technological varieties of ore requires additional research [13-15].

3. Proposed methodology

The idea of the method is that increasing the efficiency of thickening and desliming processes of iron ore beneficiation products can be achieved by the spatial influence of dynamic effects of high-energy ultrasound with controlled characteristics on the ore pulp solid-phase particles in the deslimer input product. This allows us to predict the characteristics of their gravitational deposition based on the assessment of the spatial dynamics of the pulp solid-phase particles under the controlled action of high-energy ultrasound and fuzzy logic inference [16-18].

Let's evaluate the effect of ultrasonic radiation pressure on the change in the concentration of particles with radius r . Let the pulp with the velocity of V flow in the positive direction of the X -axis. Let's denote by $n_r(Z,t)$ the concentration of the particles of radius r at the depth Z at the moment of t . Considering the work [19-21] the equation will look as follows

$$\frac{\partial n_r(Z,t)}{\partial t} = -\frac{\partial}{\partial Z} [V_r(Z,t)n_r(Z,t)]. \quad (1)$$

where $V_r(Z,t)$ – is the velocity of the particle displacement of radius r , and the coordinate Z in the ultrasound field. The velocity is directed along the Z -axis, that is, it is perpendicular to the pulp flow.

Assuming that the intensity of the ultrasonic wave I varies exponentially (the initial value), its attenuation coefficient α depends on a sound frequency ν_0 and taking to account the analysis of works [20, 22], the particle concentration $n_r(Z,t)$ is determined as follows

$$n_r(Z,t) = n_0 \frac{e^{\alpha z}}{e^{\alpha z} - \alpha \beta t} St(e^{\alpha z} - 1 - \alpha \beta t), \quad (2)$$

where $n_r(Z,0) = n_0$, $n_r(0,t) = 0$ - are the initial and boundary conditions; $St(X) = \begin{cases} 0, & X < 0 \\ 1, & X \geq 0 \end{cases}$;

$\beta = \frac{2r(kr)^4}{27\eta c} I_0 (a_1^2 + a_1 a_2 + \frac{3}{4} a_2^2)$; $a_1 = 1 - \frac{rc^2}{\rho_s c_s^2}$; $a_2 = 2 \frac{\rho_s - \rho}{2\rho_s + \rho}$; ρ_s, c_s – are the particle density and ultrasound speed in particle material; ρ, c – the density of the medium under study and the speed of ultrasound in it.

The calculation of the high-energy ultrasound power, which allows the predicted displacement of particles of crushed ore of a certain mass in the pulp flow, was carried out based on the results obtained from the study of the ultrasonic pulse front propagation using a HIFU Simulator v1.2 [23] (Figure 1).

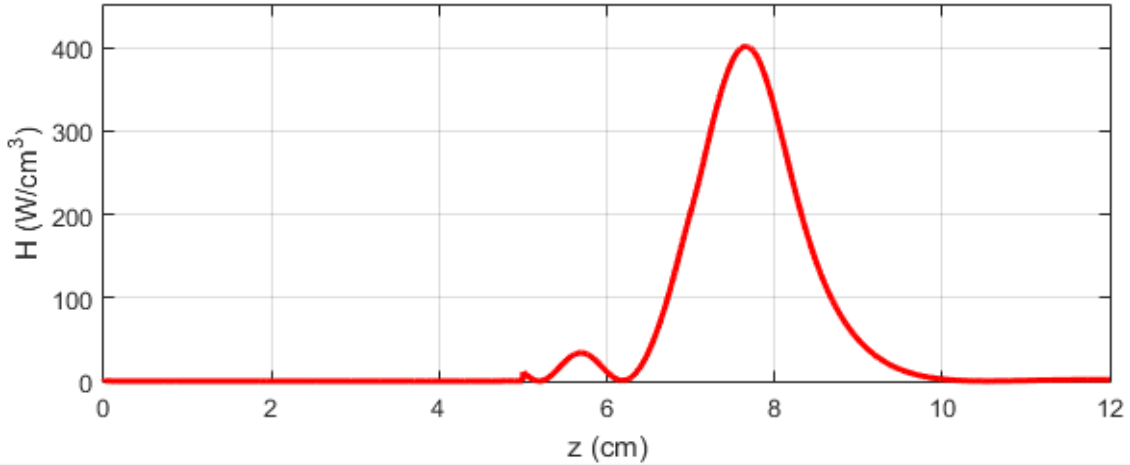

Figure 1: The ultrasonic power along the z -axis.

All grain sizes of the crushed material can be shifted under the increase in the high-energy ultrasound intensity I_h from zero to a specific value and a constant flow rate of pulp in the zone of measurement, sequentially [20, 24, 25]

$$\bar{\gamma}_i = \int_{d_i}^{d_{i+1}} \gamma(d) dd. \quad (3)$$

In this case, the average content of the useful component in this fraction is equal to

$$\bar{\beta}_i = \bar{\gamma}_i^{-1} \int_{d_i}^{d_{i+1}} \beta(d) \gamma(d) dd. \quad (4)$$

The concentration of the pulp solid phase in the measurement zone is determined using ultrasonic measurements and the density of its particles using gamma radiation in the radiometric measuring channel.

A signal S_γ is generated in the radiometric channel based on measurements of the gamma radiation attenuation in water I_w and pulp I_p

$$S_\gamma = \ln(I_w/I_p) = AW[(\rho_s \mu_s - \rho_w \mu_w)l], \quad (5)$$

where A – is the coefficient of proportionality; μ_w i μ_s – are the mass attenuation coefficients of water and ore pulp material; ρ_w and ρ_s – density of water and particles of ore pulp material, kg/m^3 ; W – is the ore particle volume fraction in the pulp.

The low-frequency ultrasonic waves were used for measurements of the pulp solid phase concentration. As shown in [20, 23, 26], the amplitude of the ultrasonic wave with frequency ν , which passed in the pulp distance z , can be described as follows

$$A_\nu(z) = A_w \exp \left\{ -\frac{zn}{\nu} \int_0^{r_m} \sigma(\nu, r) f(r) dr \right\}, \quad (6)$$

where n - the number of particles in the effective control volume of the pulp; A_B – is the amplitude of the wave passing the distance z in pure water; r_m - the maximum size of solid particles; $\sigma(\nu, r)$ – is the total attenuation coefficient of ultrasound on a particle of radius r .

The value $\sigma(\nu, r)$ is determined by the sum of the coefficients of ultrasound absorption and scattering

$$\sigma(\nu, r) = \sigma_c(\nu, r) + \sigma_s(\nu, r) \quad (7)$$

The graphs of the dependences of the ultrasonic wave attenuation α on the frequency, which obtained using the software package k-Wave Toolbox are presented in Figure 2. The value of y determines the acoustic density of the medium.

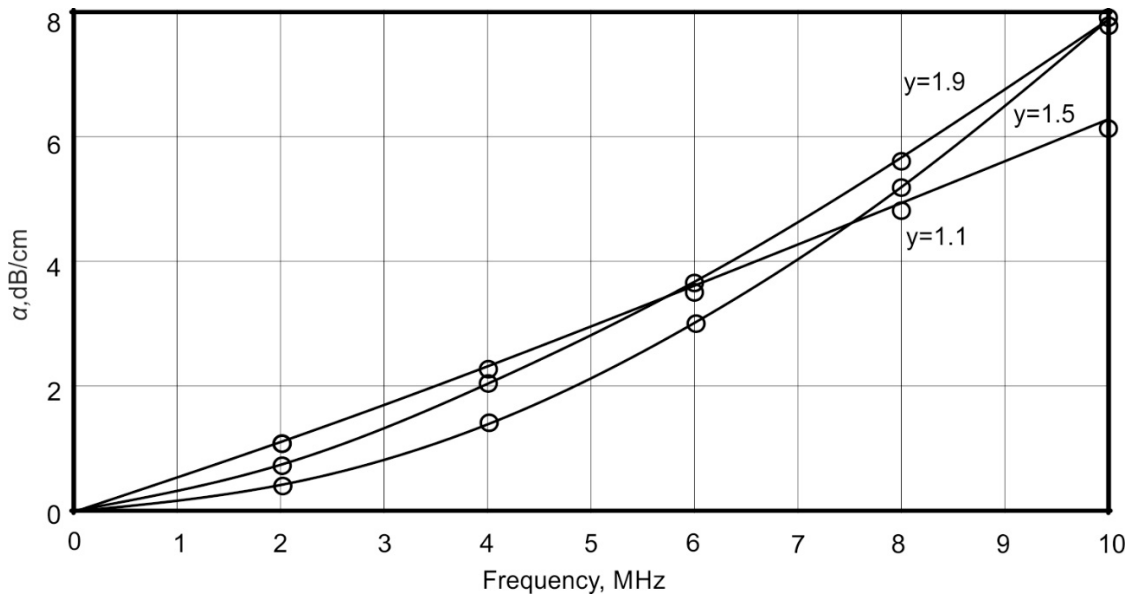

Figure 2: The dependences of the ultrasonic wave attenuation α on frequency during propagation in a homogeneous medium

In the region of low-frequency ($\nu \leq 10^6$ Hz) the ultrasound attenuation is mainly due to viscous inertial losses, so the ultrasound attenuation cross-section σ_c at this frequency ν_1 is determined only by the pulp solid phase concentration W and doesn't depend on the ore particle size distribution $F(r)$. The signal S_1 is obtained from measurements of the amplitude of the ultrasonic waves that have passed the distance z in water A_{0_1} and pulp A_{ν_1} determines the pulp solid phase concentration

$$S_1 = \ln(A_{0_1}/A_{\nu_1}) = \frac{Wz}{\nu} \int_0^{r_m} \sigma(\nu_1, r) F(r) dr, \quad (8)$$

In this expression

$$N = 4/3 \pi r^3 \int_0^{r_m} F(r) dr. \quad (9)$$

The ratio of S_7 (5) and S_1 (8) depends only on the density of the pulp solid phase particles in the zone of measurements and determines the useful component content in certain grades of particle size of crushed ore

$$S_4 = B \frac{S_7}{S_1}, \quad (10)$$

where B – is the coefficient of proportionality; S_7 – is the signal that depends on the concentration and density of solid-phase particles; S_1 – is the signal proportional to the solid phase concentration in the pulp.

The use of a measuring channel based on high-frequency ultrasonic waves [20, 21, 28] allows the measurement of the size control class content of the crushed ore. In the high-frequency range, with $\sigma(v_2, r) \approx \sigma_s$, the value

$$S_2 = \ln(A_{0_2}/A_{v_2}) = Z_2 N \int_0^{r_m} F(r) \sigma_s(v_1, r) = \frac{Z_2 W}{\mathfrak{N}} \int_0^{r_m} F(r) \sigma_s(v_2, r) dr \quad (11)$$

is measured. Then the ratio

$$S_3 = S_2/S_1 \quad (12)$$

doesn't depend on the pulp solid-phase concentration and is determined only by the concentration of the ore particle size control class [20, 21].

The cyber-physical system and program for modelling the crushed ore fraction redistribution in the ore pulp under the influence of the high-energy ultrasound radiation pressure according to the above expressions were developed. The program main window is shown in Figure 3. The program allows to vary the crushed ore particle density in the specified size ranges. The geometry of the measurements, the position of the source and the ultrasonic vibration intensity, the concentration of solid-phase particles and their size distribution before the simulation are set.

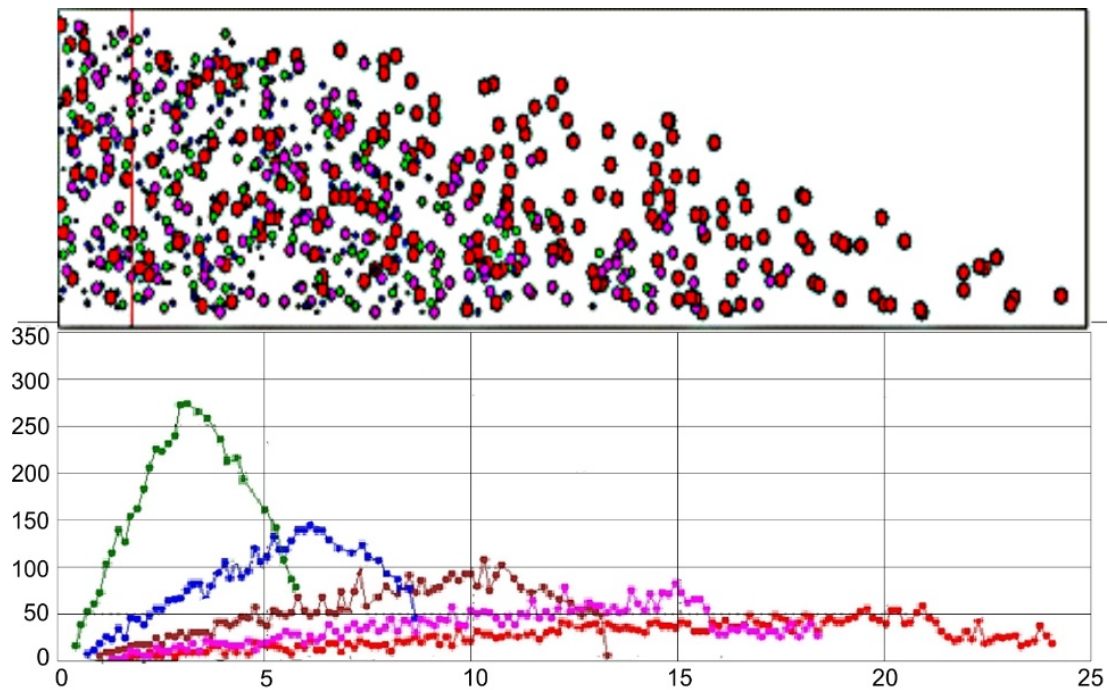

Figure 3: Redistribution of crushed ore particles in the pulp under the influence of high-energy ultrasound

The simulated measurement area is represented by a measuring container. The length and diameter of the container can be changed and is directly related to the strength of the ultrasound radiation pressure, which is determined by the intensity of ultrasound radiation generated by the emitter (source). The measurement range is the number (set) of sections of the measurement zone in which the number of particles falling into them is counted. The ordinate axis (Figure 3) displays the number

of processed particles, and the output scale automatically expands as the simulation time increases, i.e. the number of passing particles.

The proposed method for evaluating the distribution function of the useful component by size classes of crushed ore particles in a pulp flow, which based on measurements of the parameters of the propagation of high-frequency and low-frequency ultrasonic waves, as well as gamma radiation, differs from the existing ones in that during the measurements, the crushed ore particles of a certain size and density are displaced into the measurement area by exposing the pulp to high-energy ultrasound. The obtained results make it possible to predict the distribution of the iron ore solid phase in terms of size and density (the content of the useful component) in the deslimmer initial product and to form control actions on this basis.

4. Results

Practical approbation of the developed theoretical, algorithmic and program-technical decisions was carried out on experimental-industrial installations, experimental and production base of the enterprises of Association "Ukrudprom" and "Rudpromgeofizika". The technical means of ultrasonic and radiometric control were connected to a computer using a high-precision 24-bit analogue-to-digital converter ZET 230 via a USB 2.0 interface [29]. The conversion frequency on each channel of the ZET 230 module is up to 100 kHz, the maximum input voltage is ± 10 V, the supported exchange rates are from 75 to 115200 bps. In a frequency range of 10 Hz ... 20 kHz and a dynamic range of 100 dB, the maximum unevenness of the amplitude-frequency characteristic of the ZET 230 module is 1 dB.

The evaluation of the crushed ore particle distribution function by size and density (the useful component content) was carried out by evaluating their redistribution in the pulp flow under the influence of radiation pressure of high-energy ultrasound. In this case, the intensity of ultrasonic waves with a frequency of 5 MHz and 1 MHz, as well as gamma radiation transmitted through the studied medium was determined. The measurement configuration and hardware implementation in this part of the experiments performed corresponding to the methodology given in [20].

The signal recorded by the ultrasonic granulometer "Pulsar" [20], corresponding to the change in the particle size in the controlled volume of the pulp under the influence of the radiation pressure of high-energy ultrasound is shown in Figure 4. In the original undisturbed medium, the density of the pulp was 1250 g/l, and the content of the class $-74 \mu\text{m}$ was 80%.

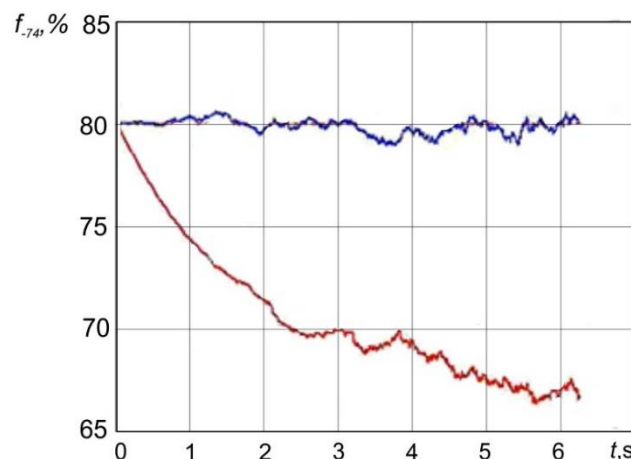

Figure 4: The changes in the size of particles in a controlled volume of ore pulp under the influence of high-energy ultrasound radiation pressure

The identification of the obtained dependencies at the stage of laboratory research was carried out using the MATLAB 7.0 software [30]. The Fuzzy Logic Toolbox, which is part of the MATLAB system, contains a set of GUI modules that provide the structural identification stage in an interactive mode. At this stage, the number of inputs and outputs of the model is determined, the number of terms and types of accessory functions is set, and the knowledge base is formed.

The knowledge base was formed directly from the results of measurements of S_1 according to (8) (concentration of the pulp solid phase), the value S_3 following (12) (concentration of the control class of the pulp solid phase particle size), the value S_4 following (10) (the density of particles of the pulp solid phase) and the signal corresponding to the current value of the acoustic power radiated into the pulp flow by the working waveguide.

As the last value, the value of the electric power supplied to the load by the ultrasonic emitter was used. A three-term lattice partitioning algorithm was used to evaluate each input variable with a Gaussian membership function. The structure of the model is shown in Figure 5.

The task of the model example was to reproduce the distribution of the useful component by the size fractions and the granulometric (sieve) characteristics of the desliming products. The fuzzy model is optimized for a training set of 1250 numeric input-output arrays. For each of the 25 prepared samples in the automatic mode, 50 cycles of measurements of the controlled parameters were performed. The measured values were presented in the standard potential form 0-10 V: acoustic power signal radiated into the pulp flow by the working waveguide (input1); pulp solids concentration signal (input2); control signal of the particle size concentration in the pulp solid phase (input3); particle density signal of the pulp solid phase (input4). The results of training the model are shown in Figure 6.

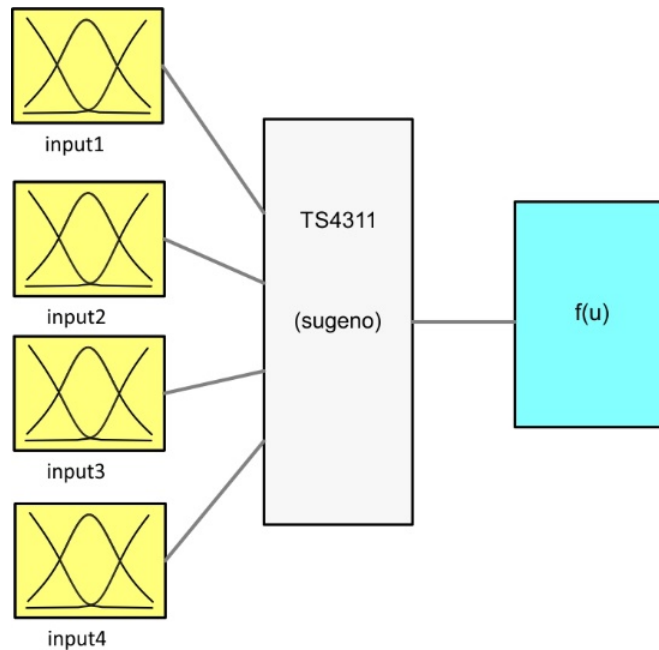

Figure 5: Structural diagram of the fuzzy model TS4311

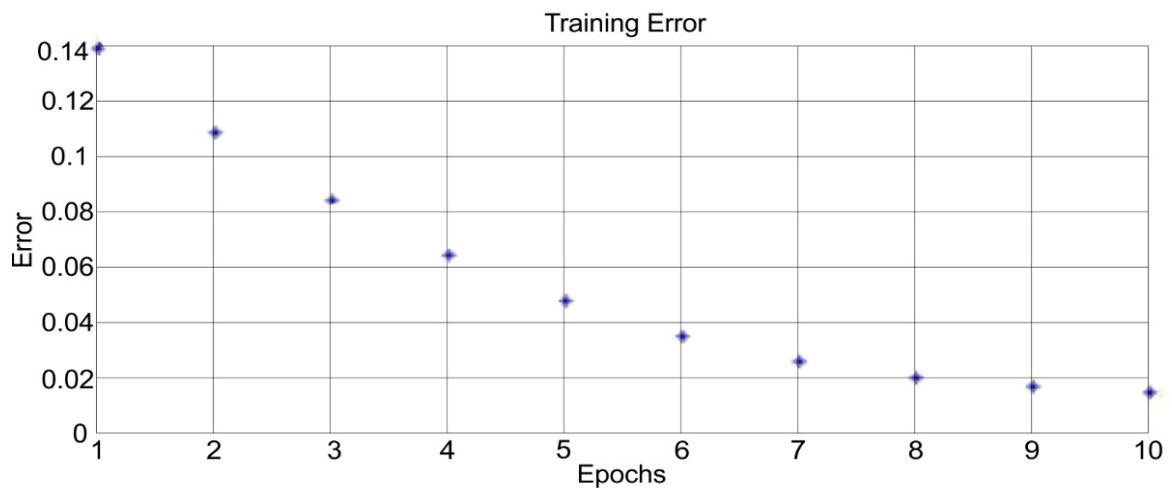

Figure 6: Training results of the TS4311 model

The granulometric (sieve) characteristics of the desliming discharge and the distribution of iron by size fractions restored following the simulation results are shown in Figure 7. It also shows a graphical display of the reconstruction error (for the convenience of analysis of Figure 7, the error value is doubled). The mean square error of identification of this model on a control sample of 10 points is 2.01.

The performed analysis confirmed the reproducibility of the results obtained. The developed method and the hardware-software complex that implements it makes it possible to correctly restore the function of crushed ore particles in terms of size and density, as well as to identify and form a curve of the separation efficiency of the desliming based on this function. The resulting dependencies were used to initialize the hybrid fuzzy model of the desliming, which was used to assess the state of the control object and form control actions.

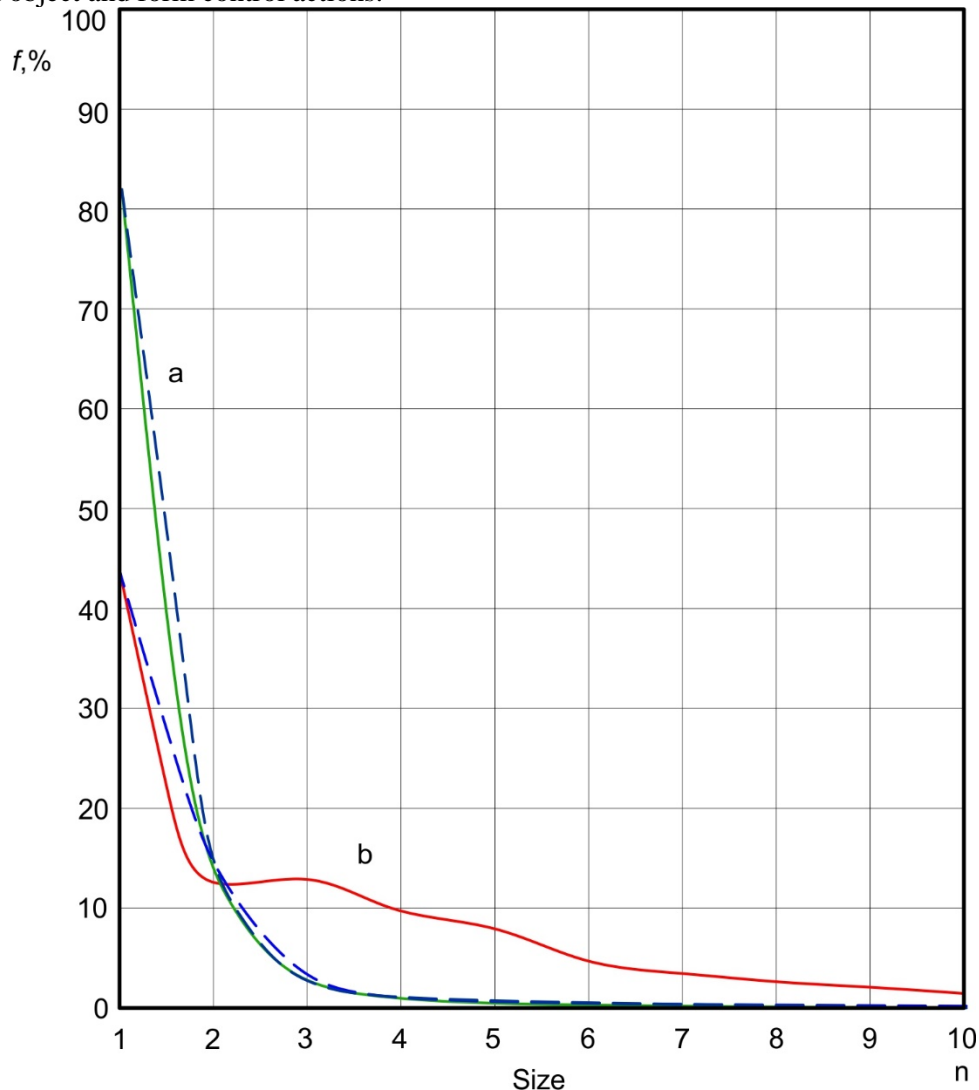

Figure 7: The results of modelling the granulometric characteristics of the desliming discharge (a) (a standard set of sieves $n = 10$ from 44 microns to 1651 microns), as well as the distribution of iron by size fractions (b).

5. Conclusion

The developed cyber-physical system for evaluating the efficiency of the iron ore desliming process ensures the formation and maintenance of the necessary characteristics (particle size distribution and particle density) of iron ore in its discharge by forming control actions based on the results of ultrasonic and radiometric measurements of pulp parameters and fuzzy inference. This allows to reduce the operating time of technological units outside their optimal characteristics and

thereby ensures the achievement of the target beneficiation indicators while maximizing productivity and energy efficiency. The error in restoring the distribution function of crushed material particles in terms of size and density in the standard deviation is 1.8 - 2.35%.

The results obtained were used in the construction and development of technical and algorithmic support for ACSs of technological processes at the mining enterprises of the Association "Ukrudprom".

6. References

- [1] R. Arjmand, M. Massinaei, A. Behnamfard, Improving flocculation and dewatering performance of iron tailings thickeners, *Journal Of Water Process Engineering*. 31 (2019) 100873. doi:10.1016/j.jwpe.2019.100873.
- [2] M. Garmsiri, M. Unesi, Challenges and opportunities of hydrocyclone-thickener dewatering circuit: A pilot scale study, *Minerals Engineering*. 122 (2018) 206-210. doi:10.1016/j.mineng.2018.04.001.
- [3] S. Tripathy, Y. Murthy, S. Farrokhpay, L. Filippov, Design and analysis of dewatering circuits for a chromite processing plant tailing slurry, *Mineral Processing And Extractive Metallurgy Review*. 42 (2019) 102-114. doi:10.1080/08827508.2019.1700983.
- [4] P. Fawell, T. Nguyen, C. Solnordal, D. Stephens, Enhancing Gravity Thickener Feedwell Design and Operation for Optimal Flocculation through the Application of Computational Fluid Dynamics, *Mineral Processing And Extractive Metallurgy Review*. (2019) 1-15. doi:10.1080/08827508.2019.1678156.
- [5] X. Chen, X. Jin, H. Jiao, Y. Yang, J. Liu, Pore Connectivity and Dewatering Mechanism of Tailings Bed in Raking Deep-Cone Thickener Process, *Minerals*. 10 (2020) 375. doi:10.3390/min10040375.
- [6] G. Liang, Q. Zhao, B. Liu, Z. Du, X. Xia, Treatment and reuse of process water with high suspended solids in low-grade iron ore dressing, *Journal Of Cleaner Production*. 278 (2021) 123493. doi:10.1016/j.jclepro.2020.123493.
- [7] C. Wang, J. Ding, R. Cheng, C. Liu, T. Chai, Data-Driven Surrogate-Assisted Multi-Objective Optimization of Complex Beneficiation Operational Process, *IFAC-Papersonline*. 50 (2017) 14982-14987. doi:10.1016/j.ifacol.2017.08.2561.
- [8] R. Dwari, S. Angadi, S. Tripathy, Studies on flocculation characteristics of chromite's ore process tailing: Effect of flocculants ionicity and molecular mass, *Colloids And Surfaces A: Physicochemical And Engineering Aspects*. 537 (2018) 467-477. doi:10.1016/j.colsurfa.2017.10.069.
- [9] A. Leite, É. Reis, Cationic starches as flocculants of iron ore tailing slime, *Minerals Engineering*. 148 (2020) 106195. doi:10.1016/j.mineng.2020.106195.
- [10] L. Zhu, W. Lyu, P. Yang, Z. Wang, Effect of ultrasound on the flocculation-sedimentation and thickening of unclassified tailings, *Ultrasonics Sonochemistry*. 66 (2020) 104984. doi:10.1016/j.ultsonch.2020.104984.
- [11] Y. Zhao, L. Meng, X. Shen, Study on ultrasonic-electrochemical treatment for difficult-to-settle slime water, *Ultrasonics Sonochemistry*. 64 (2020) 104978. doi:10.1016/j.ultsonch.2020.104978.3.
- [12] R. Jia, B. Zhang, D. He, Z. Mao, F. Chu, Data-driven-based self-healing control of abnormal feeding conditions in thickening-dewatering process, *Minerals Engineering*. 146 (2020) 106141. doi:10.1016/j.mineng.2019.106141.
- [13] Y. Mikhlin, S. Vorobyev, A. Romanchenko, S. Karasev, A. Karacharov, S. Zharkov, Ultrafine particles derived from mineral processing: A case study of the Pb-Zn sulfide ore with emphasis on lead-bearing colloids, *Chemosphere*. 147 (2016) 60-66. doi:10.1016/j.chemosphere.2015.12.096.
- [14] T. Leistner, U. Peuker, M. Rudolph, How gangue particle size can affect the recovery of ultrafine and fine particles during froth flotation, *Minerals Engineering*. 109 (2017) 1-9. doi:10.1016/j.mineng.2017.02.005.

- [15] J. Carpenter, S. Iveson, K. Galvin, Ultrafine desliming using a REFLUX™ classifier subjected to centrifugal G forces, *Minerals Engineering*. 134 (2019) 372-380. doi:10.1016/j.mineng.2019.02.013.
- [16] E. Matiolo, H. Couto, N. Lima, K. Silva, A. de Freitas, Improving recovery of iron using column flotation of iron ore slimes, *Minerals Engineering*. 158 (2020) 106608. doi:10.1016/j.mineng.2020.106608.
- [17] V. Morkun, S. Semerikov, S. Hryshchenko, K. Slovak, Environmental geo-information technologies as a tool of pre-service mining engineer's training for sustainable development of mining industry, *CEUR Workshop Proceedings*. 1844 (2017) 303-310.
- [18] V. Morkun, N. Morkun, V. Tron, Distributed control of ore beneficiation interrelated processes under parametric uncertainty. *Metallurgical and Mining Industry*. 7(8) (2015) 18-21.
- [19] S. Rath, N. Dhawan, D. Rao, B. Das, B. Mishra, Beneficiation studies of a difficult to treat iron ore using conventional and microwave roasting, *Powder Technology*. 301 (2016) 1016-1024. doi:10.1016/j.powtec.2016.07.044.
- [20] V. Morkun, N. Morkun, Estimation of the crushed ore particles density in the pulp flow based on the dynamic effects of high-energy ultrasound, *Archives of Acoustics*. 43(1) (2018) 61-67.
- [21] V. Morkun, N. Morkun, A. Pikilnyak, The adaptive control for intensity of ultrasonic influence on iron ore pulp, *Metallurgical and Mining Industry*. 6(6) (2014) 8-11.
- [22] S. Mahiuddin, S. Bondyopadhyay, J. Baruah, A study on the beneficiation of indian iron-ore fines and slime using chemical additives, *International Journal Of Mineral Processing*. 26 (1989) 285-296. doi:10.1016/0301-7516(89)90034-3.
- [23] High intensity focused ultrasound simulator, Mathworks.com. (2021). https://www.mathworks.com/matlabcentral/fileexchange/30886-high-intensity-focused-ultrasound-simulator?s_tid=srchtitle (accessed 5 February 2020).
- [24] V. Morkun, N. Morkun, V. Tron, Model synthesis of nonlinear nonstationary dynamical systems in concentrating production using Volterra kernel transformation, *Metallurgical and Mining Industry*. 7(10) (2015) 6-9.
- [25] M. Mamina, R. Maganga, K. Dzwiti, An analysis of Zimbabwe's comparative advantage in the beneficiation and value addition of minerals, *Resources Policy*. 69 (2020) 101823. doi:10.1016/j.resourpol.2020.101823.
- [26] Y. Chen, V. Truong, X. Bu, G. Xie, A review of effects and applications of ultrasound in mineral flotation, *Ultrasonics Sonochemistry*. 60 (2020) 104739. doi:10.1016/j.ultsonch.2019.104739.
- [27] V. Golik, V. Komashchenko, V. Morkun, V. Zaalishvili, Enhancement of lost ore production efficiency by usage of canopies, *Metallurgical and Mining Industry* 7(4) (2015) 325-329.
- [28] O. P. Kreuzer, M. Yousefi, V. Nykänen, Introduction to the special issue on spatial modelling and analysis of ore-forming processes in mineral exploration targeting, *Ore Geology Reviews*. 119 (2020) 103391. doi:10.1016/j.oregeorev.2020.103391.
- [29] New ZET 230 ADC module, technical characteristics, news, ZETLAB. (2021). <https://zetlab.com/en/new-zet-230-adc-module/> (accessed 15 February 2021).
- [30] C. Besta, A. Kastala, P. Ginuga, R. Vadeghar, MATLAB Interfacing: Real-time Implementation of a Fuzzy Logic Controller, *IFAC Proceedings Volumes*. 46 (2013) 349-354. doi:10.3182/20131218-3-in-2045.00189.