

SIMULATION OF THE CONTROL SYSTEM FOR THE 12-PULSE BRIDGE RECTIFIERS OF ROLLING MILL'S DRIVES

SAVYTSKYI A.I., PhD, Associated Professor, SEMOCHKYN A.B., PhD, Associated Professor, SEMOCHKYNA S.V., PhD, Associated Professor
Kryvyi Rih National University

Abstract. This article made a study of various schemes' options and control algorithms for 12-pulse thyristor bridge rectifiers. While maintaining the same speed's modes were analyzed changes of the power factor and harmonic composition of current and voltage, as well as was assessed their level based on the IEEE 519-1992 standard. Simulation of the electric power system has been performed in the software environment Matlab. The aim of the job is to identify the most suitable ways of connecting and control thyristors schemes for improving power factor and harmonic composition of current and voltage. The results of the work will be put in a series of activities to effectively phase manage the rolling mill drives' distributed power converters.

Keywords. Electromagnetic compatibility, thyristor electric drive, compensated controlled rectifier, energy characteristics.

Introduction. If guided by international standards, such as IEEE 519-1992 [1], the energy parameters of the power network of the rolling mills' drives are currently characterized by exaggerated consumption of reactive power and saturation of harmonic components of voltage and current generated by the power equipment with semiconductors. As a consequence, there has been a decrease in service life of equipment and have happen emergency situations [2-3].

Therefore, this work aimed to assess the current level of network harmonics on its model, and then in real-time, and the development of activities to keep the levels of distortion within the specified range according to the standard, is very relevant. There are two approaches to solving this problem. One of them is the creation of more

advanced universal filters of highest harmonics for systems with multipulse rectifiers [4].

The second - is that in recent years observed the trend [5-6] of an integrated approach to the creation of more advanced topologies powerful rectifiers and their control systems to improve EMC converters with a power line. It allows to solve several problems simultaneously:

- to improve the energy indicators of the system (power factor, efficiency);
- to reduce the highest harmonics' content of the input current of the converter.

Materials and methods. This work is devoted to creating perfect topology power circuits powerful rectifiers and their control systems based on modeling in MatLab environment.

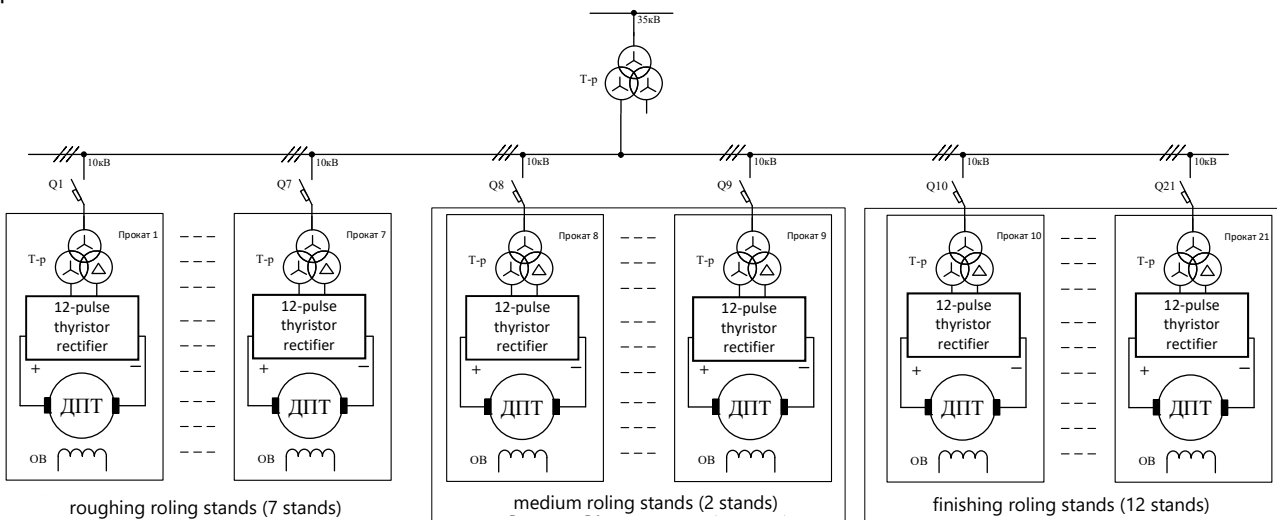

Figure 1. The power supply circuit for drives of the rolling line

Consider one of the existing options of drives' connection schemes for the line of rolling stands in rolling plant, which includes 21 rolling stands according to the scheme shown in Fig. 1.

The power factor and harmonic distortion for curves of voltage and current belong to the energy indicators on which pay attention in this article.

Results. Analyses of these indicators has been performed in relation to the five options of thyristor bridge rectifier's control system for a 12-pulse circuit irreversible thyristor drive. Investigation realized with the help of simulation in MatLab package (see Fig. 2). The following are structural diagrams of models for the study of energy performance.

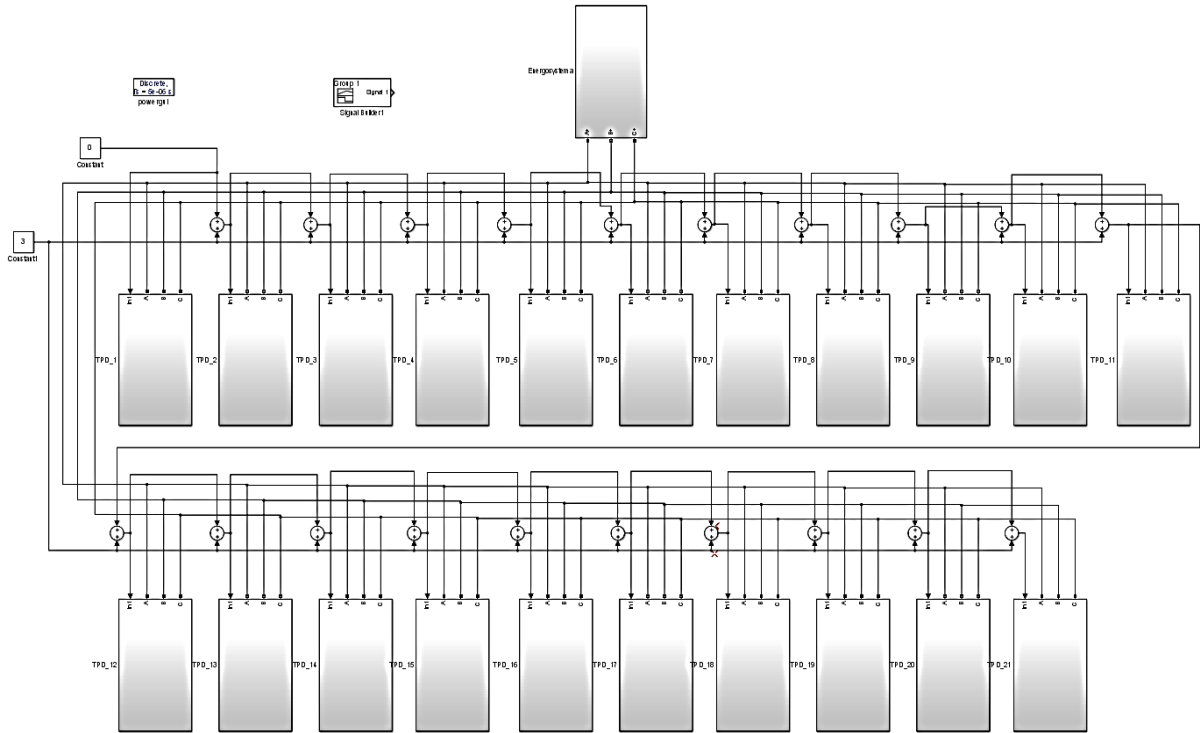

Figure 2. The model of the system of 21 drives with not symmetric control (one of the two secondary windings of the individual transformers for each drive are connected by wye, another - delta)

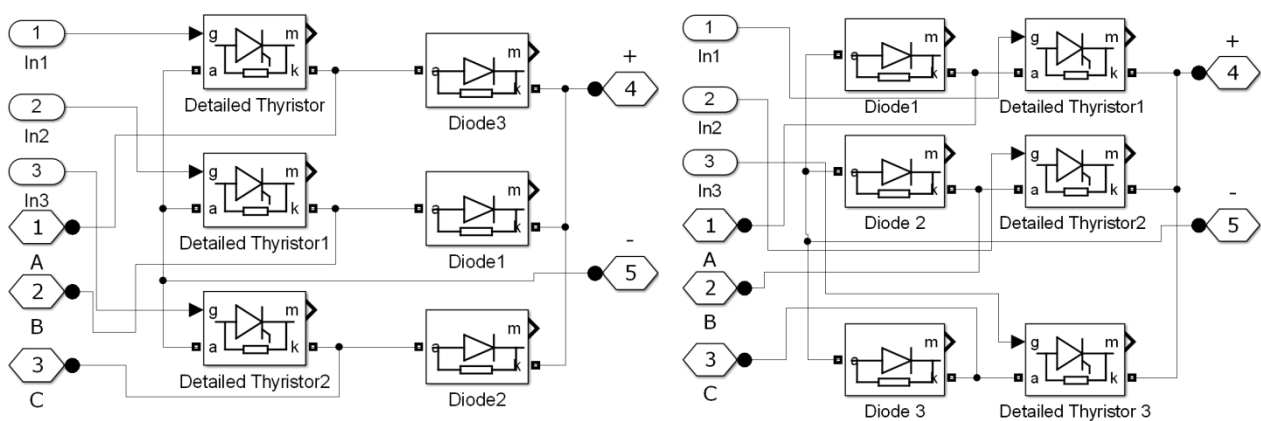

Figure 3. The drive's model where are not symmetrical bridges (have been controlled cathode and anode groups of thyristors)

First option. Not symmetric control - all the bridges are not symmetric (control pulses are applied to the cathode and the anode groups of different bridges).

Main indicators (speed, power factor and the spectral composition of the transformer's current and voltage) are shown in figures 4 -7.

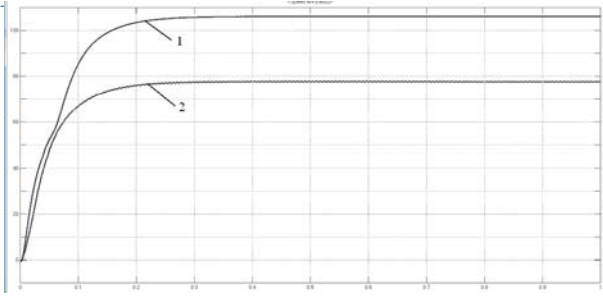

Figure 4. Charts speeds of stands with the moment of inertia is $50 \text{ kg}\cdot\text{m}^2$ (option 1): 1 - of the fastest (steady value is 106.1 s^{-1}); 2 - of the slowest (steady value is 77.5 s^{-1})

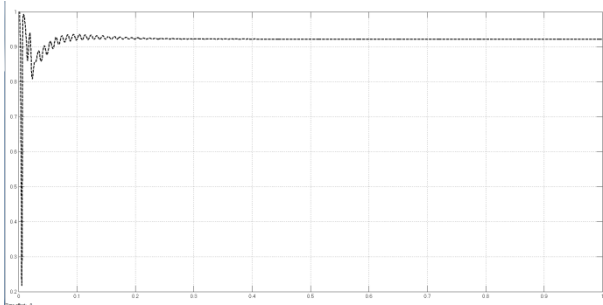

Figure 5. Power factor under work of the 21 stands with not symmetrical control ($K_m = 0.9223$)

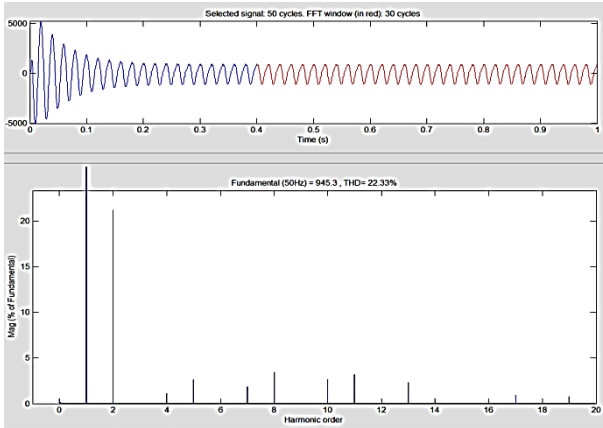

Figure 6. The spectral composition of 32 MVA transformer's secondary current ($\text{THDi} = 22.33\%$) under the work of 21 stand with not symmetrical control

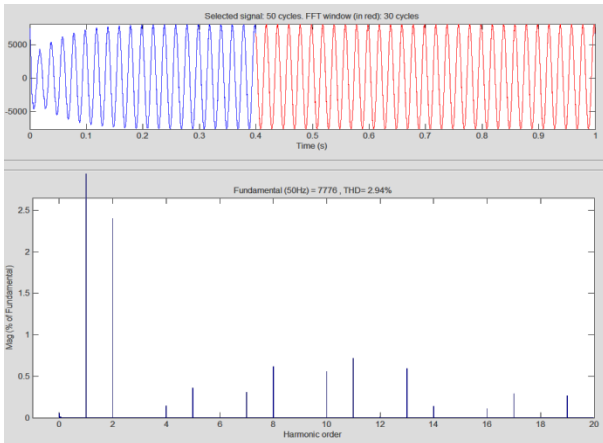

Figure 7. The spectral composition of 32 MVA transformer's secondary voltage ($\text{THDu} = 2.94\%$) under the work of 21 stand with not symmetrical control

Second option. Not symmetric control - all the bridges are not symmetric (control pulses are applied to the anode groups of different bridges)

The spectral composition of the transformer's current and voltage is shown in figures 8, 9.

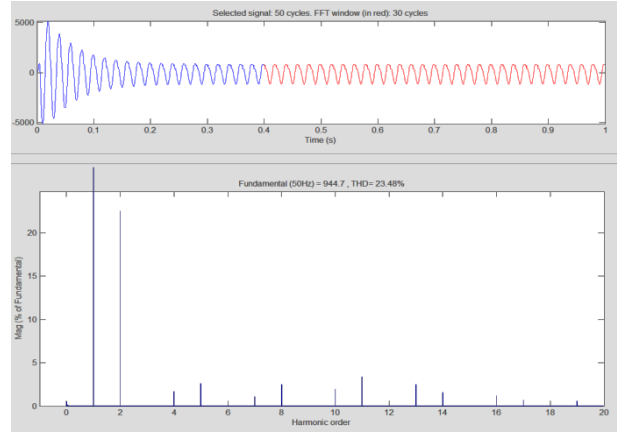

Figure 8. Spectral composition of the current $\text{THDi} = 22.48\%$

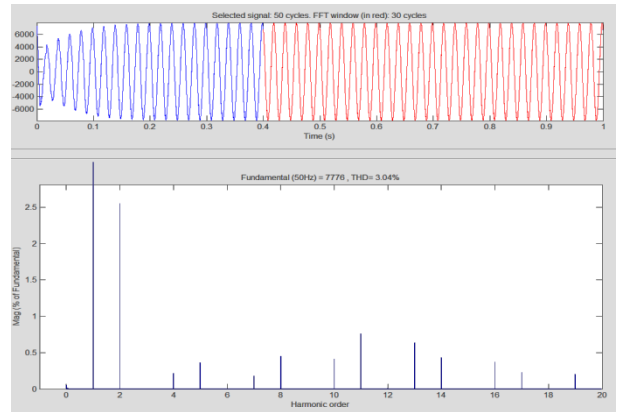

Figure 9. Spectral composition of the voltage $\text{THDu} = 3.04\%$

Third option. Not symmetric control - one bridge is completely controlled, the second is diode bridge.

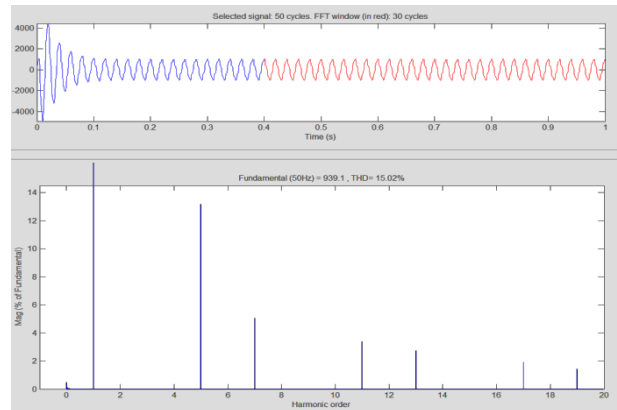

Figure 10. Spectral composition of the current $\text{THDi} = 15.02\%$

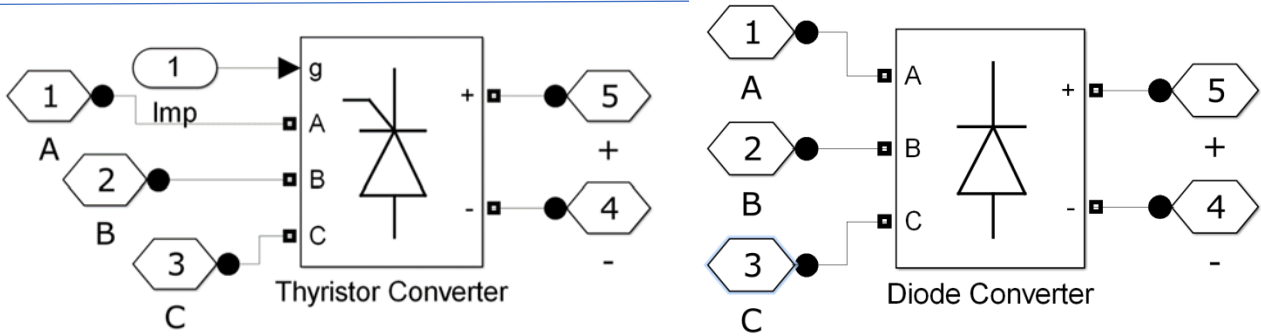

Figure 11. The drive's model where one bridge is completely controlled, the second is diode bridge

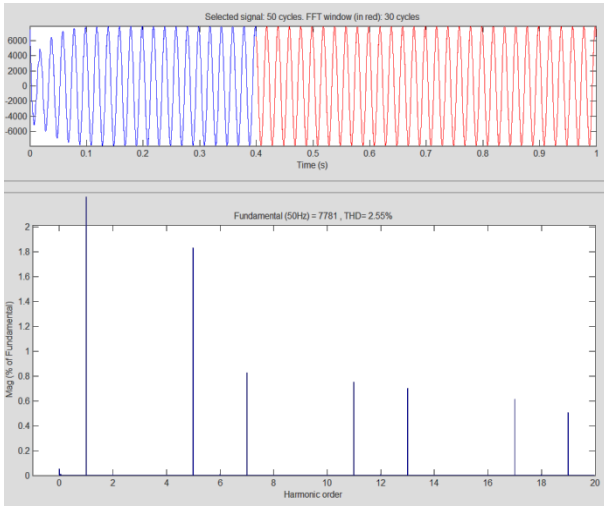

Figure 12. Spectral composition of the voltage THDu = 2.55%

Fourth option. Not symmetric control - first bridge is half-controlled and second diode bridge – uncontrollable. The spectral composition of the transformer's current and voltage is shown in figures 13, 14.

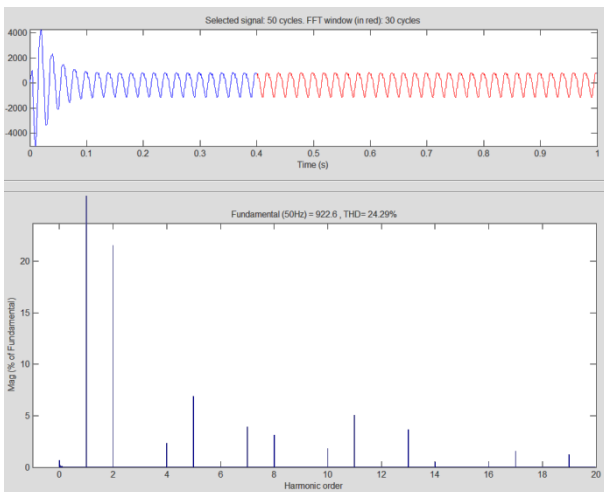

Figure 13. Spectral composition of the current THDi = 24.23%

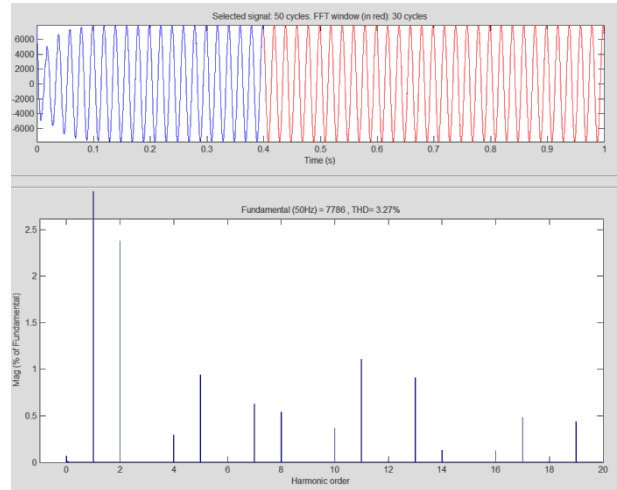

Figure 14. Spectral composition of the voltage THDu = 3.26%

Fifth option. All the bridges are controlled - symmetric control. The drive's model with two symmetric controlled bridges performed similarly to Figure 10 (model on the left)

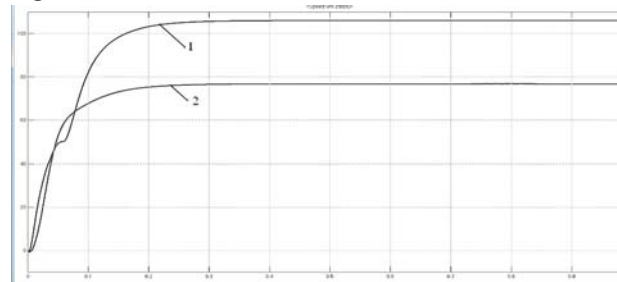

Figure 15. Charts speeds of stands with moment of inertia is 50 kg•m² (option 5): 1 - of the fastest (steady value is 106.1 s⁻¹); 2 - of the slowest (steady value is 77.5 s⁻¹)

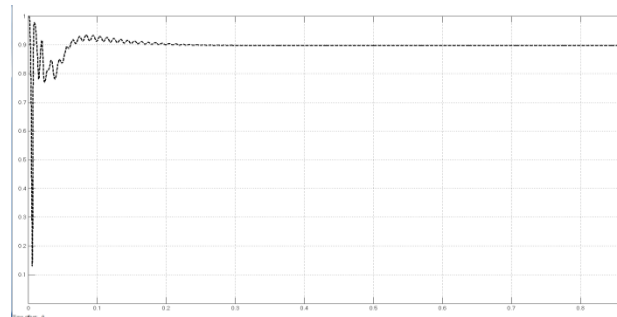

Figure 16. Power factor 0.8975 with the moment of inertia is 50 kg•m²

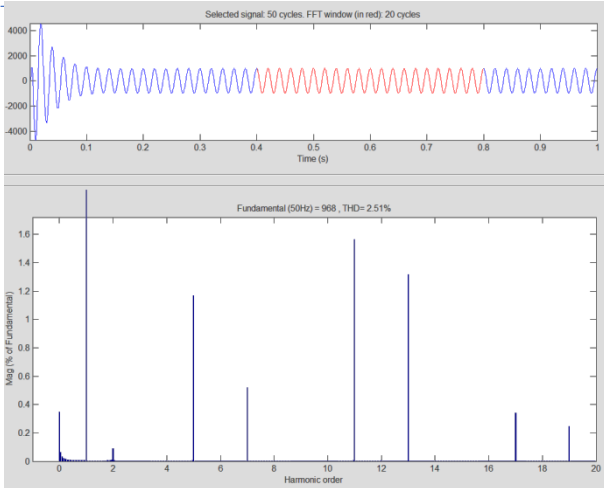

Figure 17. Spectral composition of the current THDi = 2.51%

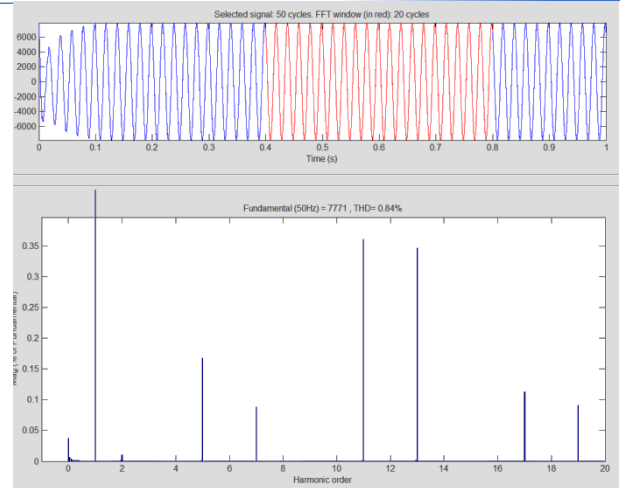

Figure 18. Spectral composition of the voltage THDu = 0.84%

For ease of comparison, in all cases firing angle chosen so as to provide the speed of the

slowest cage about 77.5 s^{-1} . Materials of investigations are summarized in Table 1.

Table 1. Comparative characteristics of energy indicators for the 12-pulse bridge rectifiers

	One bridge is not symmetric, the second diode	All bridges are not symmetric (only anode groups)	All bridges are not symmetric (anode and cathode groups)	One bridge is symmetric, the second diode	All bridges are symmetric
Power factor	0,9404	0,9228	0,9223	0,9235	0,8975
THDu	3,26	3,04	2,95	2,55	0,84
THDi	24,23	22,48	22,33	15,02	2,51

Conclusions In the outcome of the study was determined the trend of constructing circuits' topology of 12-pulse thyristor rectifier in terms of improving energy indicators. For improving the power factor, the most appropriate scheme is the circuit with series bridges one of which - unbalanced, and the other - an unmanaged or managed with the angle of 0 degrees.

All not symmetric circuits of 12-pulse bridges or with unmanaged bridges, when its work in the full speed range, characterized by not sinusoidal current's factors, exceeding the normative indicators by 3-5 times. With regard to specific results of this study, it is possible to note the following:

- the best for the power factor (0.9404) scheme with one not symmetric bridge (second diode bridge), but it is also the worst for THDi (24.29);

- the worst for the power factor (0.8975) is a fully balanced circuit, but all other indicators she has better than normative (in 5 times by the voltage and in 2 - by the current).

Further development of research possible by develop systems with more complex control algorithm with a hybrid control based on fuzzy logic [7-8].

References

1. Trovão J. P., Pereirinha P., Jorge H. IEEE Standard 519-1992 Application in Industrial Power Distribution Networks with a New Monitoring Approach. Proceeding of the 6th WSEAS International Conference on Power Systems, Lisbon, Portugal, September 22-24, 2006: 244-249.
2. Grady W.M. Gilleskie R. J. Harmonics and how they relate to power factor. Proc. of the EPRI Power Quality Issues & Opportunities Conference (PQA'93), San Diego, CA, November 1993.
3. Dugan R., Mcgranaghan M., Wayne H. Electrical Power Systems Quality. NewYork: McGraw-Hil, 1999.
4. Trovão J.P. Harmonic Distortion Monitoring and Analysis Integrated System a Systematic Approach for the

Industrial Sector. M.Sc Thesis, Faculty of Science and Technology of the University of Coimbra, Portugal, 2004.

5. Volkov I.V., Karshenov D.P., Podolnyiy C.V. (2014). Raschet parametrov universalnogo filtra vysshih garmonik dlya sistem s mnogopulsnyimi vyipryamitelyami. *Tehn. elektrodinamika*, **2**, 17-21

6. Butova O.A. (2009). Analiz printsipov postroeniya sistem upravleniya mnogopulsnyimi vyipryamitelyami. *Tekhnichna elektrodinamika*. Kyiv: Tem. vipusk "Silova elektronika ta energoefektivnist", **5**: 59-65.

7. Sokol E.I., Butova O.A., Shishkin M.A. (2014). Matlab-model 12-ti pulsnoho parallelnogo KUV s rozdelennym upravleniem. Natsionalnyy tekhnicheskyy universitet «Harkovskiy politehnicheskyy institut», *Energoberezhenie energetika energoaudit*, **9**(128): 101-106.

8. Zhilenkov A.A., ChYornyiy S.G. (2013). Modelirovanie adaptivnogo upravleniya v slozhnykh raspredelennykh sistemakh s identifikatsiyey parametrov. *Visnik Hmel'nitskogo natsionalnogo universitetu*, **6**: 253-260.

9. Prnya R., Chehov V.I. (1999). Kachestvo napryazheniya - novoe v reshenii problemy kompensatsii reaktivnoy moschnosti. *Elektrotehnika*, 32-34.

10. Rozanov Yu.K., Ryabchitskiy M.V. (1998). Sovremennyye metody uluchsheniya kachestva elektroenergii. *Elektrotehnika*: 10-17.

11. Rozanov Yu.K., Ryabchitskiy M.V., Kvasnyuk A.A. (1999). Sovremennyye metody regulirovaniya kachestva elektroenergii sredstvami silovoy elektroniki. *Elektrotehnika*, **24**: 28 - 32.

12. Soliman S.A., Christensen G.S., Kelly D.H. El-Naggar K.M. (1990). A State Estimation Algorithm for Identification and Measurements of Power System Harmonics. *Electric Power System Research Journal*, **19**: 195-206.

13. Hartana R.K., Richards G.G. (1990). Harmonic source monitoring and identification using neural networks. *IEEE Trans, on Power Systems*, **5**(4): 1098-1104.

14. Yagup V.G. (1983). Postroenie i ispolzovanie makromodeley avtonomnykh tiristornykh preobrazovateley. *Izv. ANSSSR. Energetika i transport*, **4**: 78-83.

15. Sokol E.I., Butova O.A., Shishkin M.A., NTU «Harkovskiy politehnicheskyy institut», Matlab-model 12-ti pulsnoho parallelnogo KUV s rozdelennym upravleniem. Sistemy upravleniya i kontrolya preobrazovatelyami elektroenergii **9**(128) September 2014, *Energoberezhenie Energetika Energoaudit*.